

Hard Paper
200-350 gsm

Transparent Plastic Sheet
150 micron

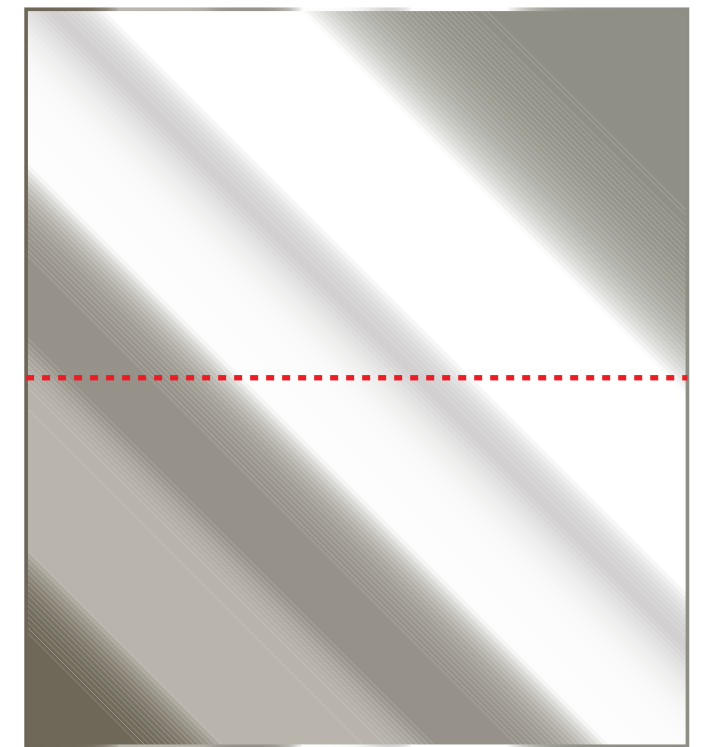

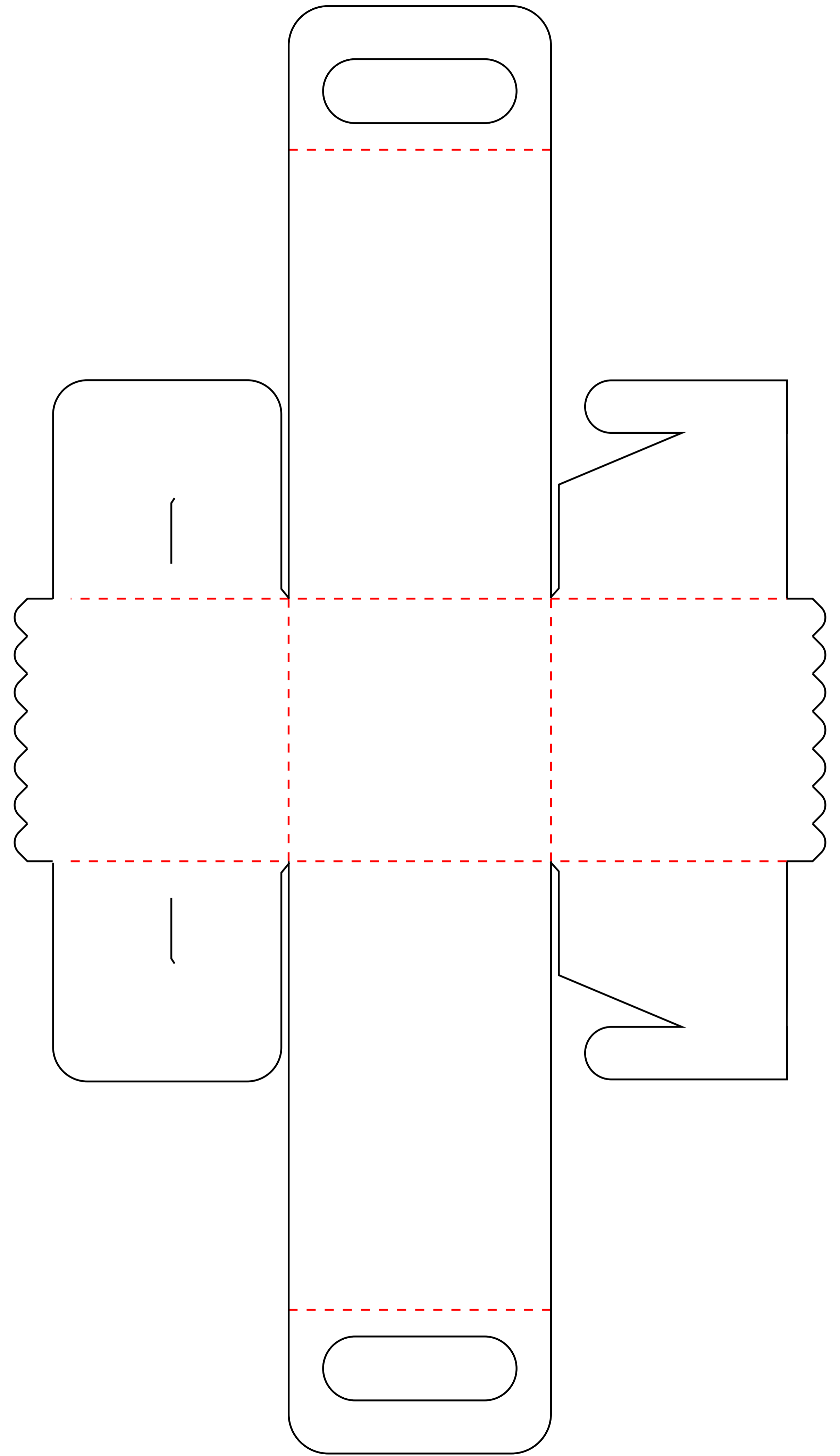

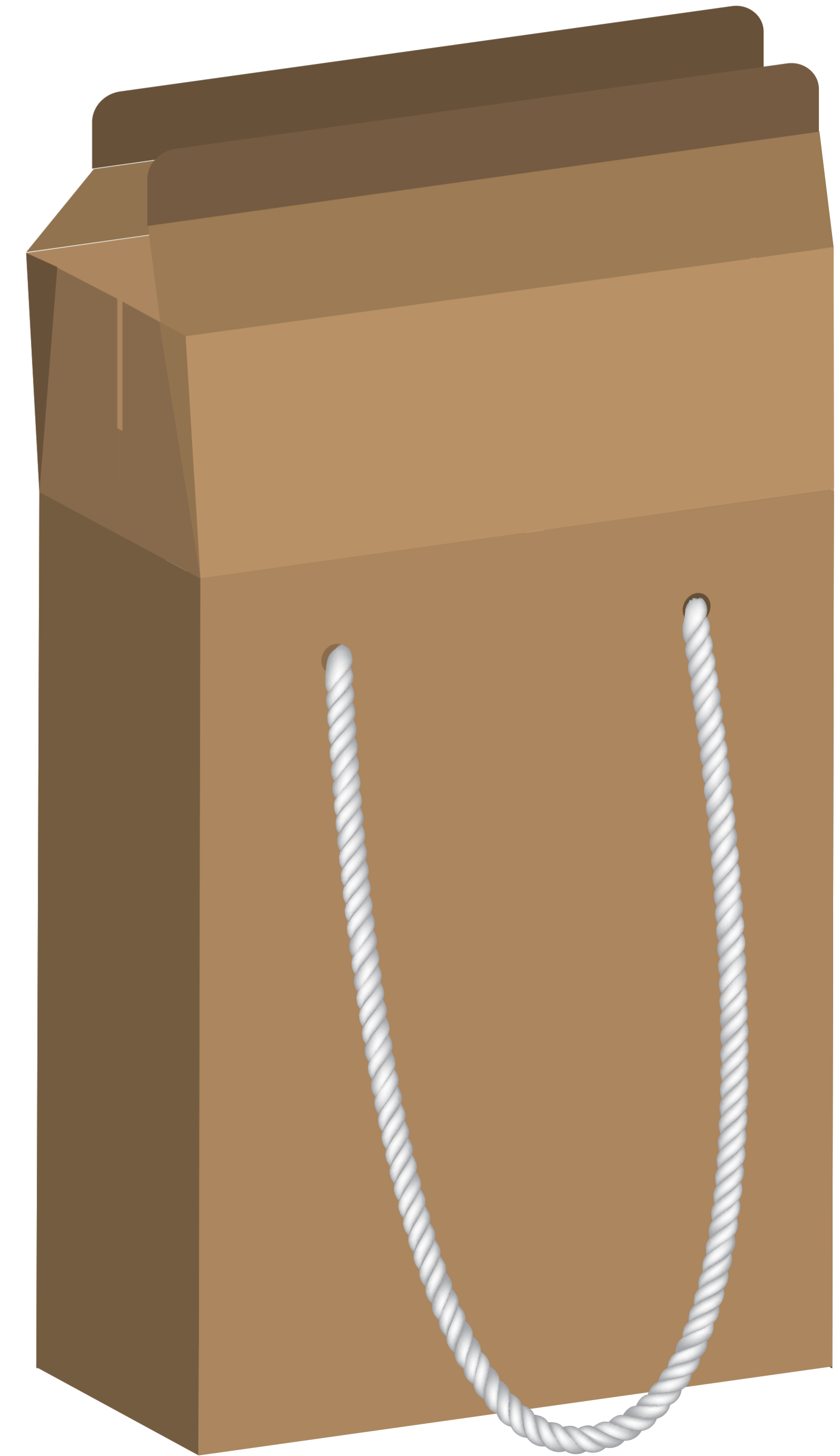
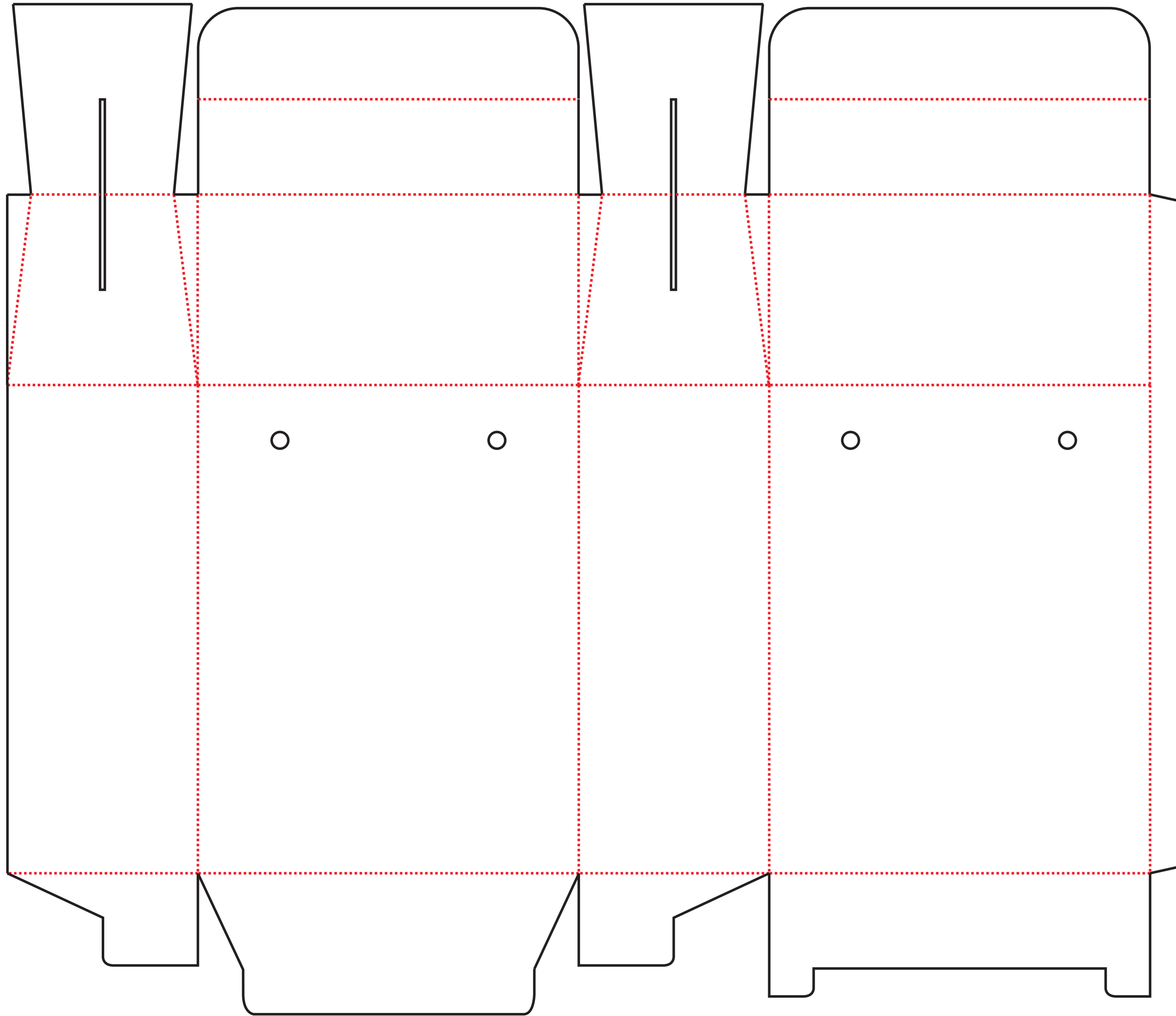

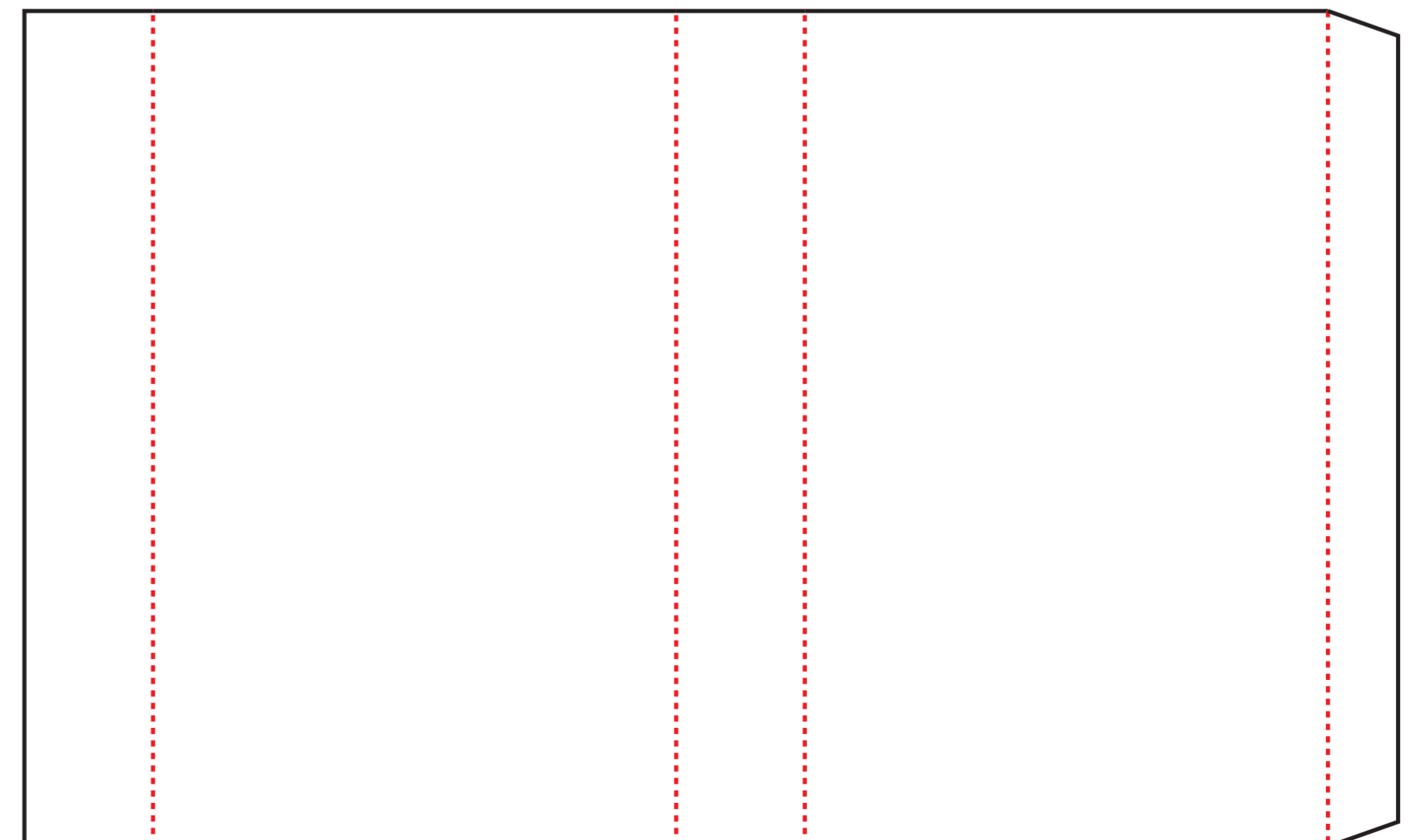
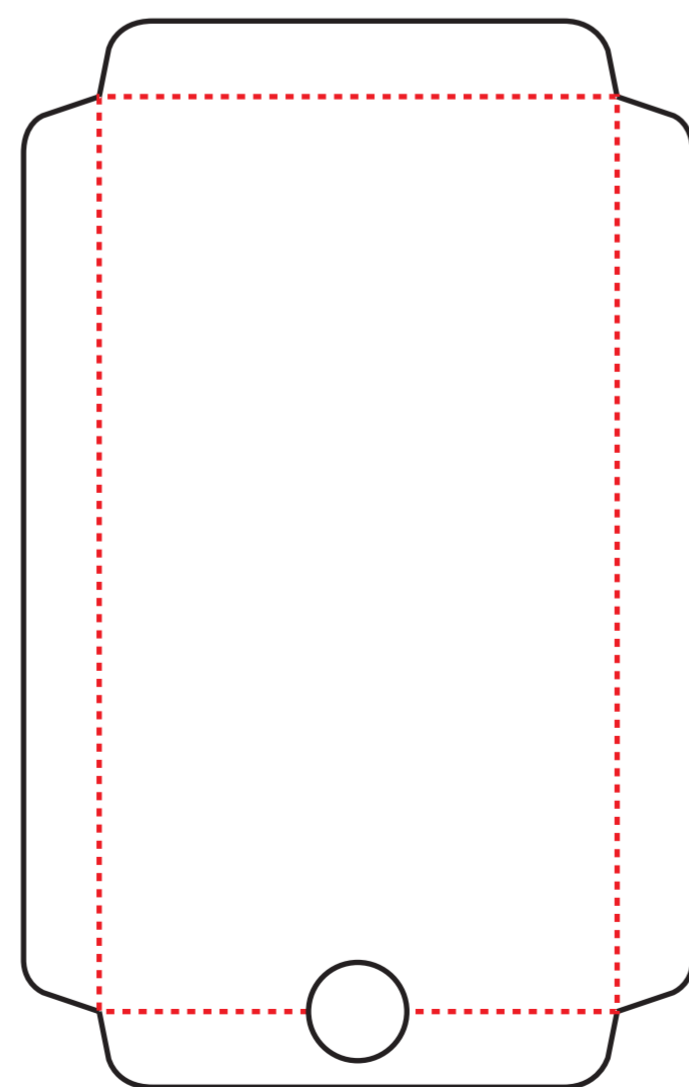
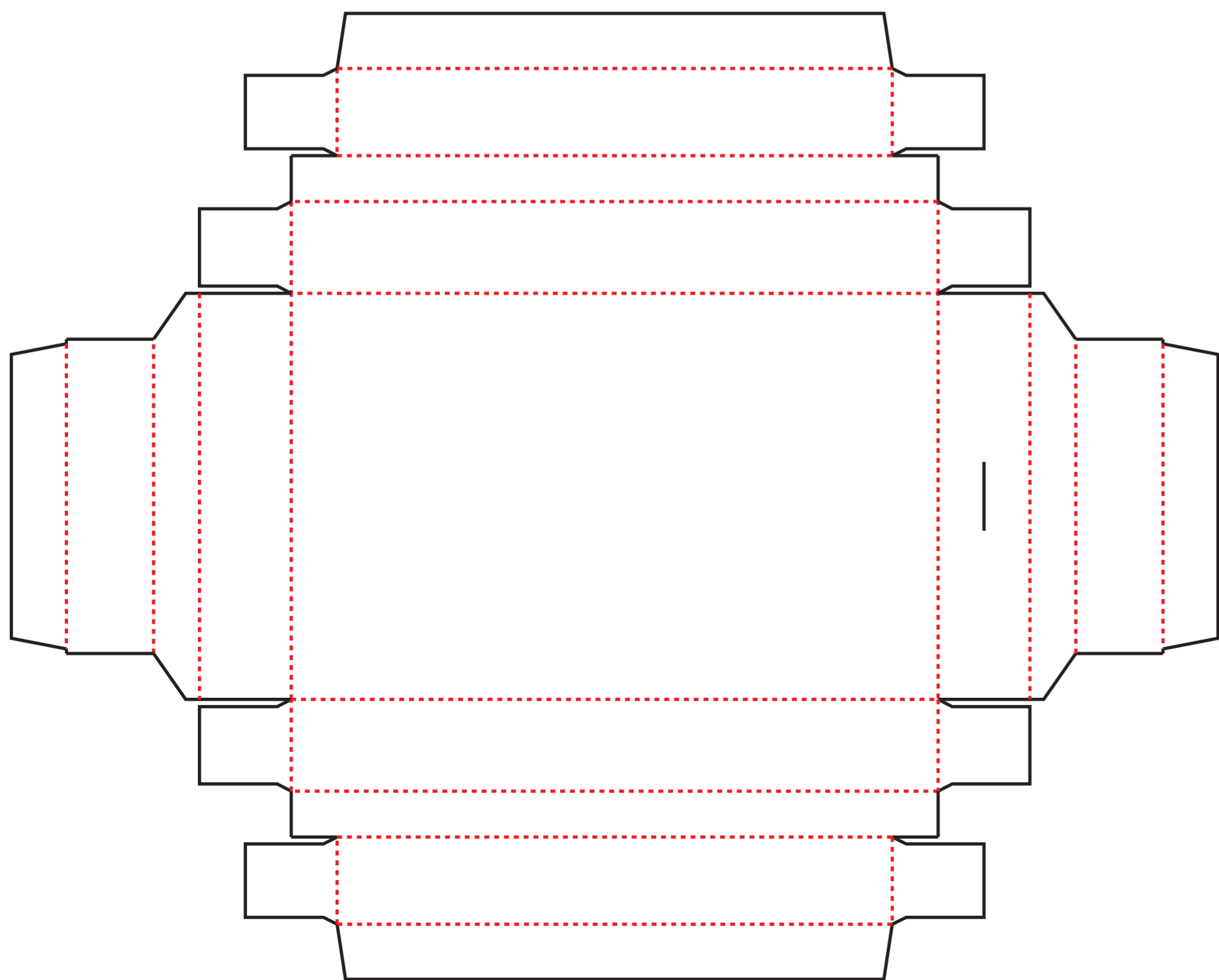
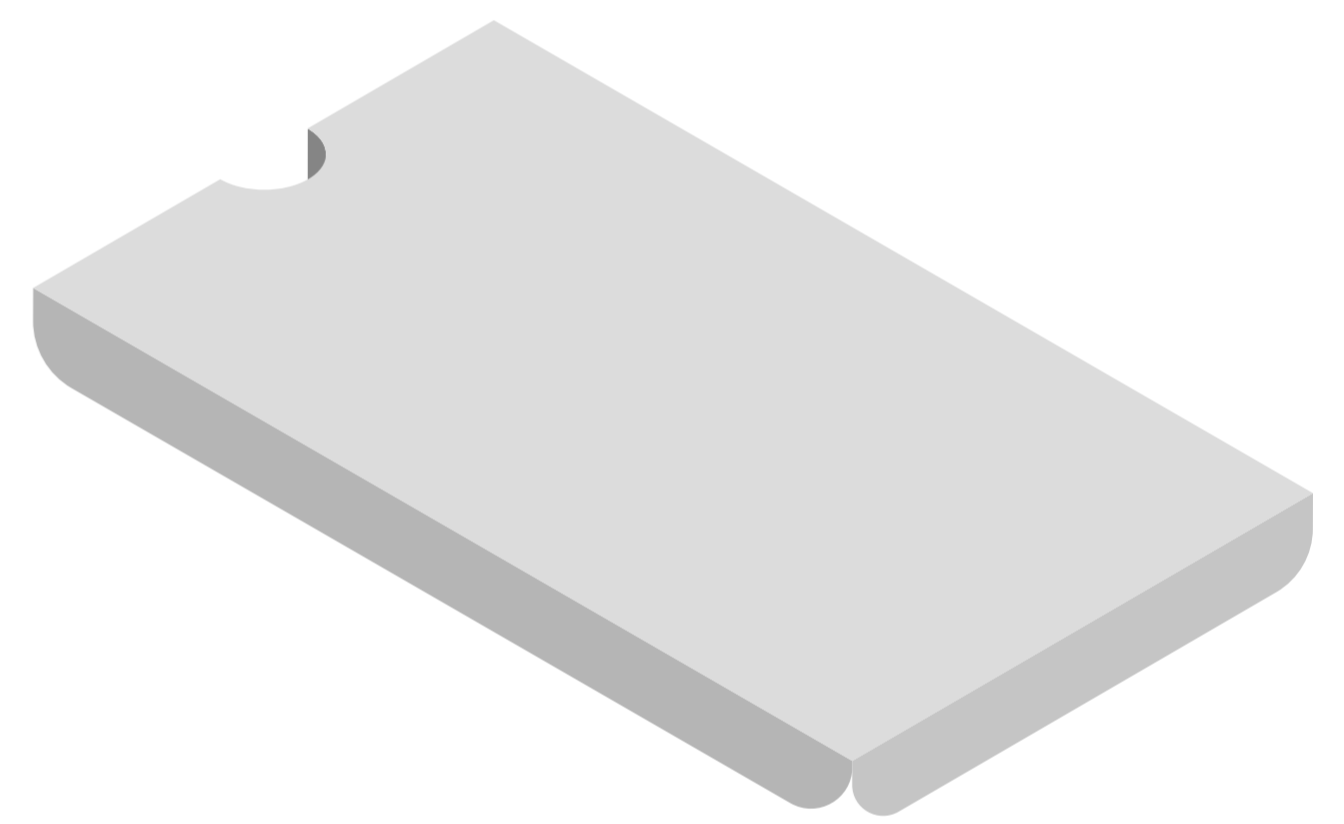
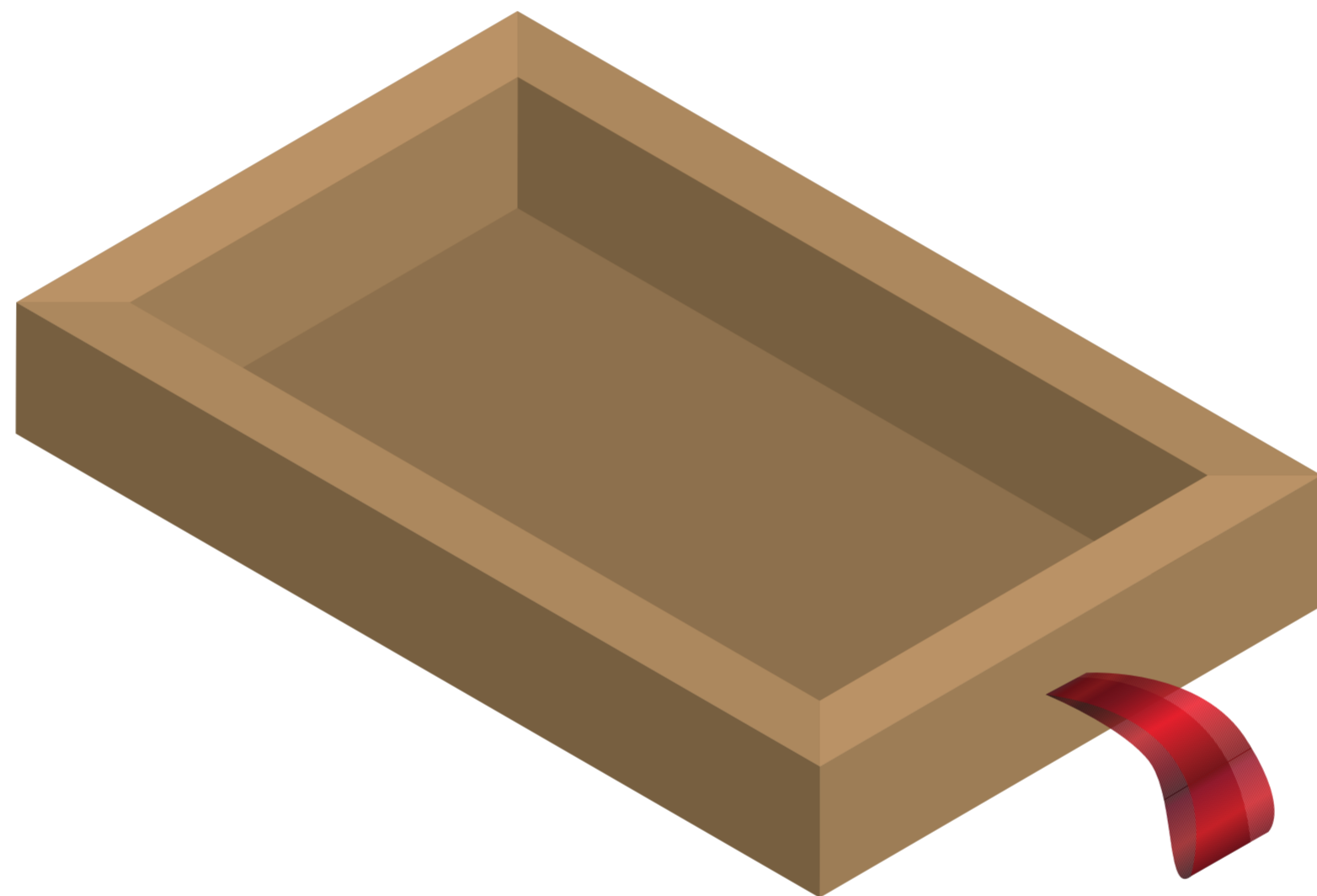

Hard Paper 200-300 gsm

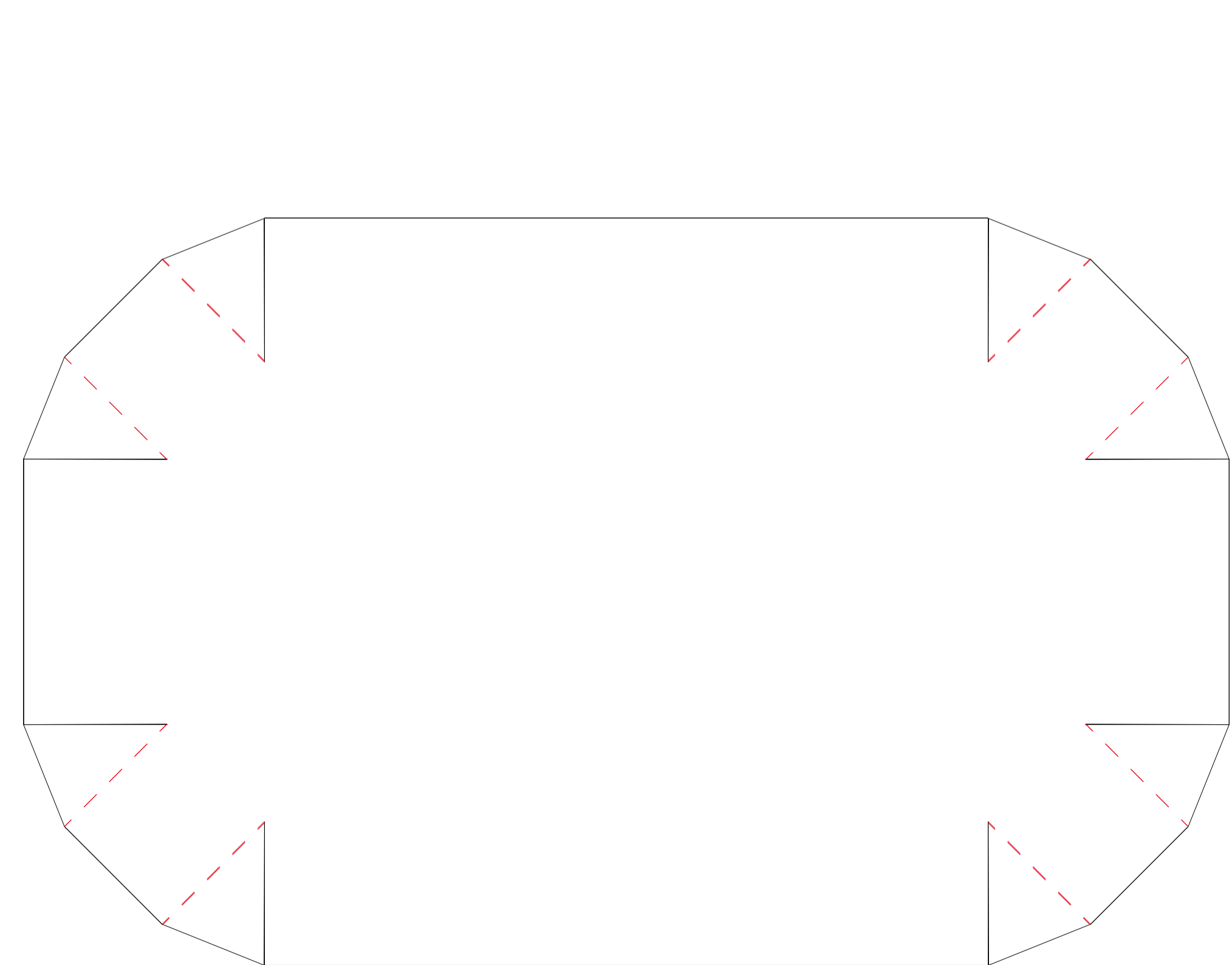
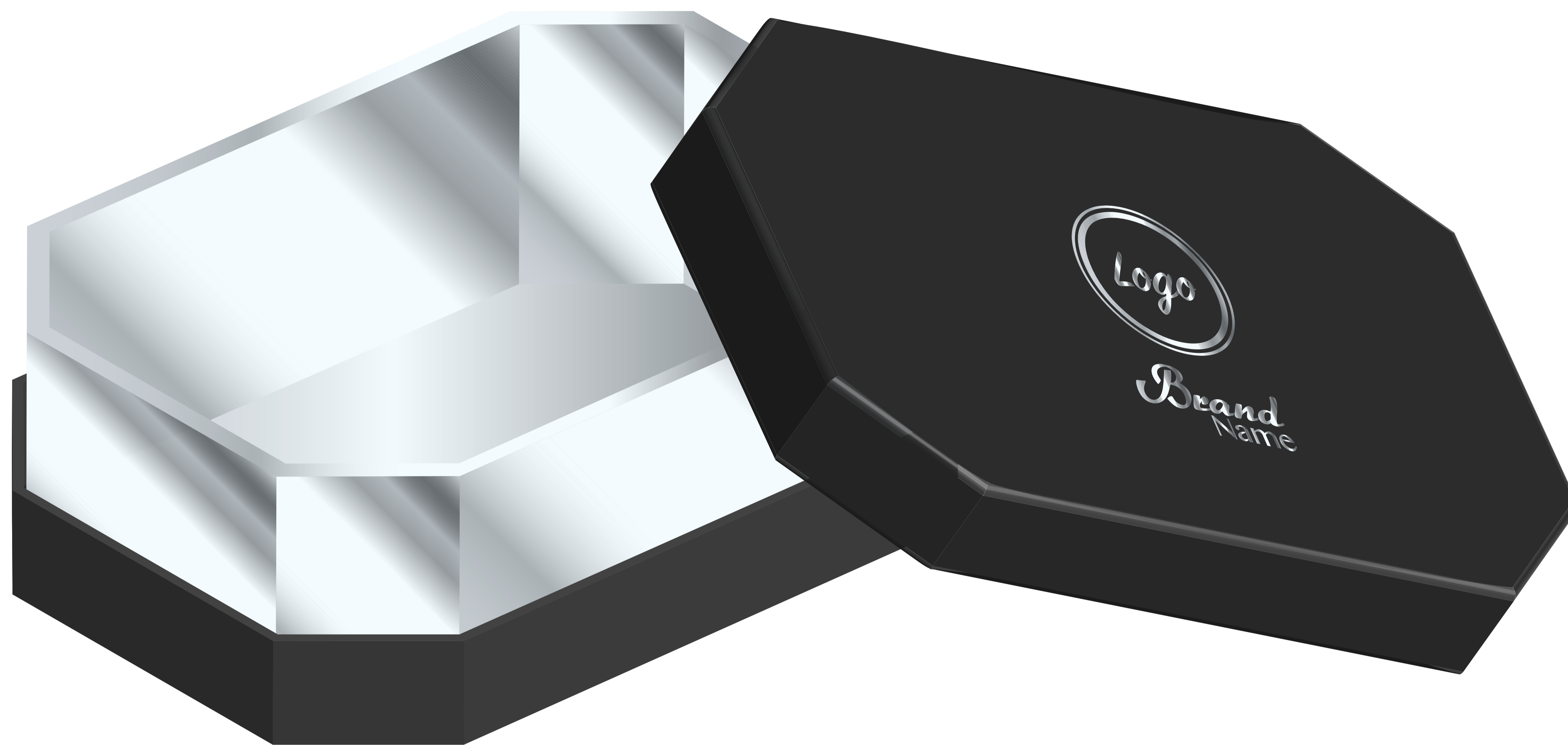
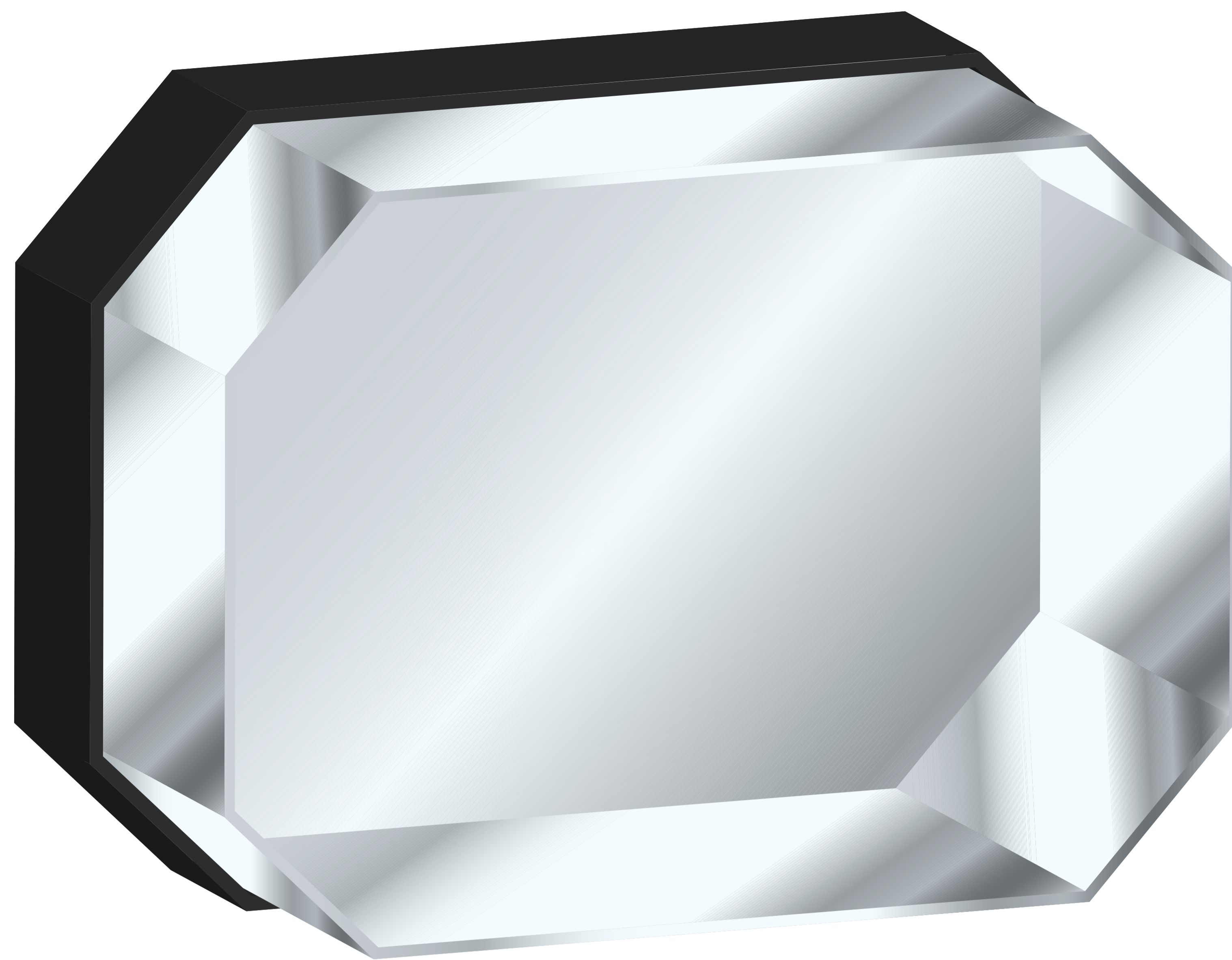

Wrapping Paper
Top And Bottom Box

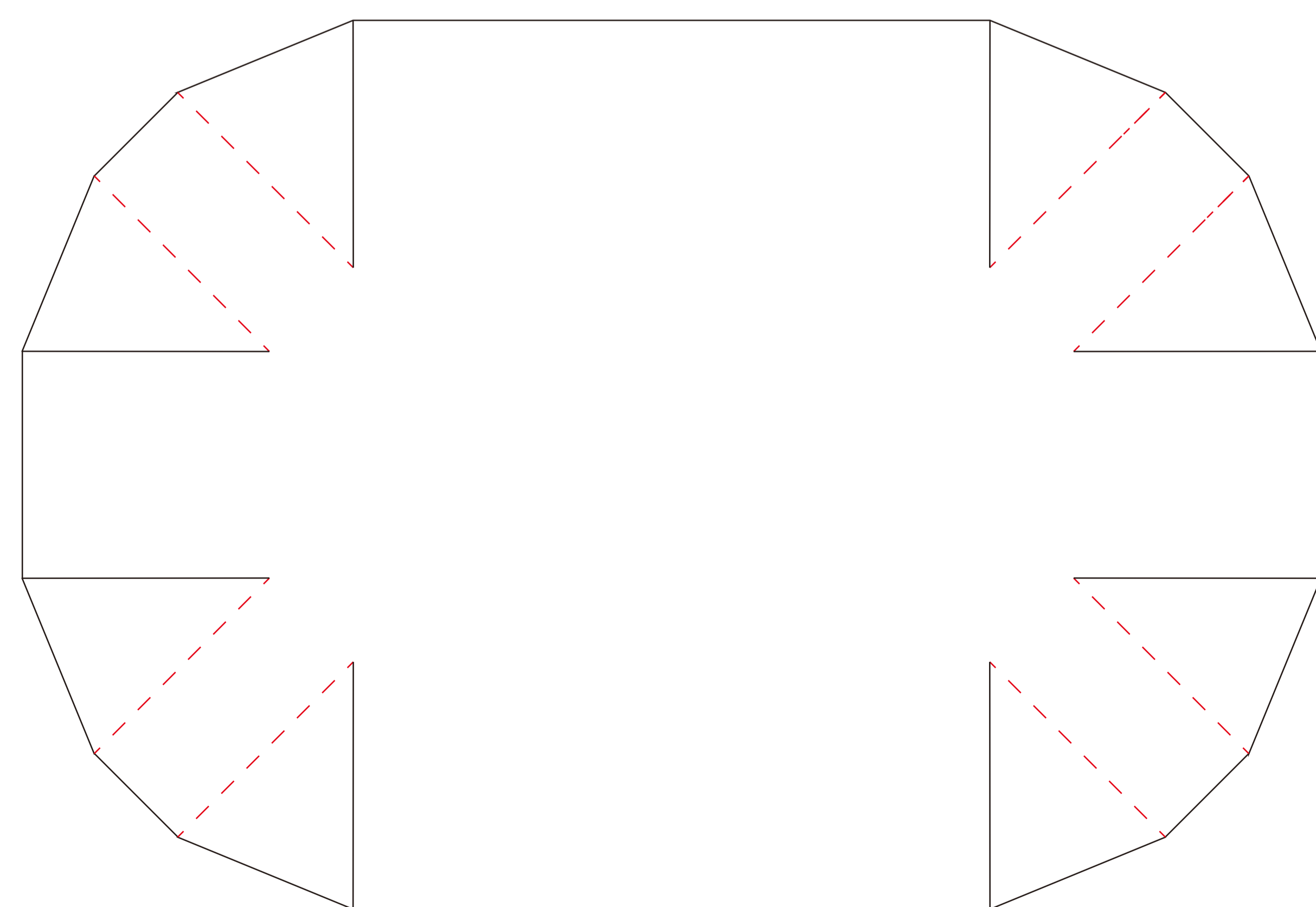

Wrapping Paper
Inside Box

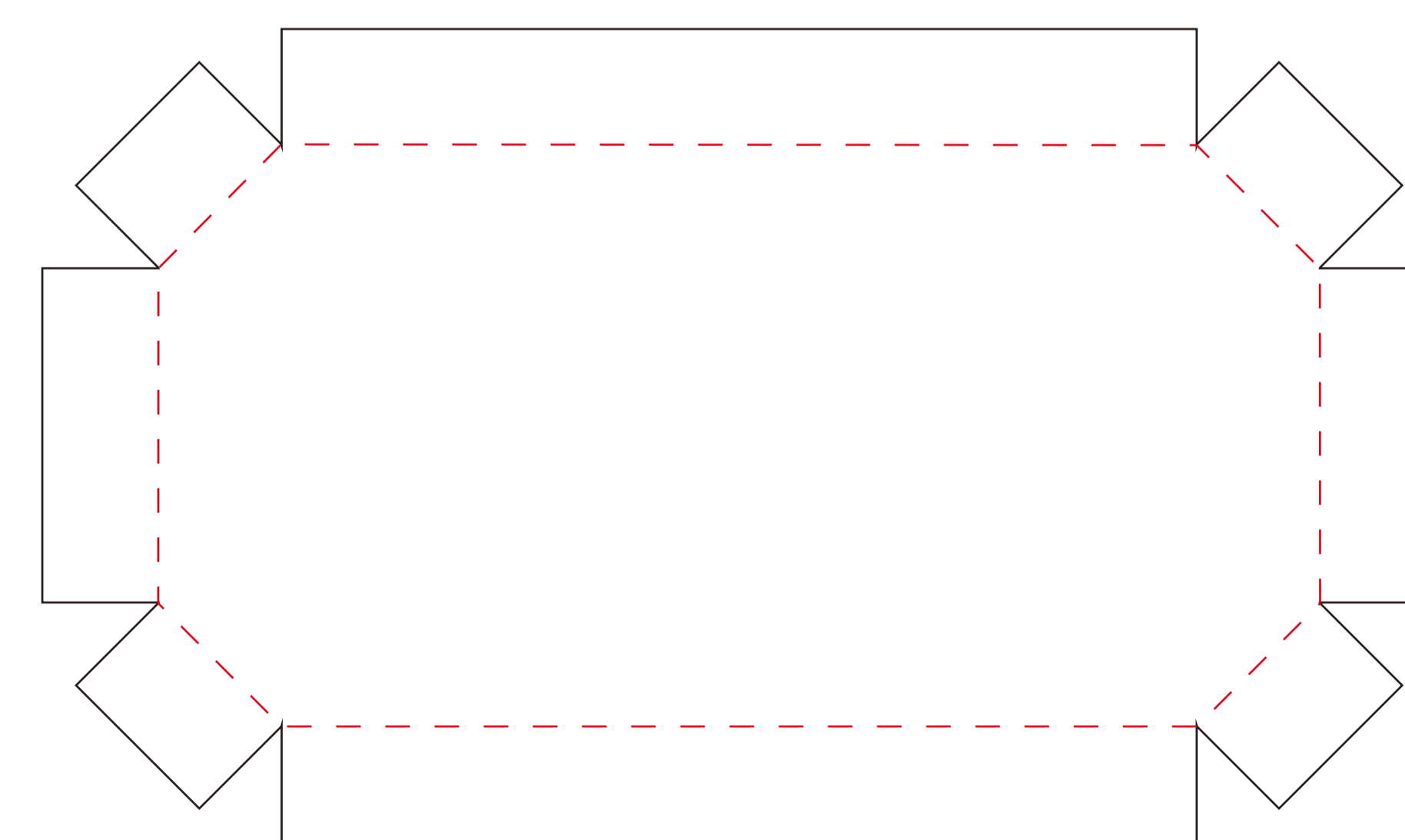

Hard Board Paper
Thick 1.6 mm
Top And Bottom Box

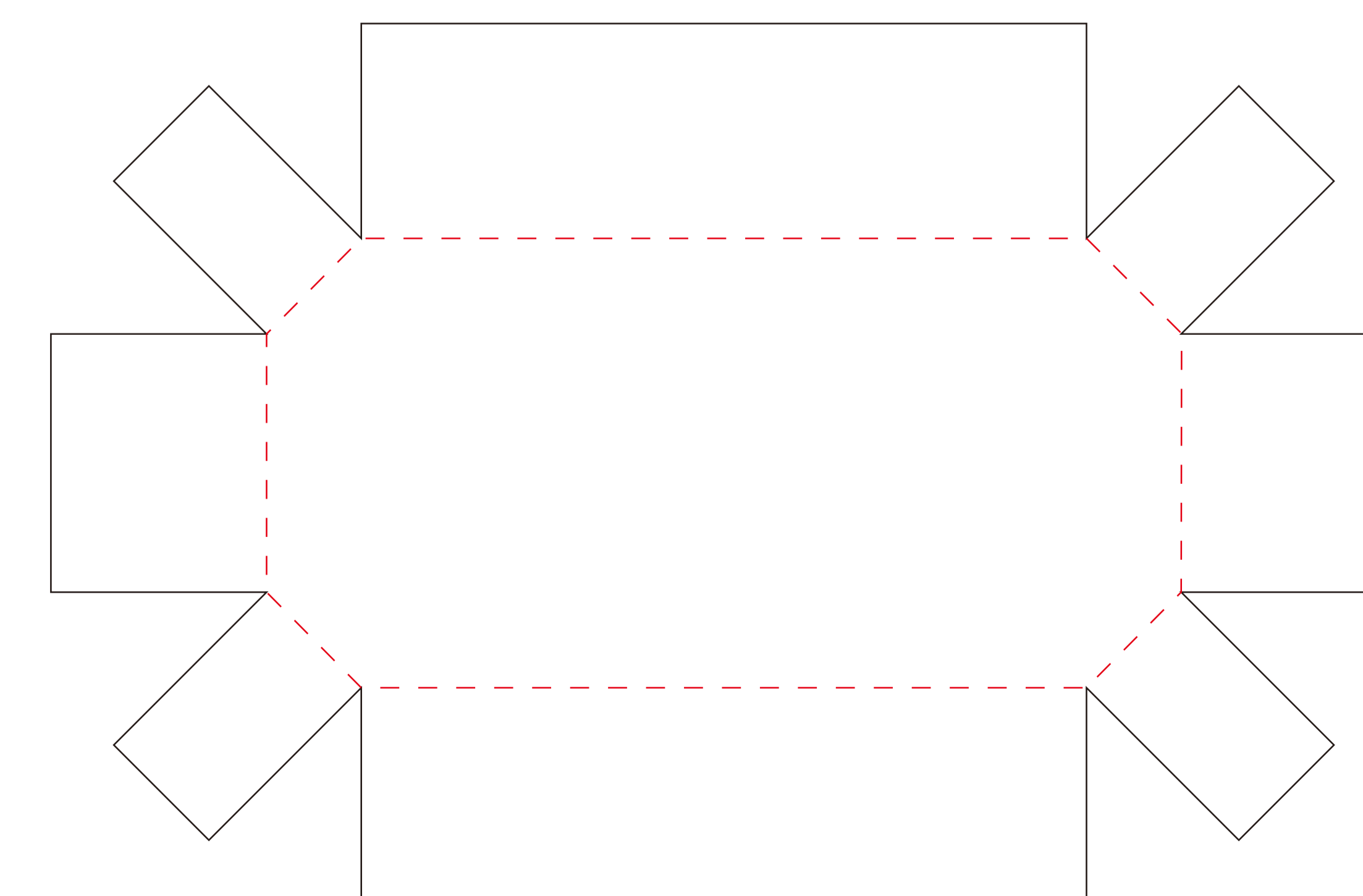

Hard Board Paper
Thick 1.6 mm
Inside Box

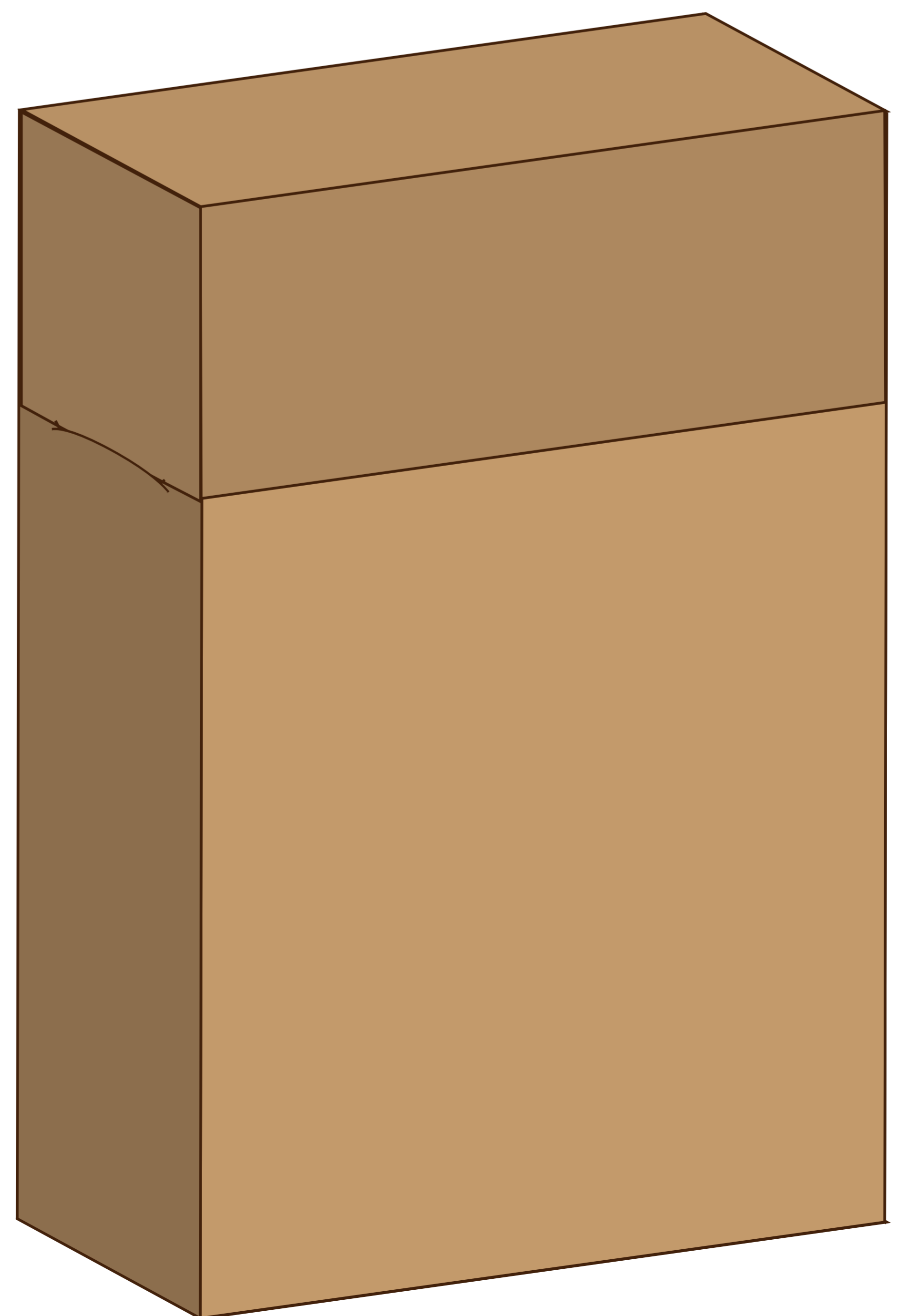
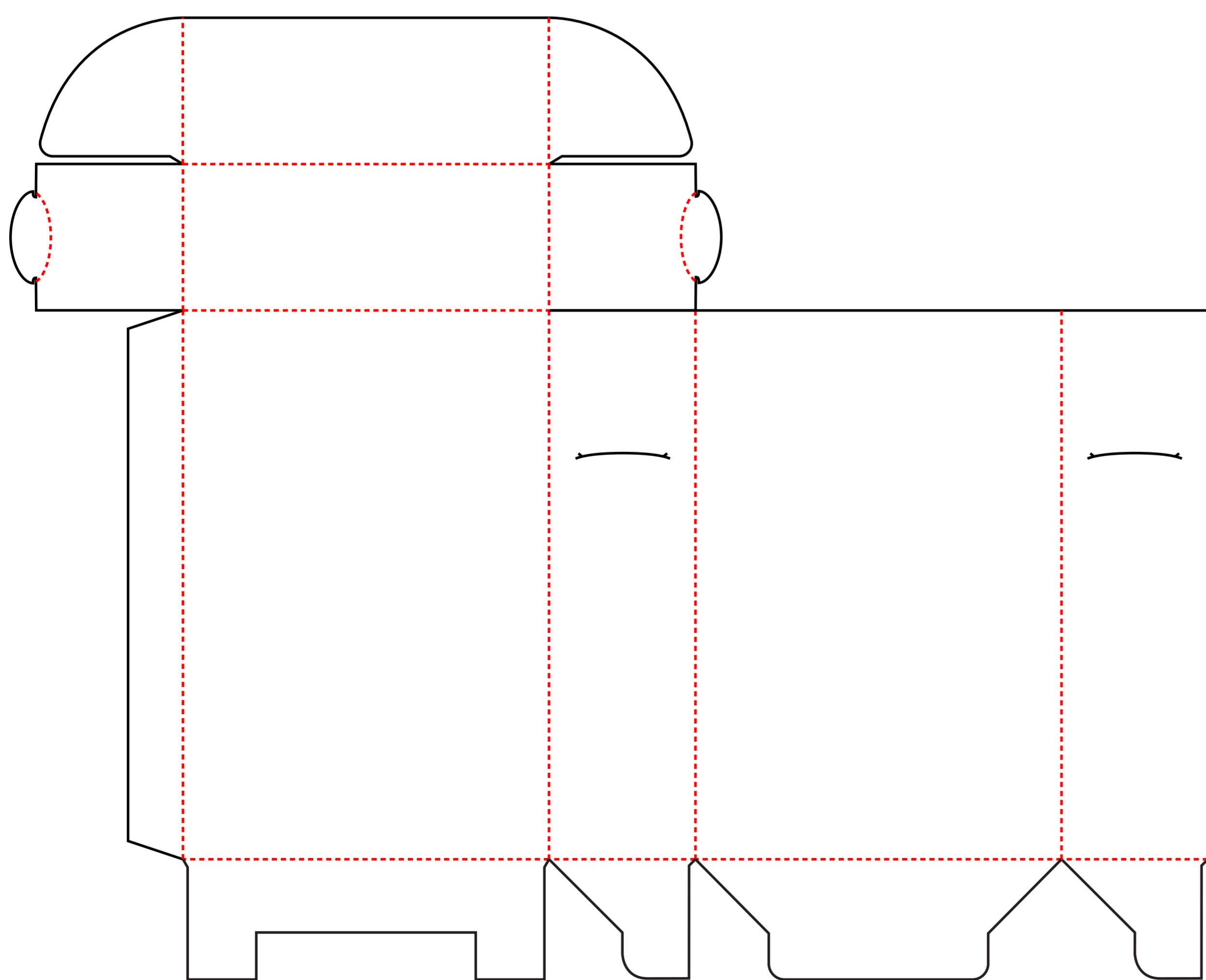
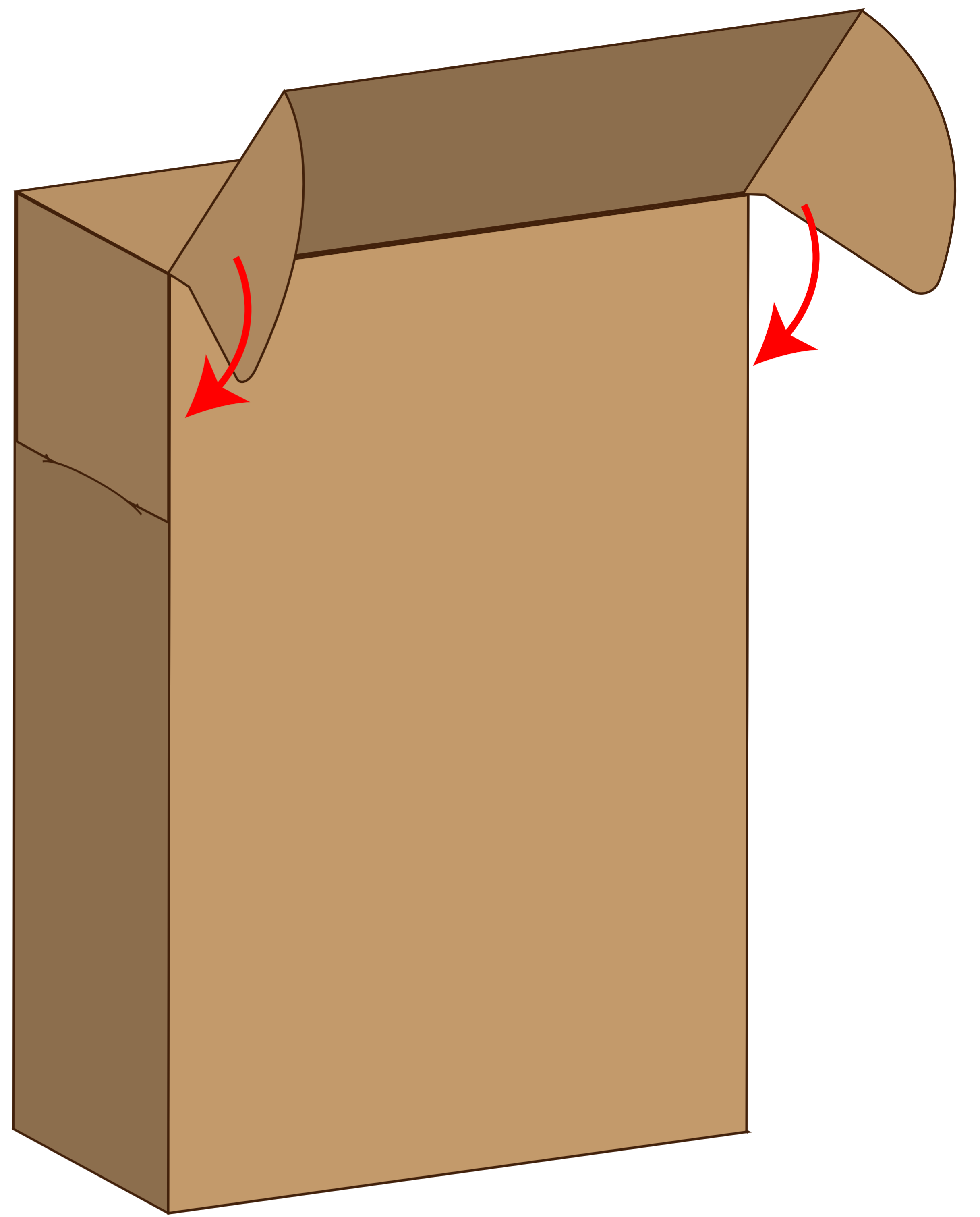
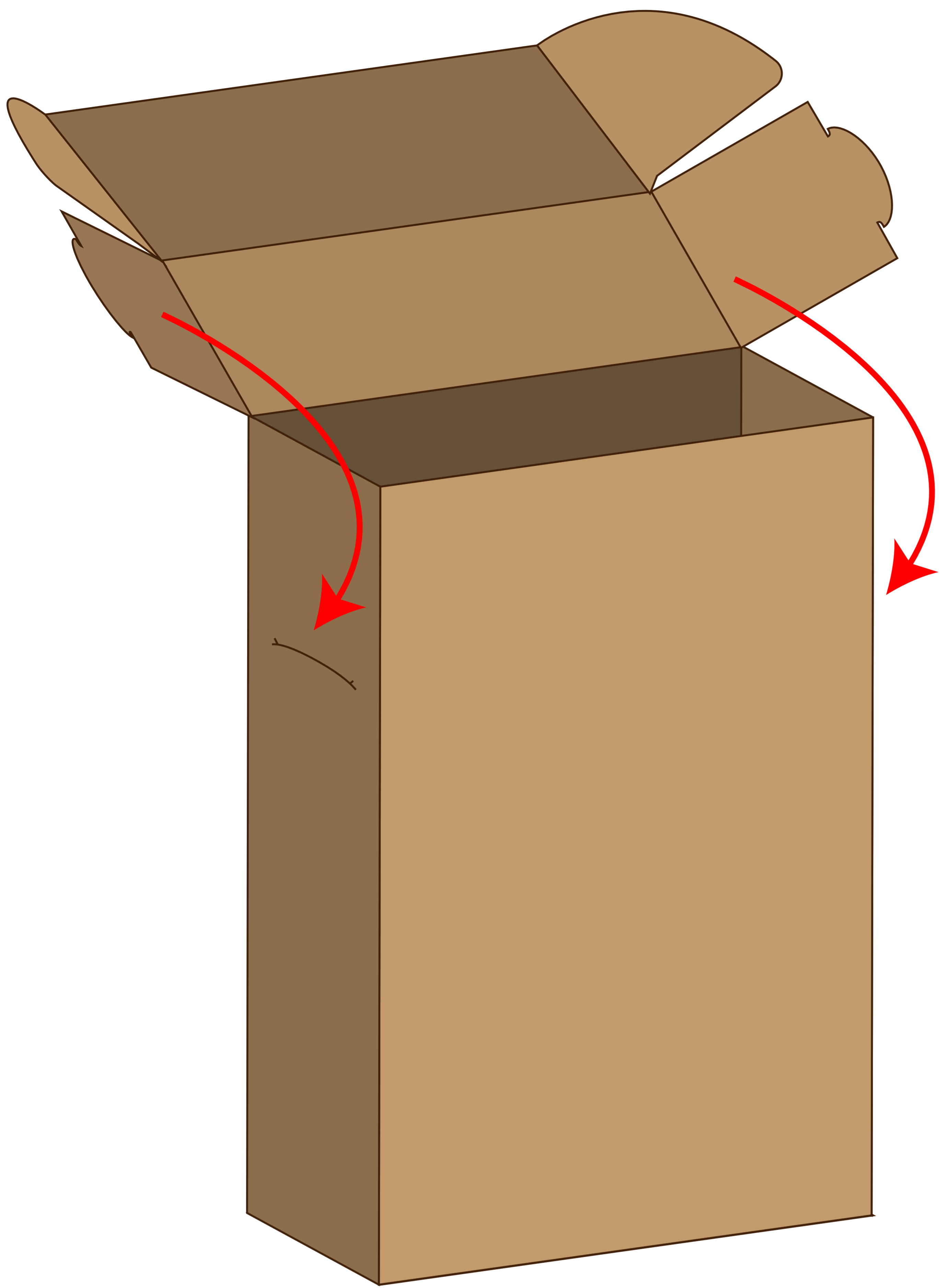

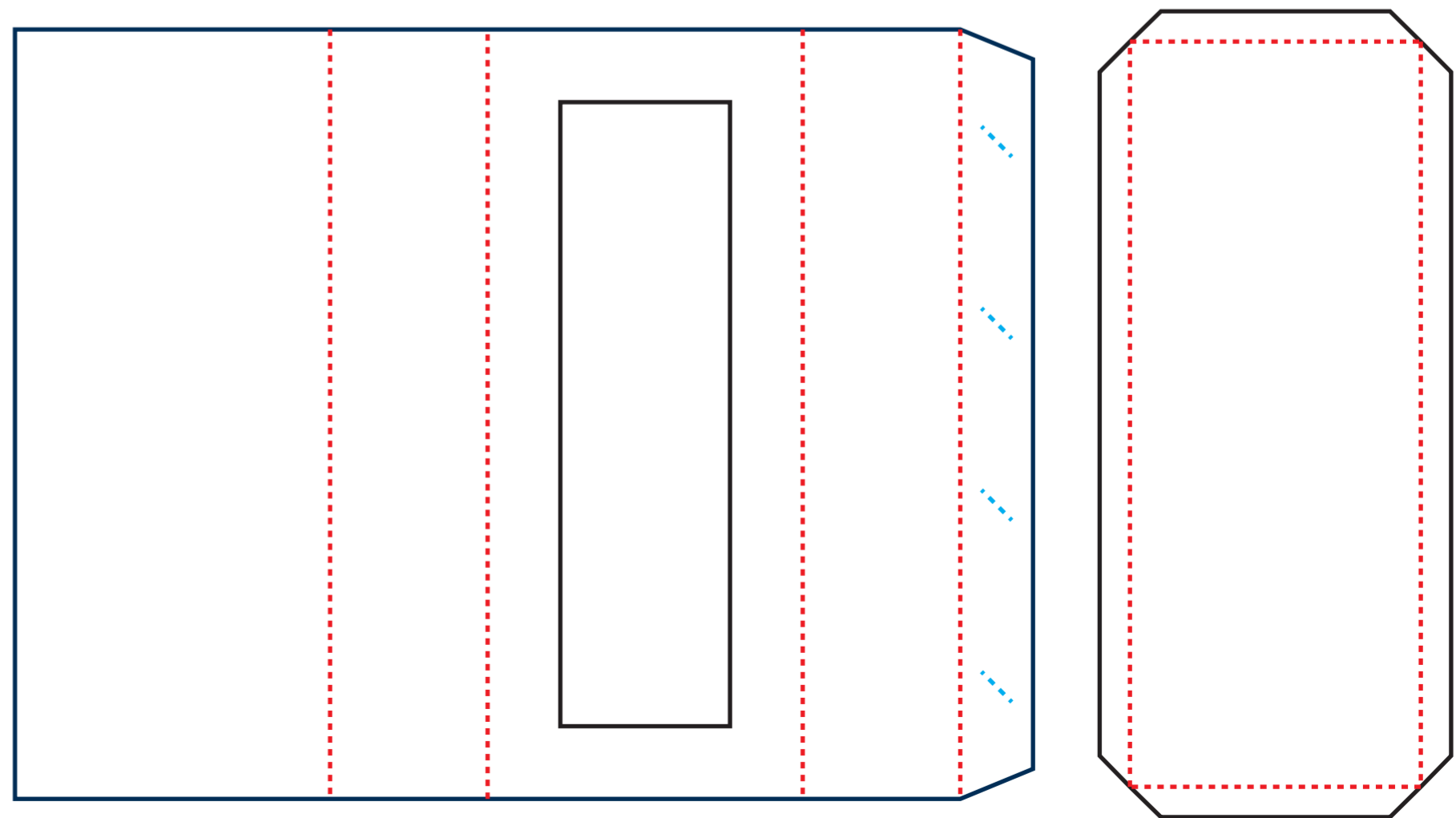
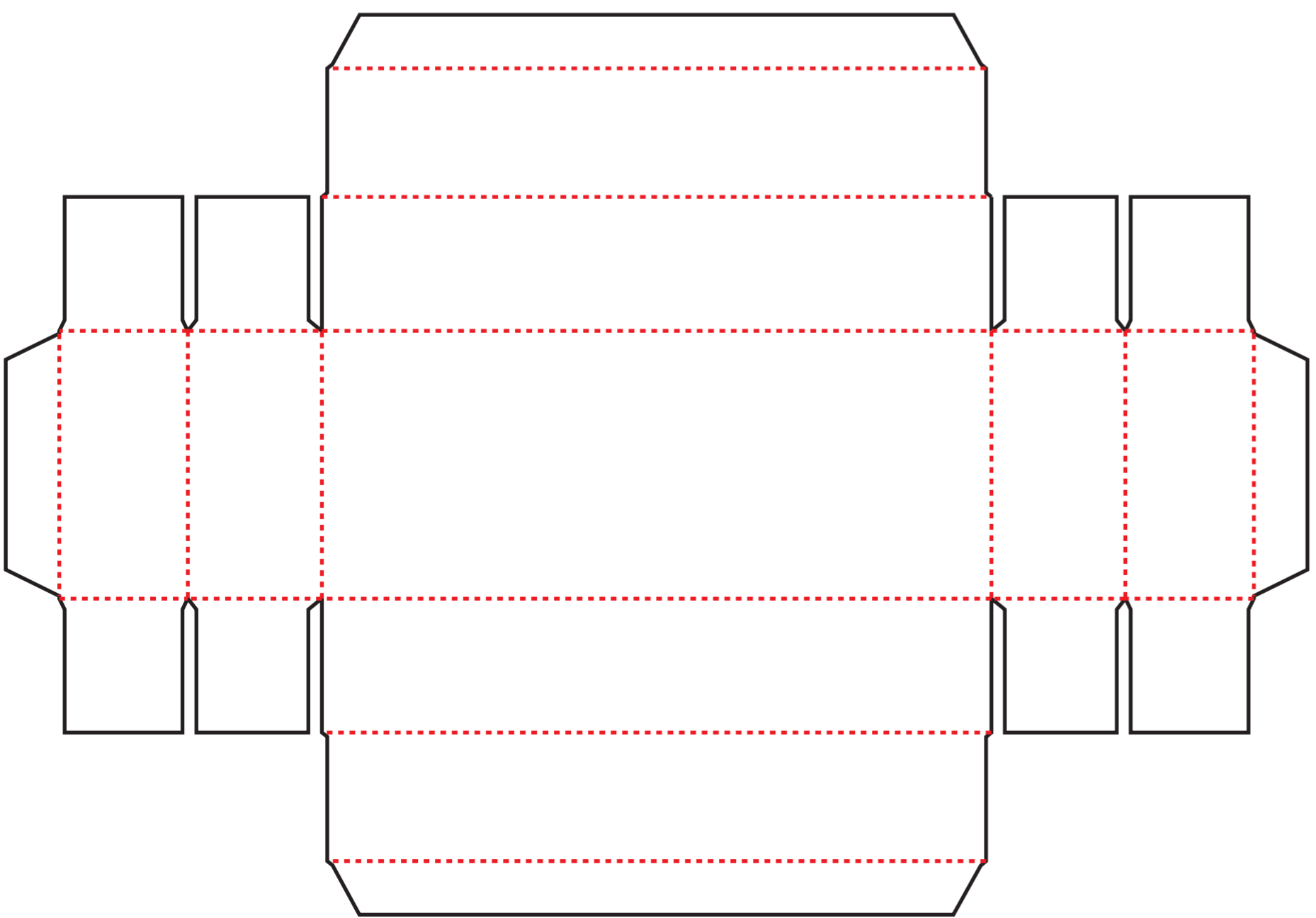
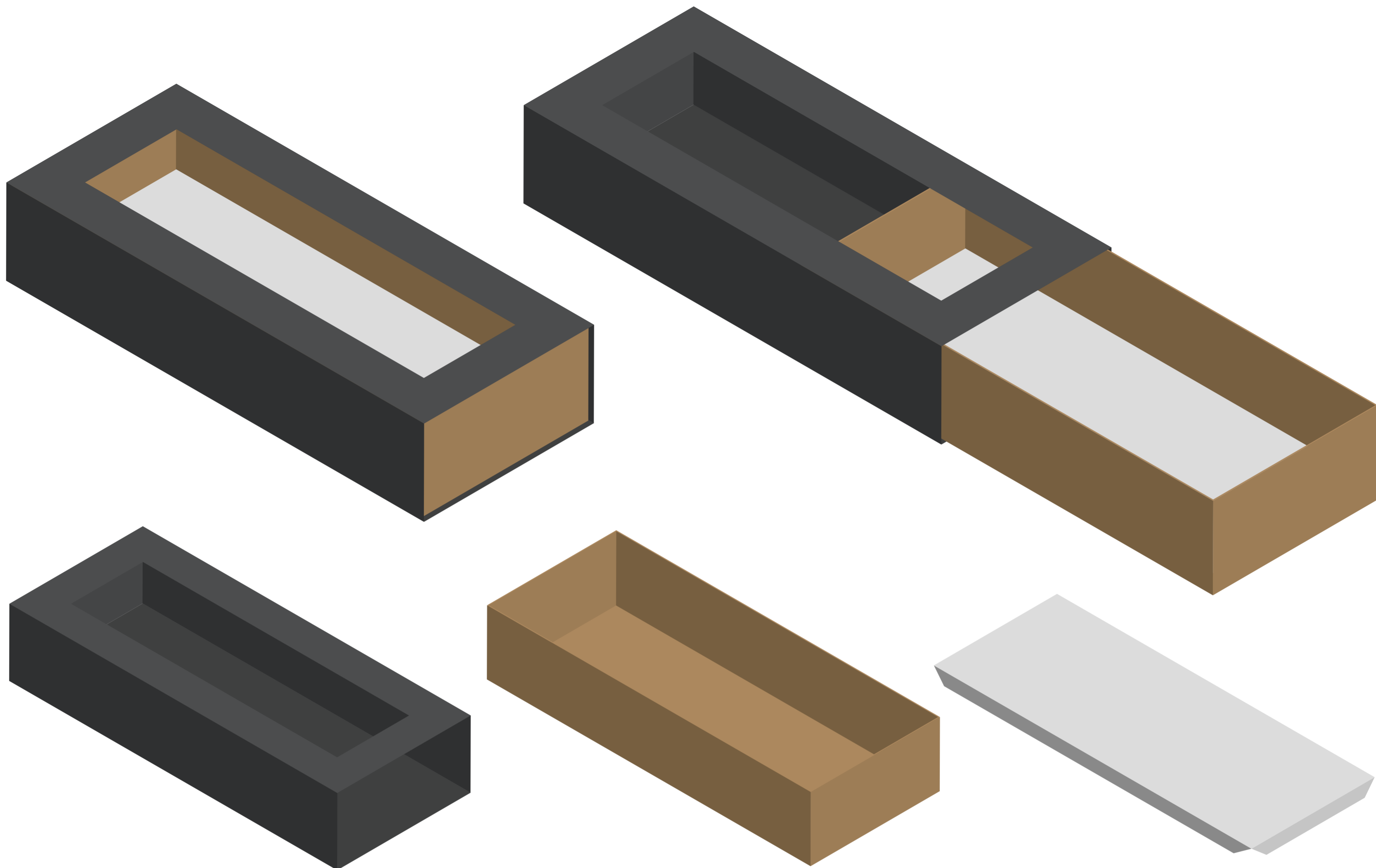

Hard Paper 250-300 gsm

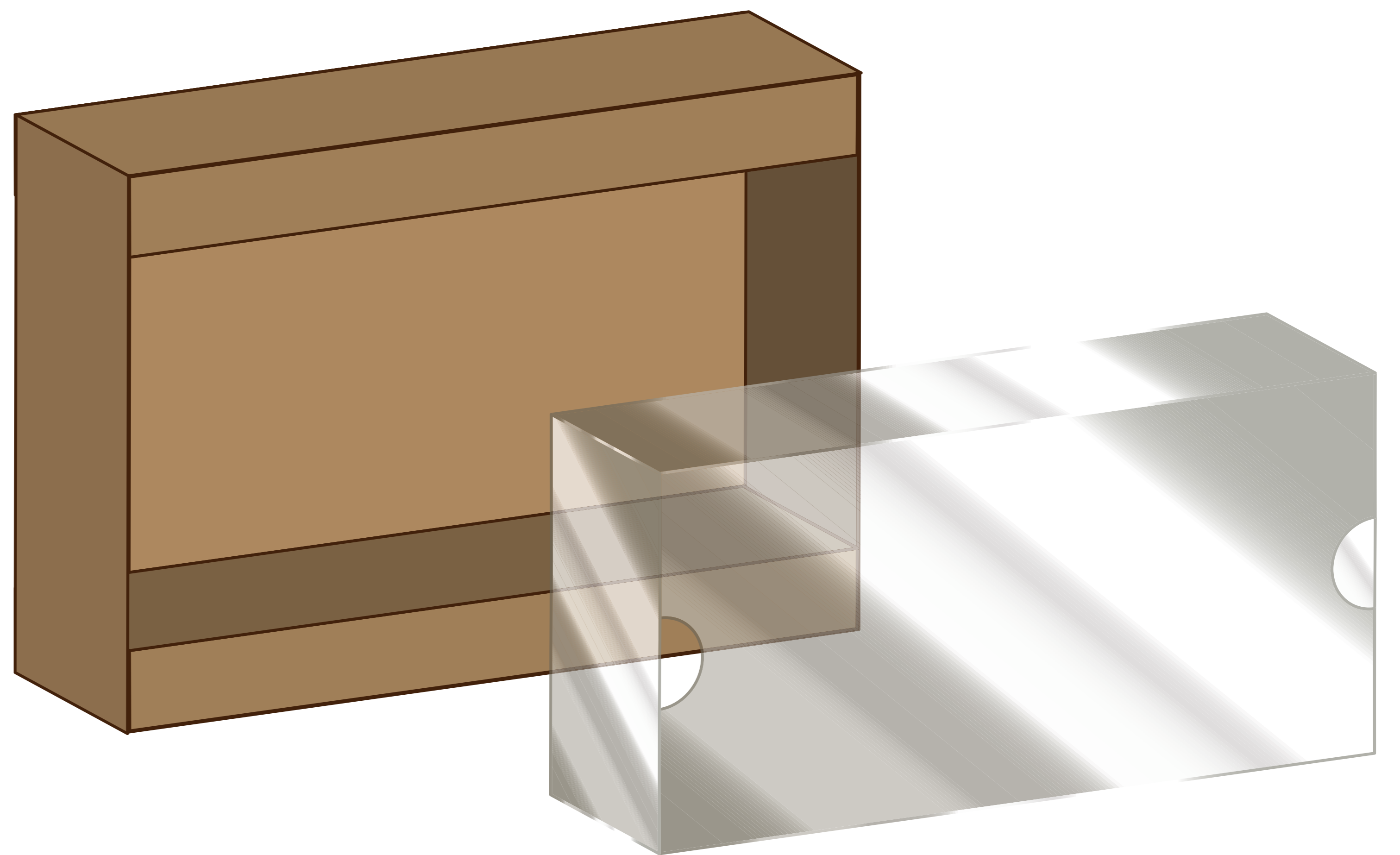
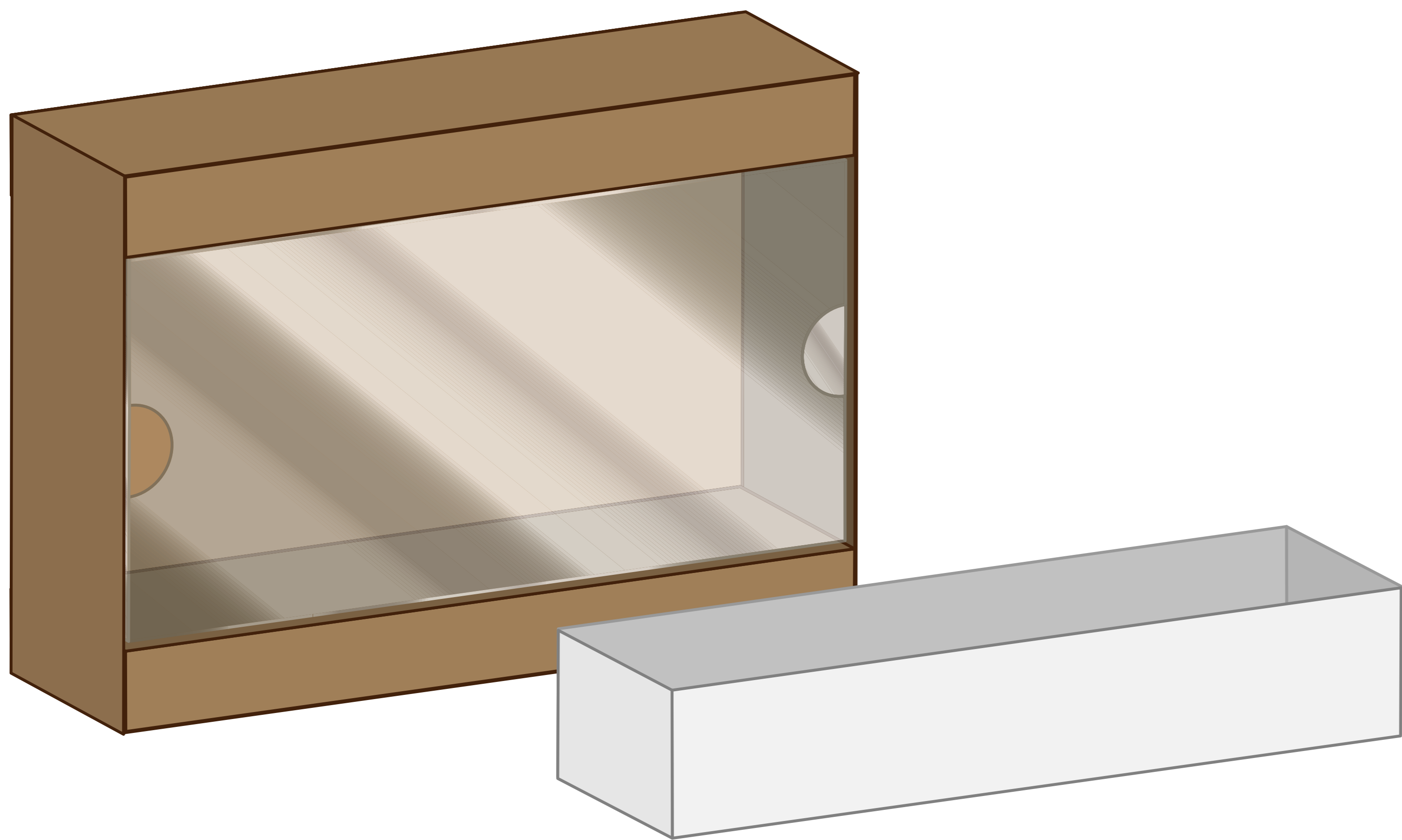
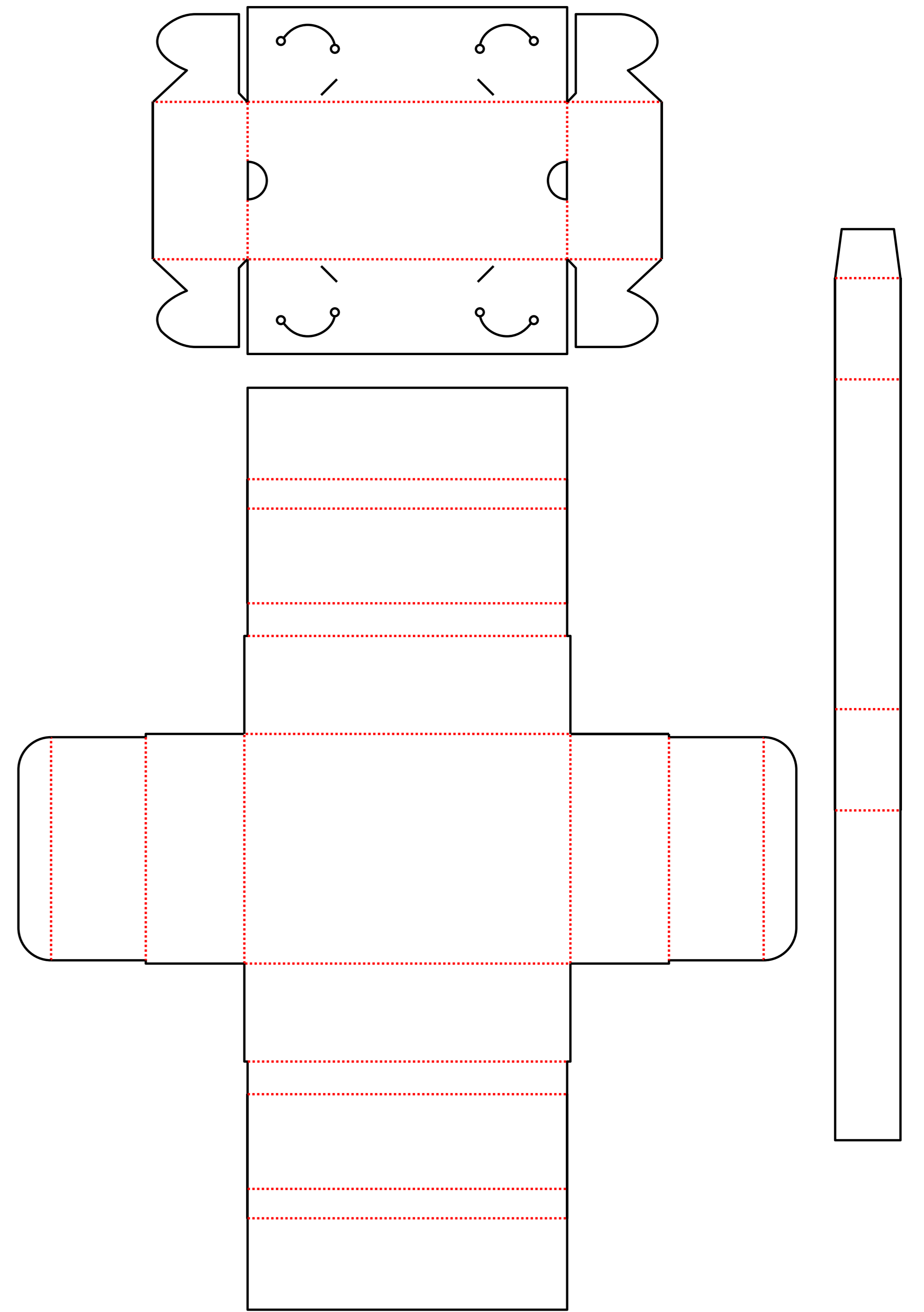
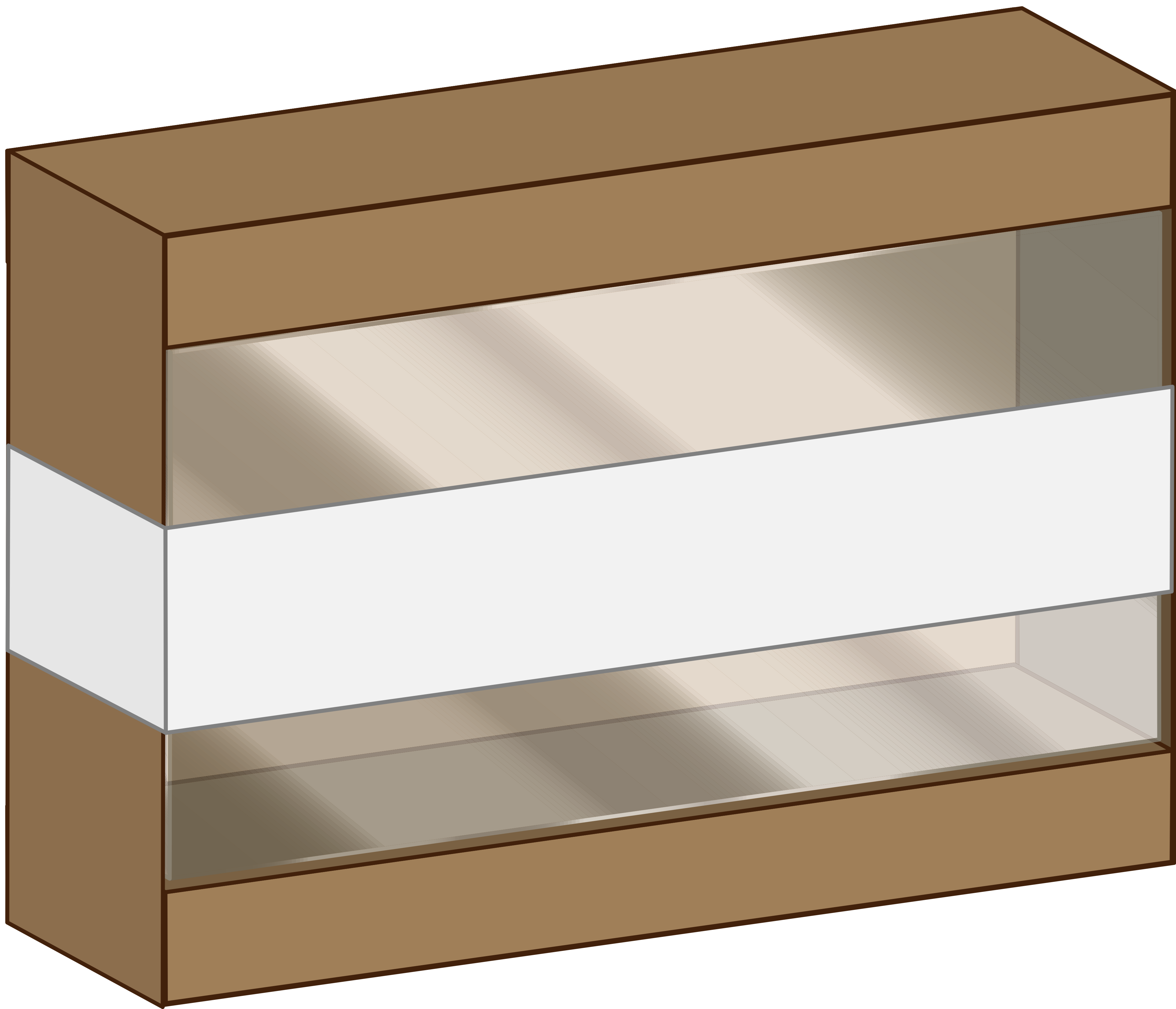

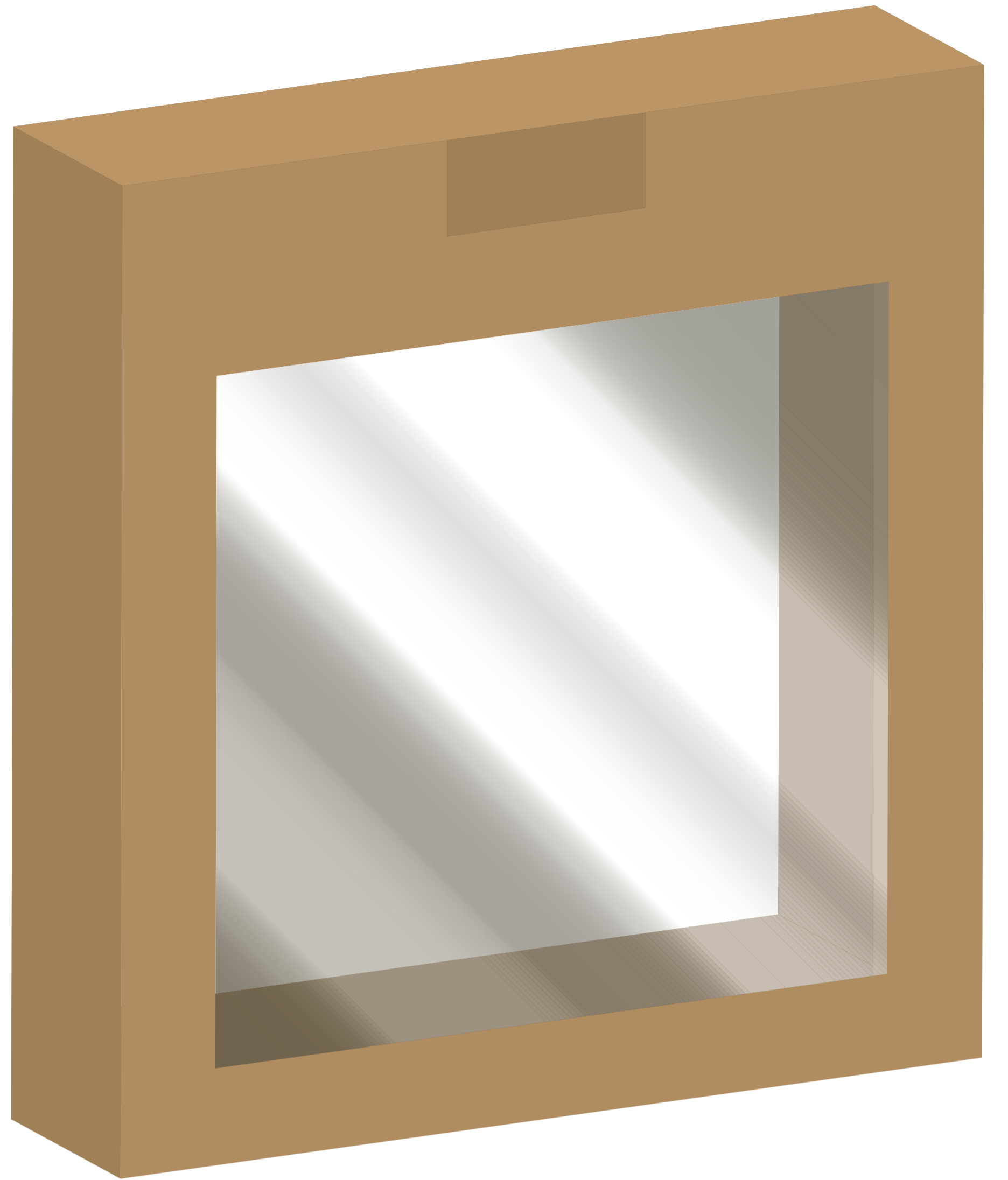

Corrugated Paper : E Flute

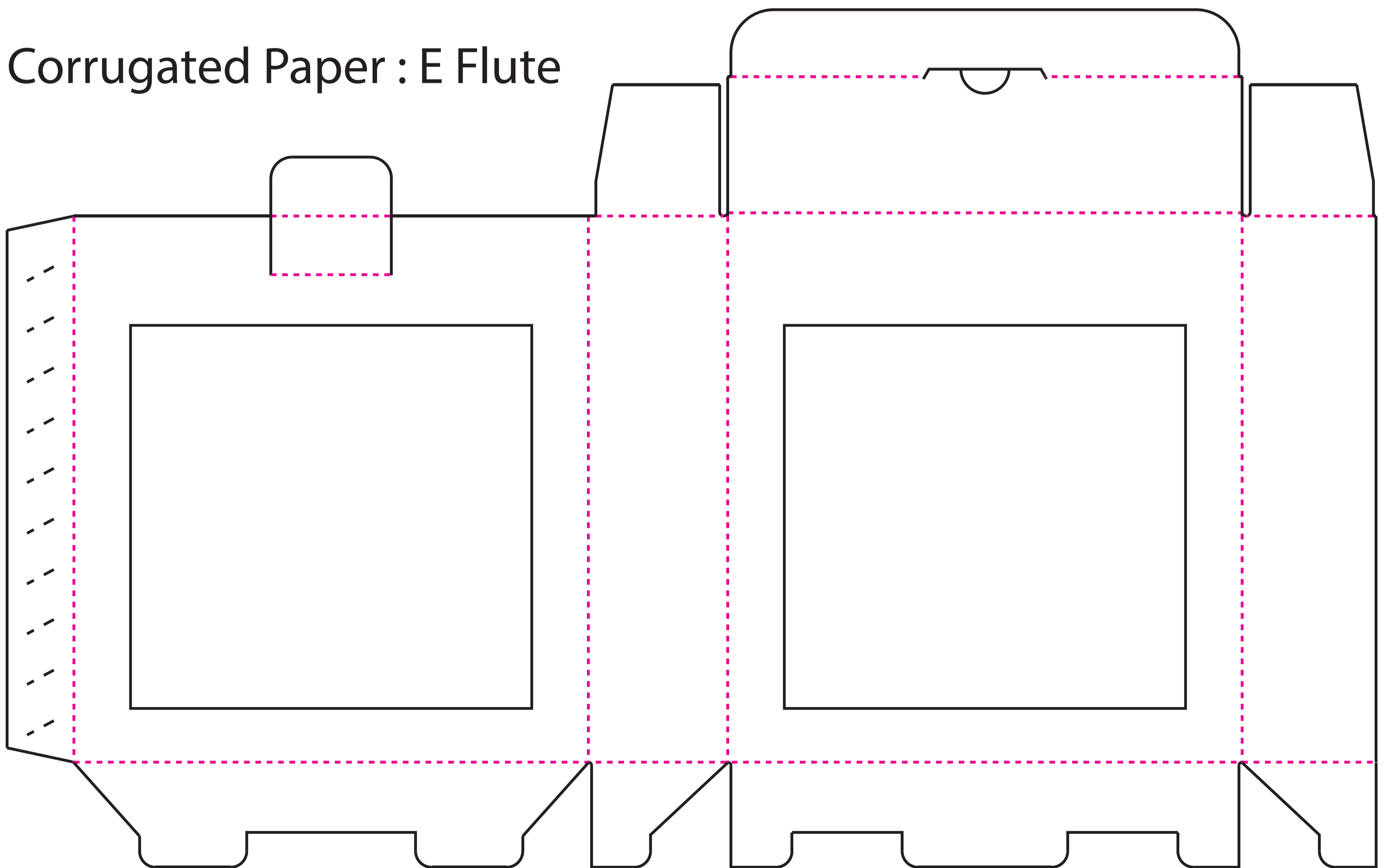

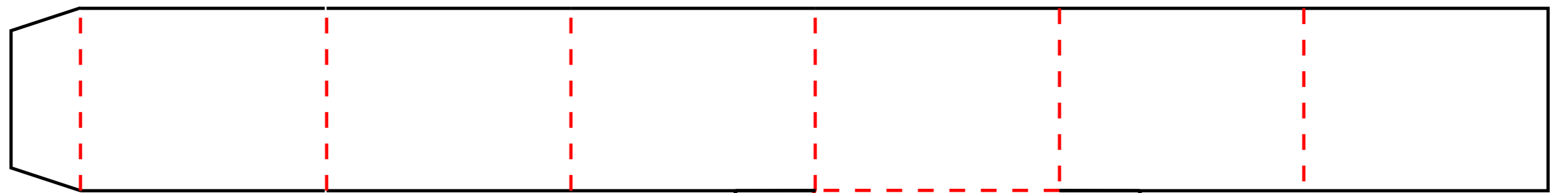
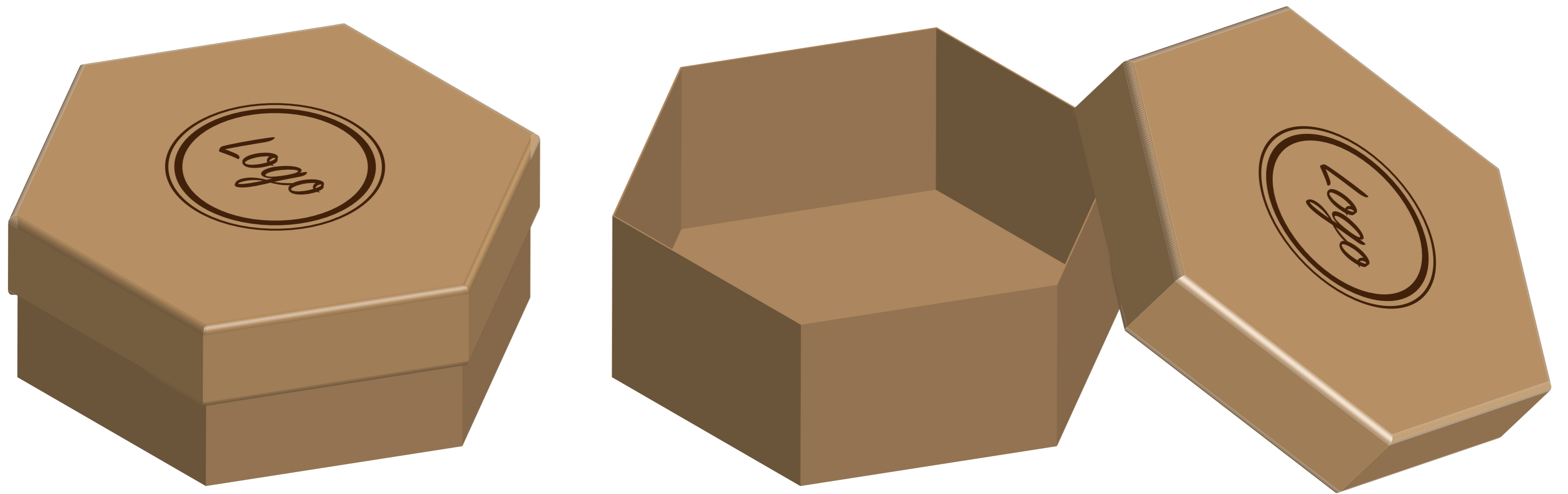

Hard Paper
200-350 gsm.
Top Box

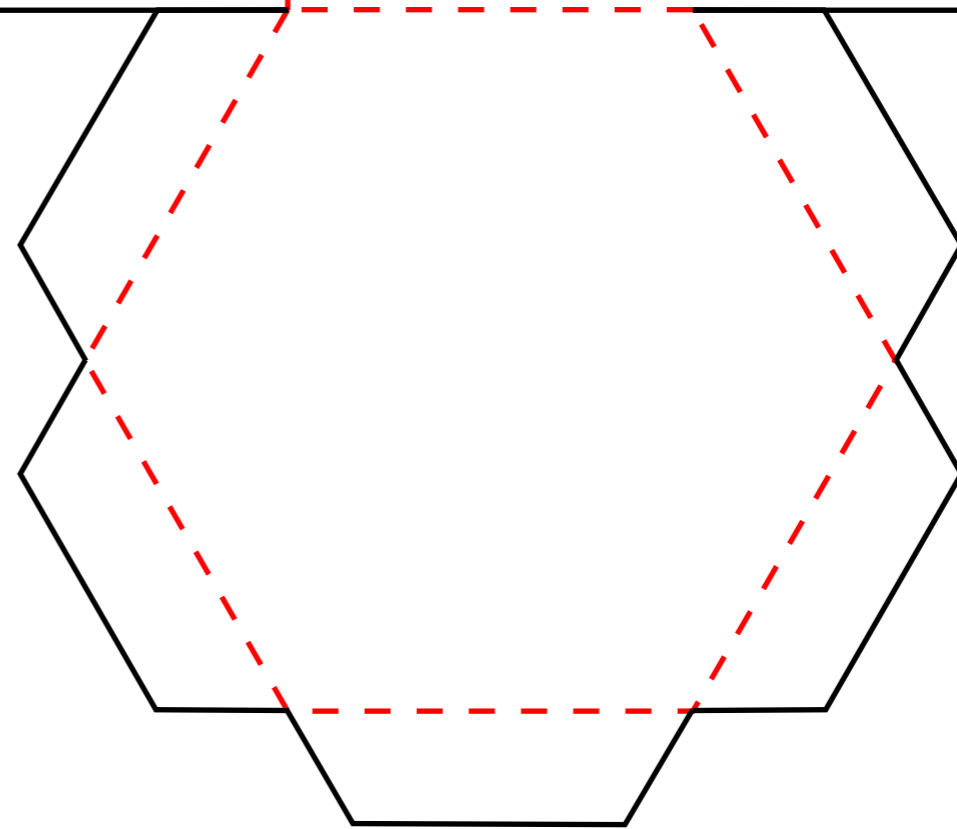
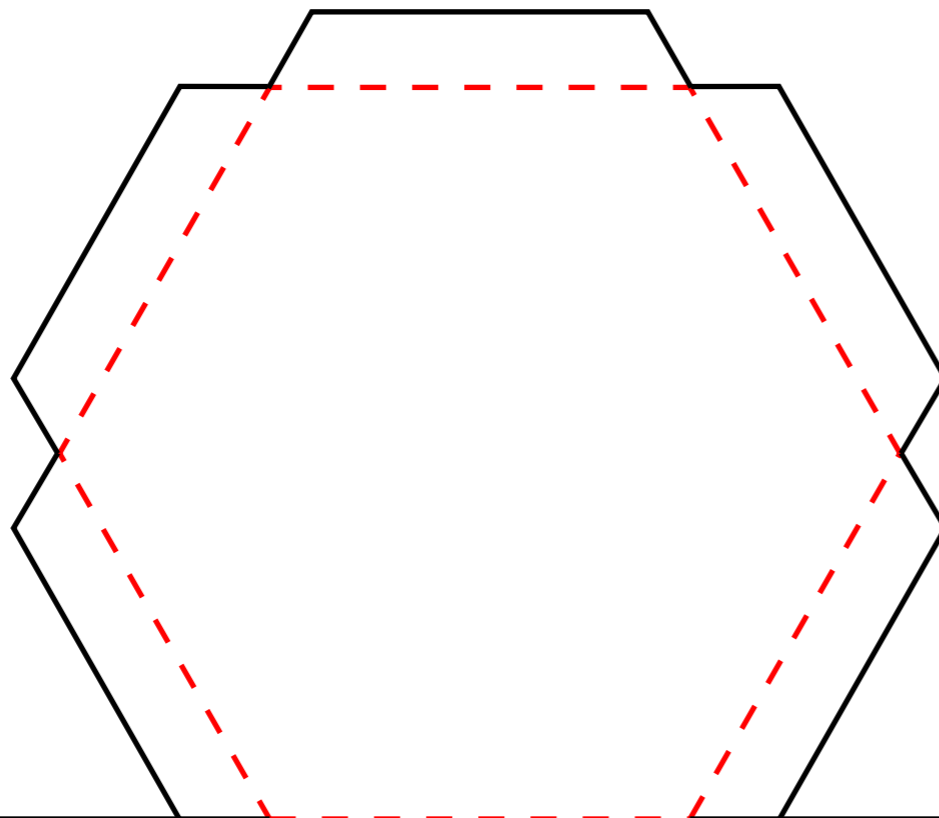

Hard Paper
200-350 gsm.
Bottom Box



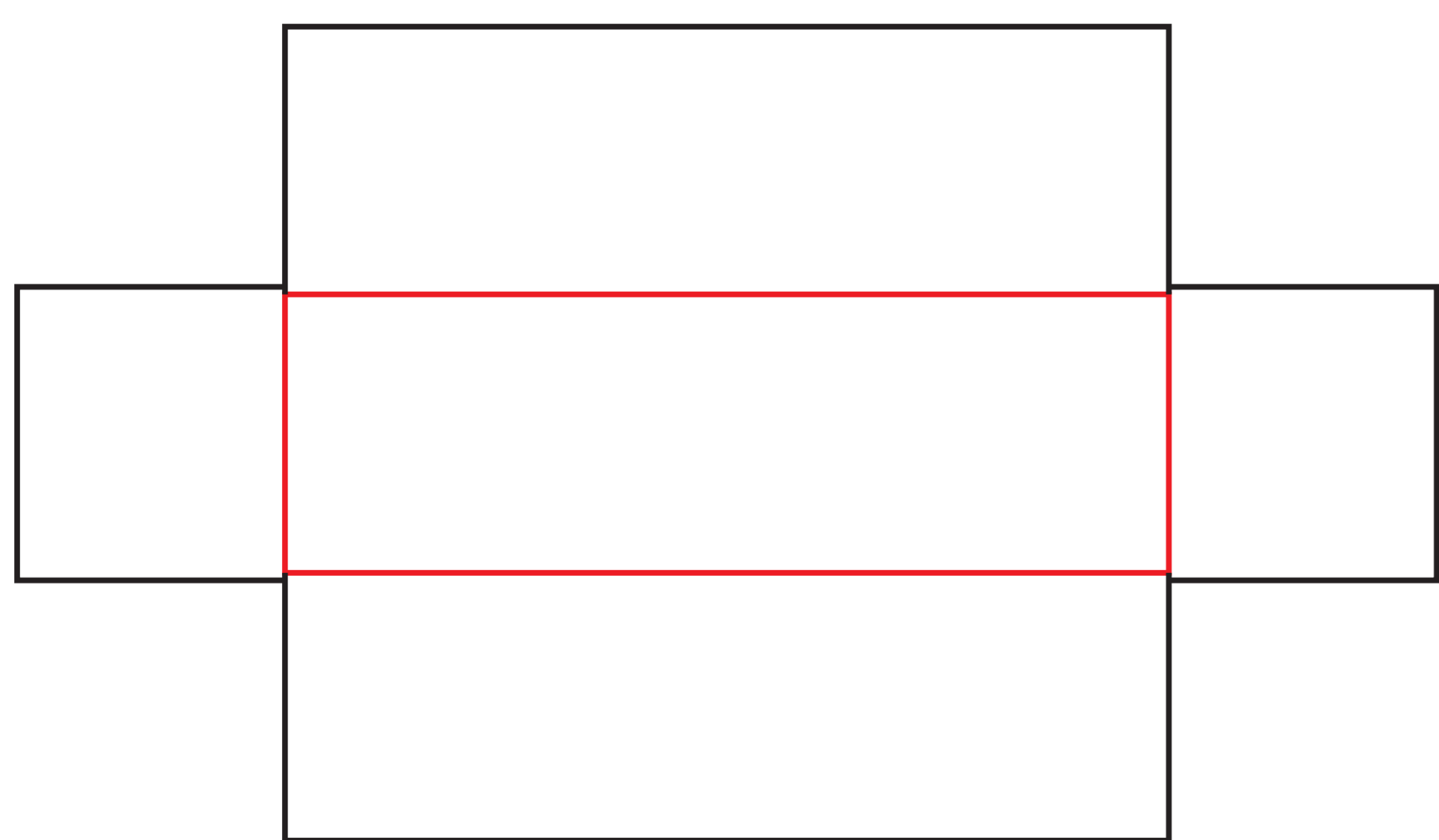
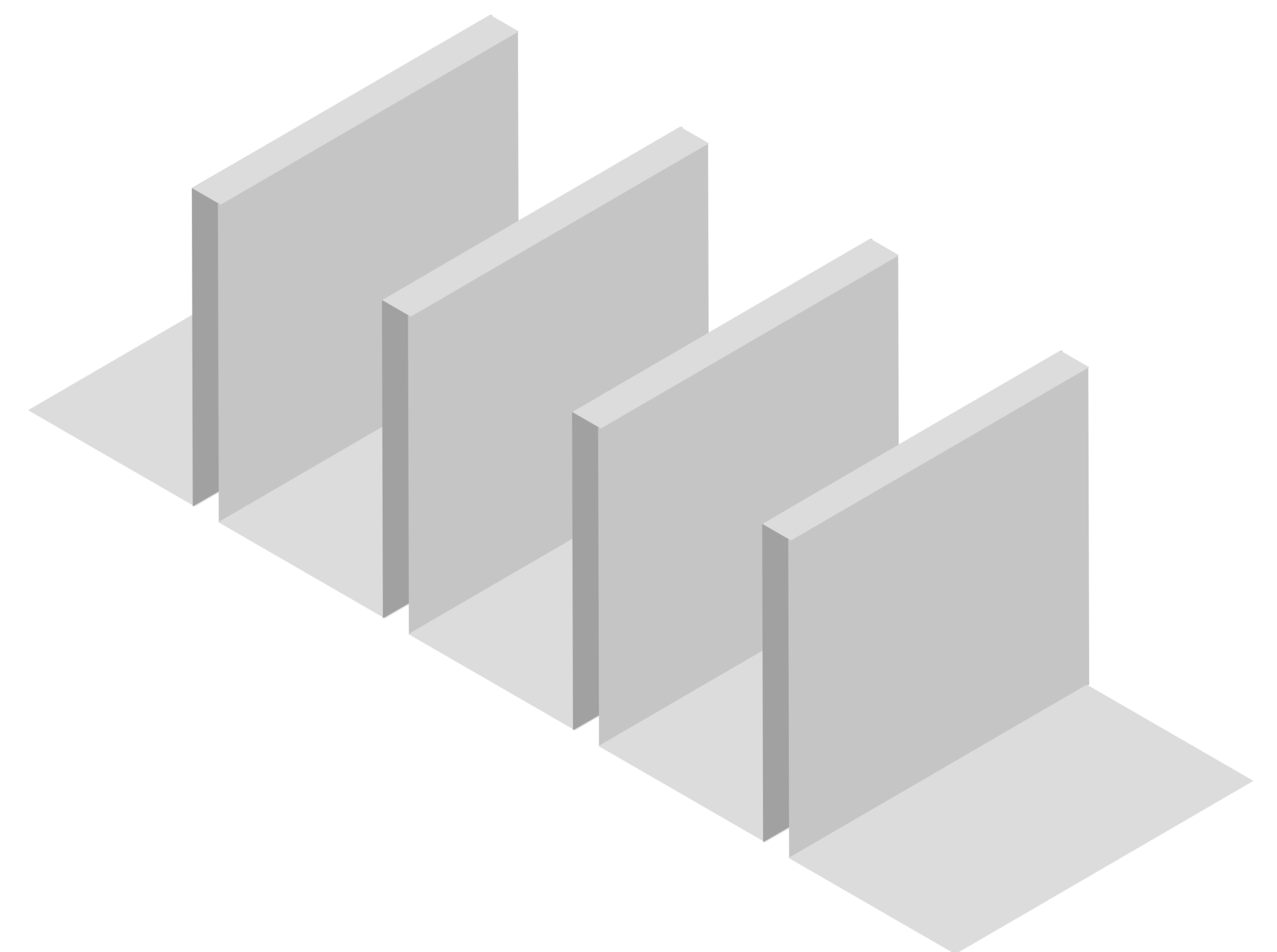
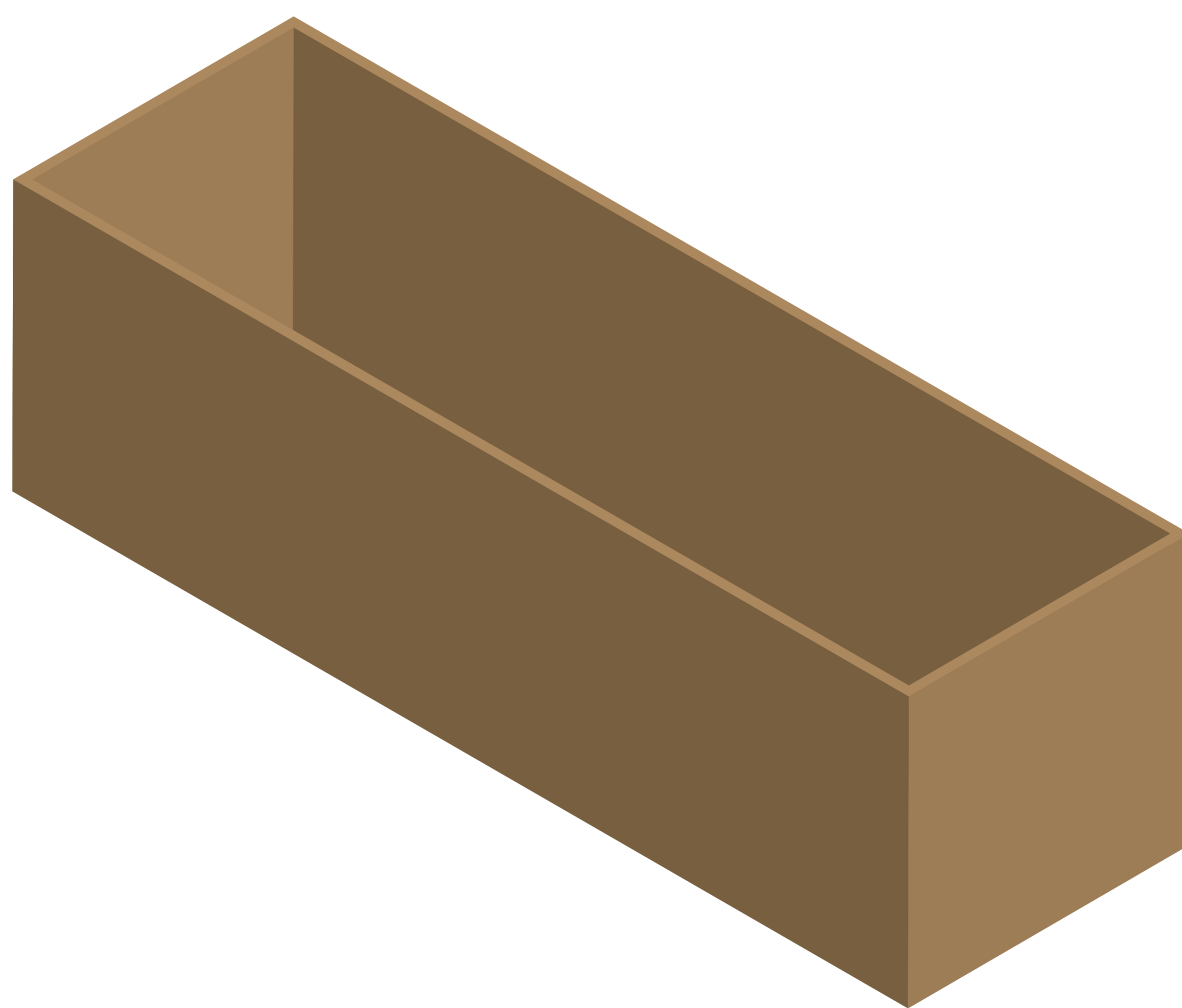
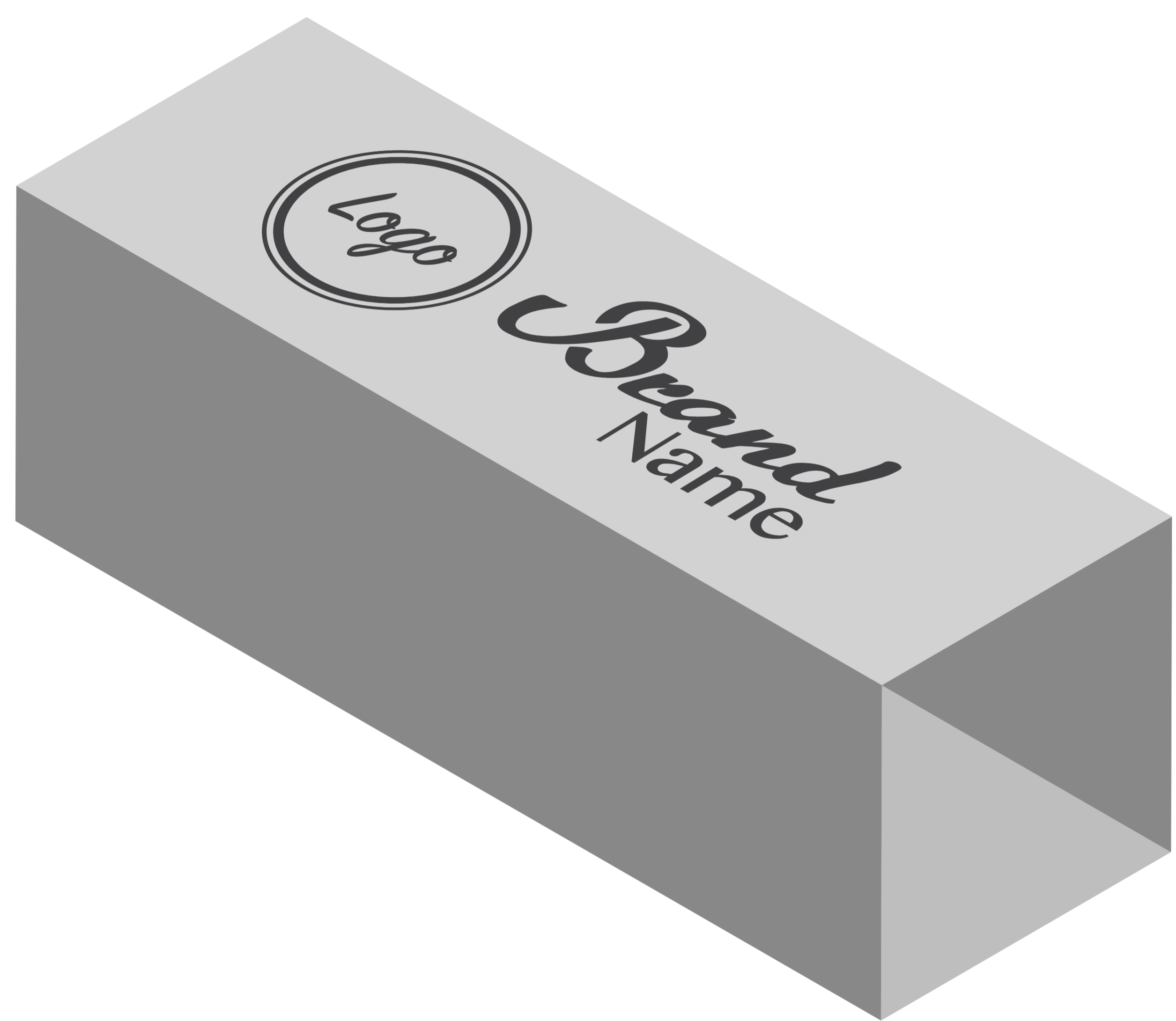
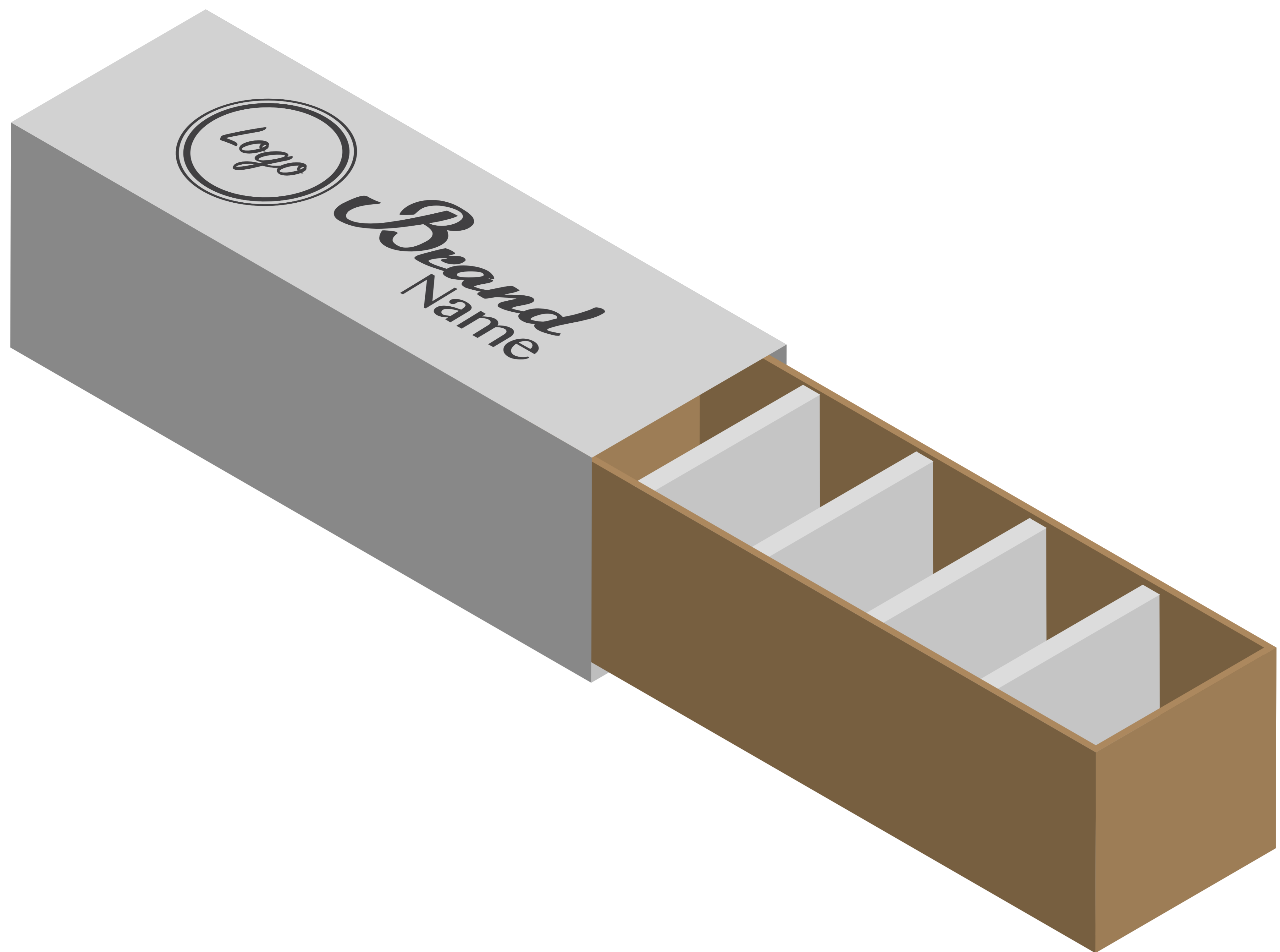
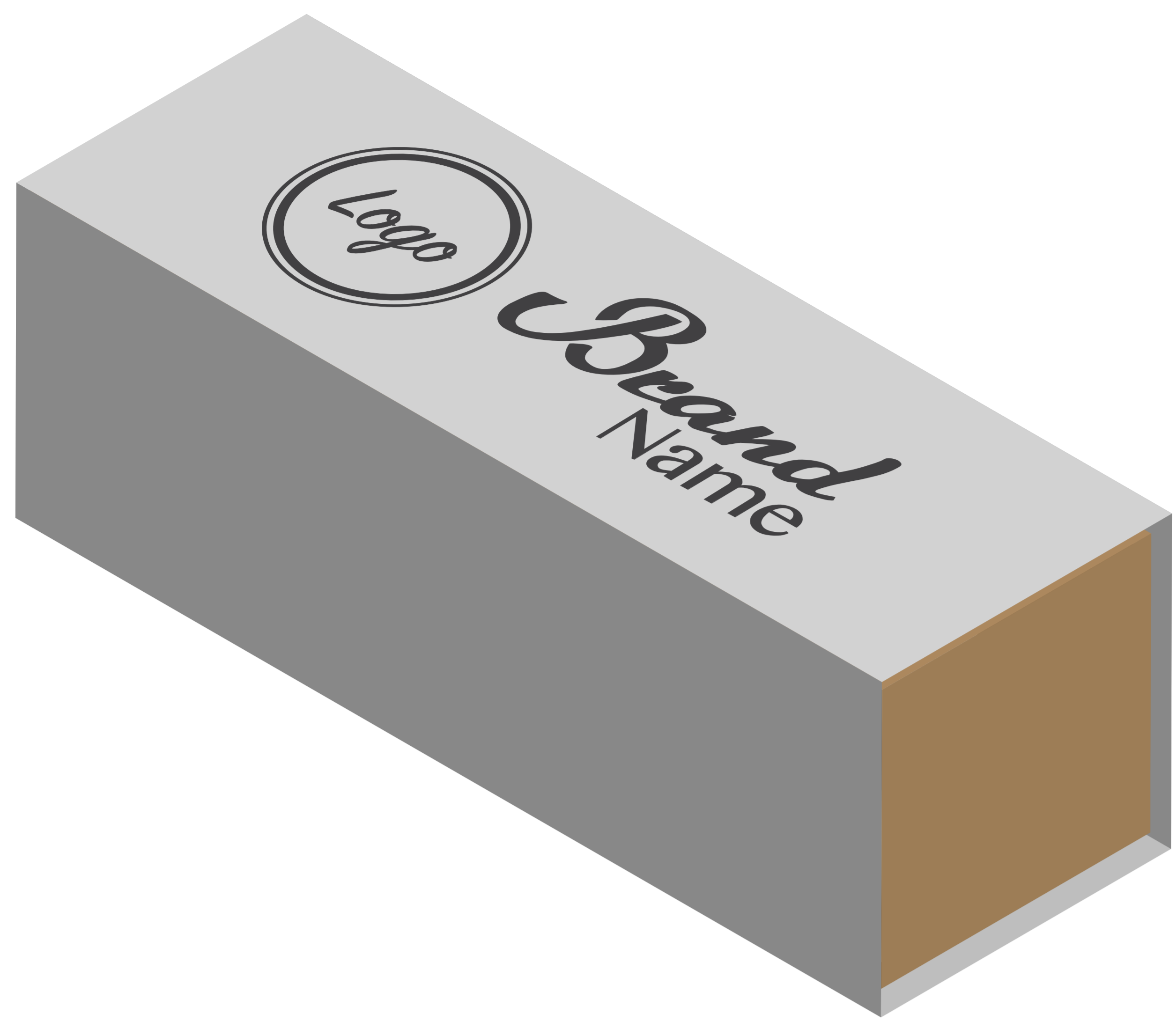

Hard Board Paper 0.14 cm
Bottom Box

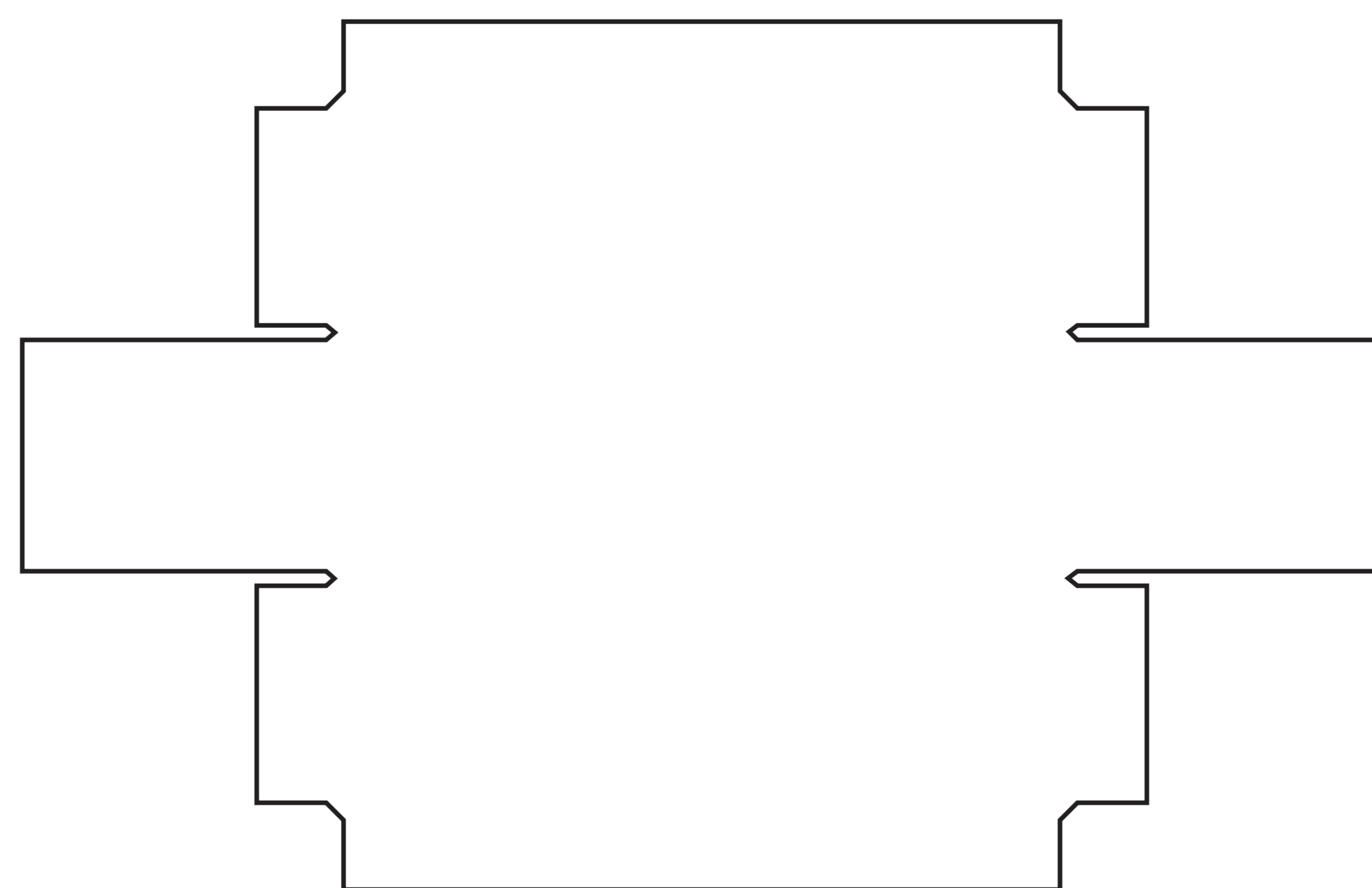

Wrapping Paper Bottom Box

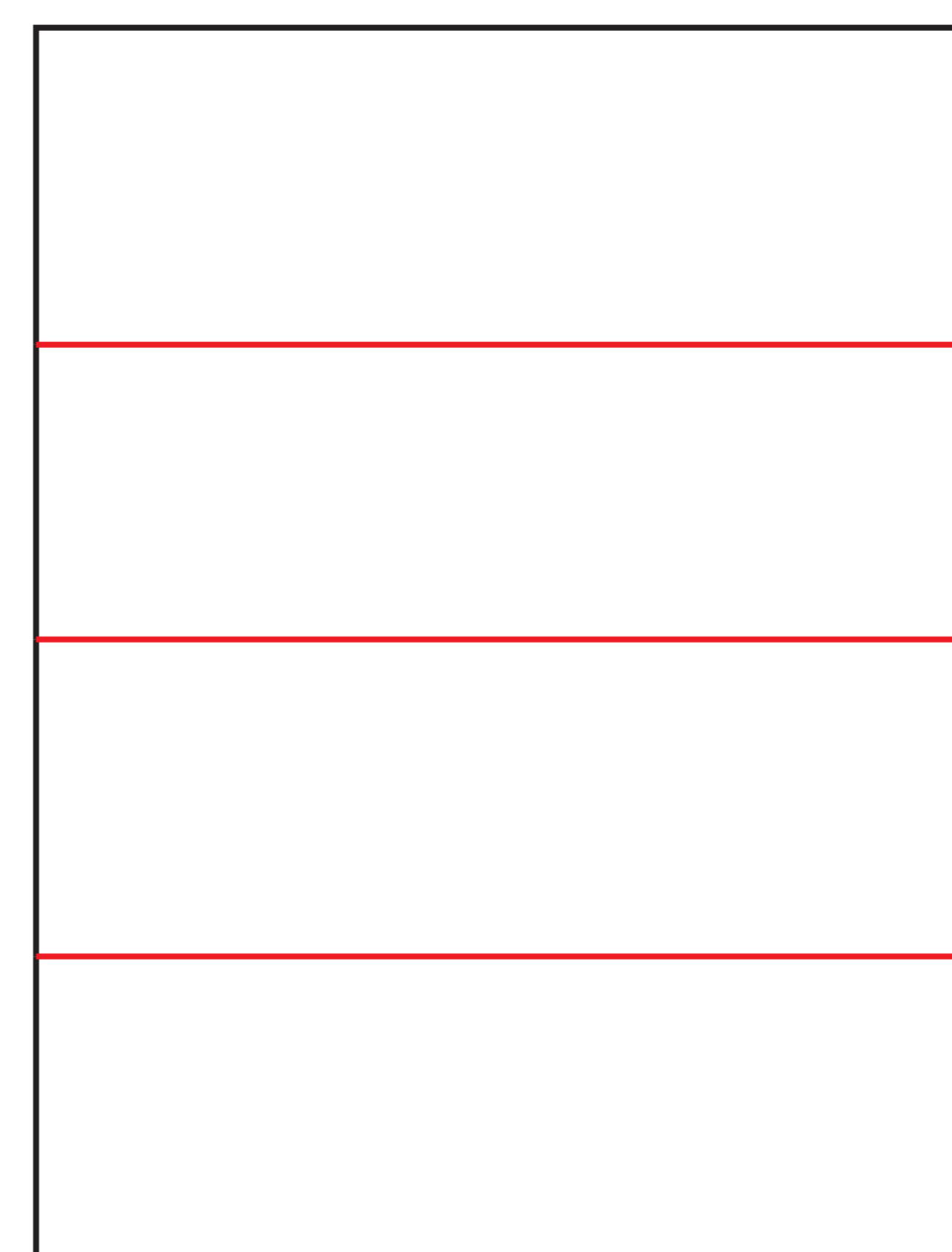

Hard Board Paper 0.14 cm
Top Box

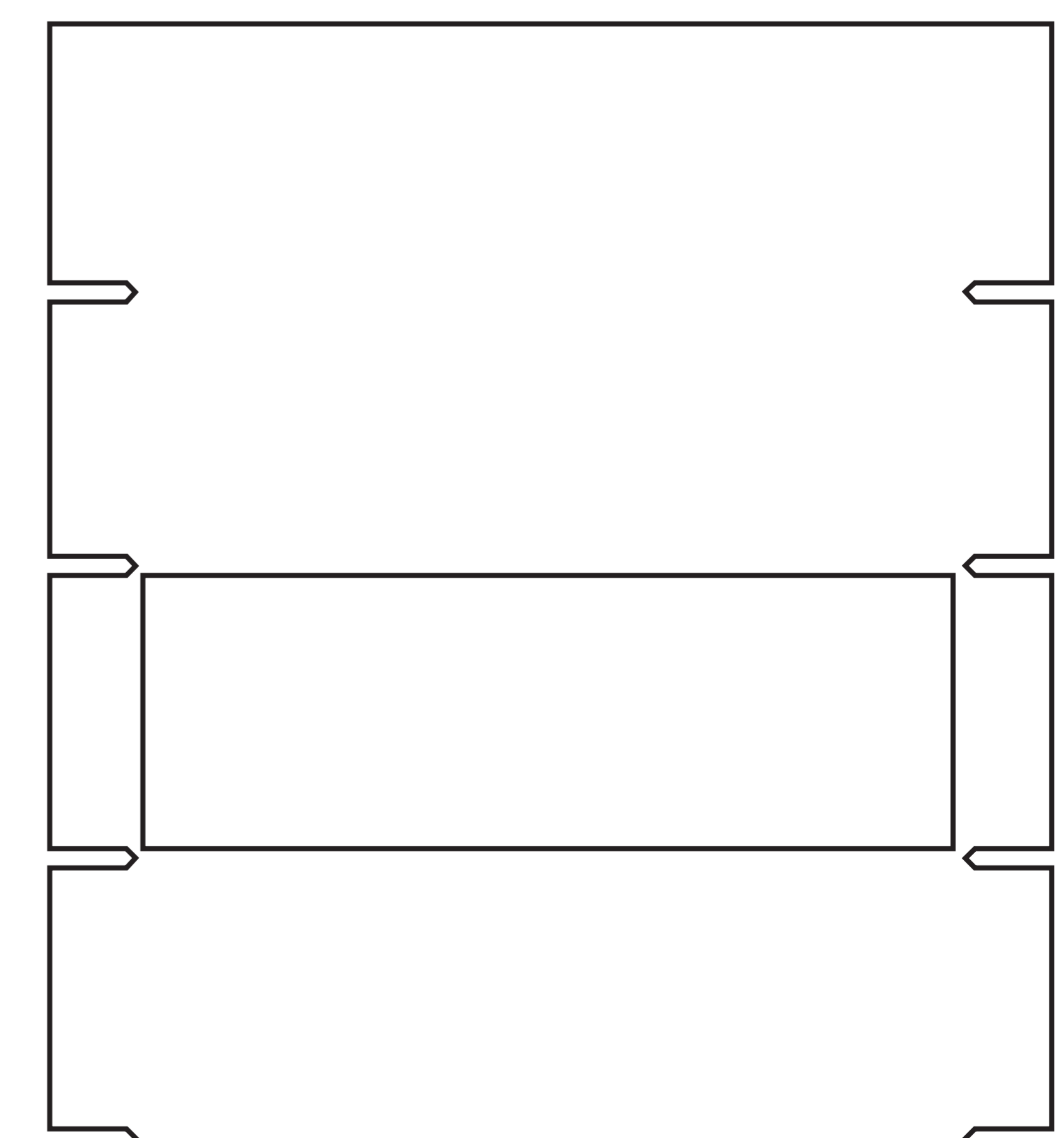

Wrapping Paper Top Box

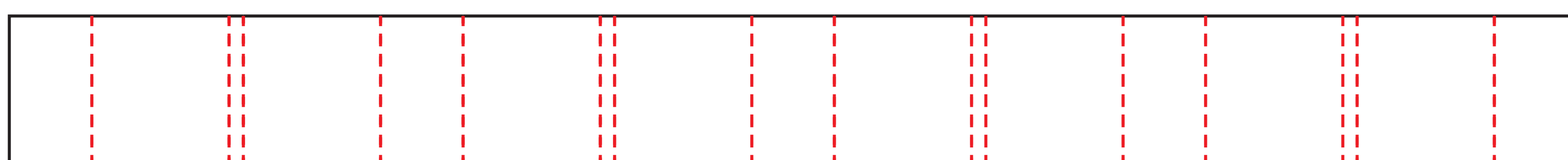

Hard Paper 350 gsm Product Partition

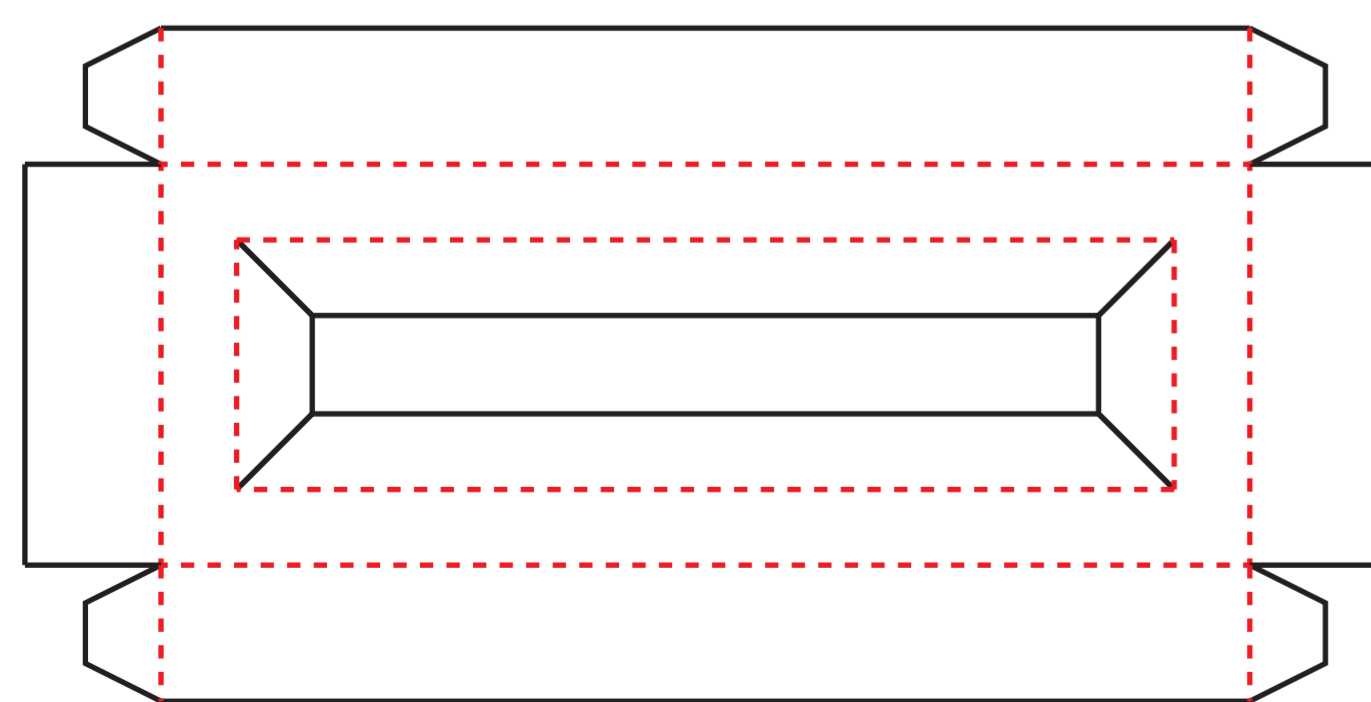
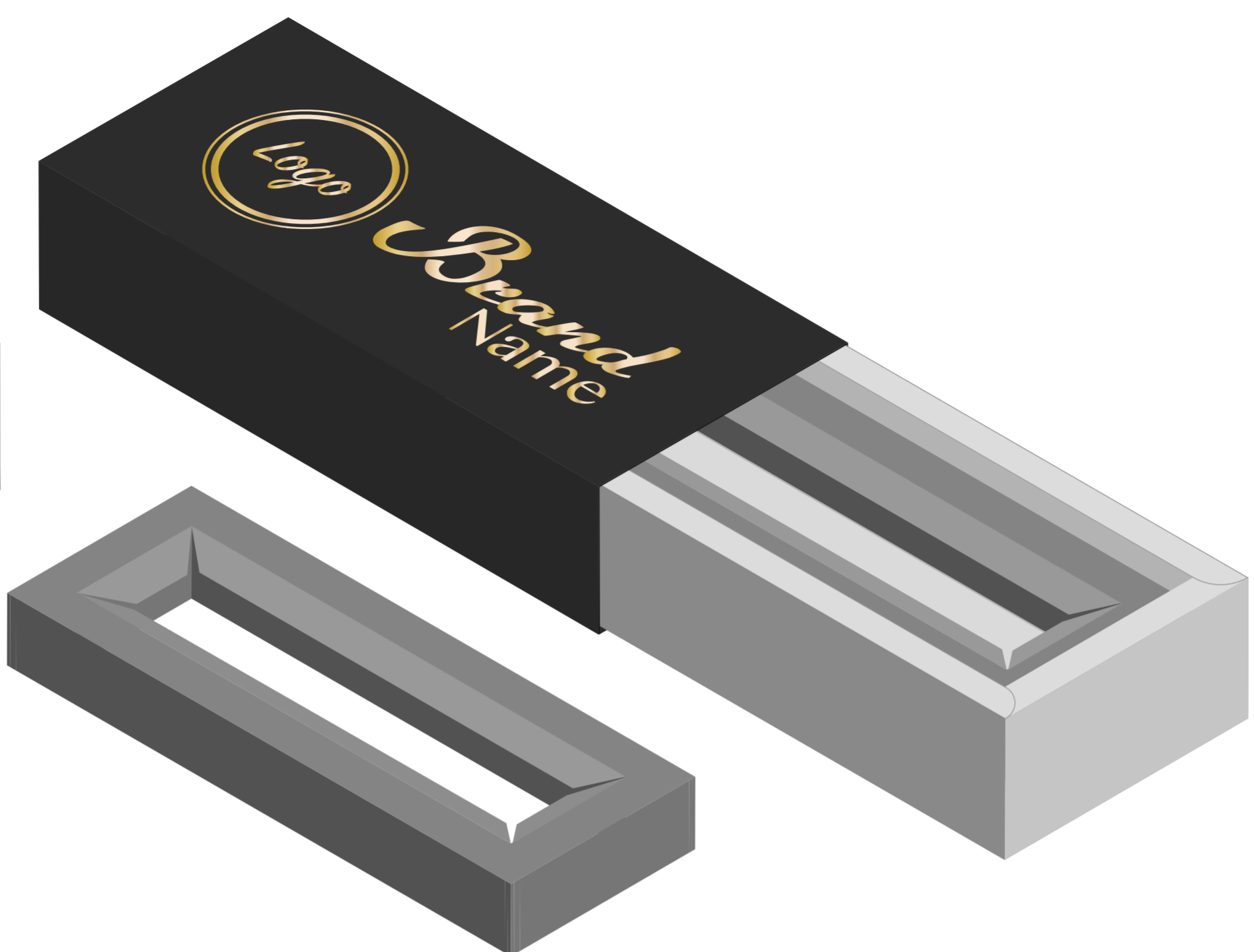

Hard Paper
300-350 gsm



Hard Paper
300-350 gsm

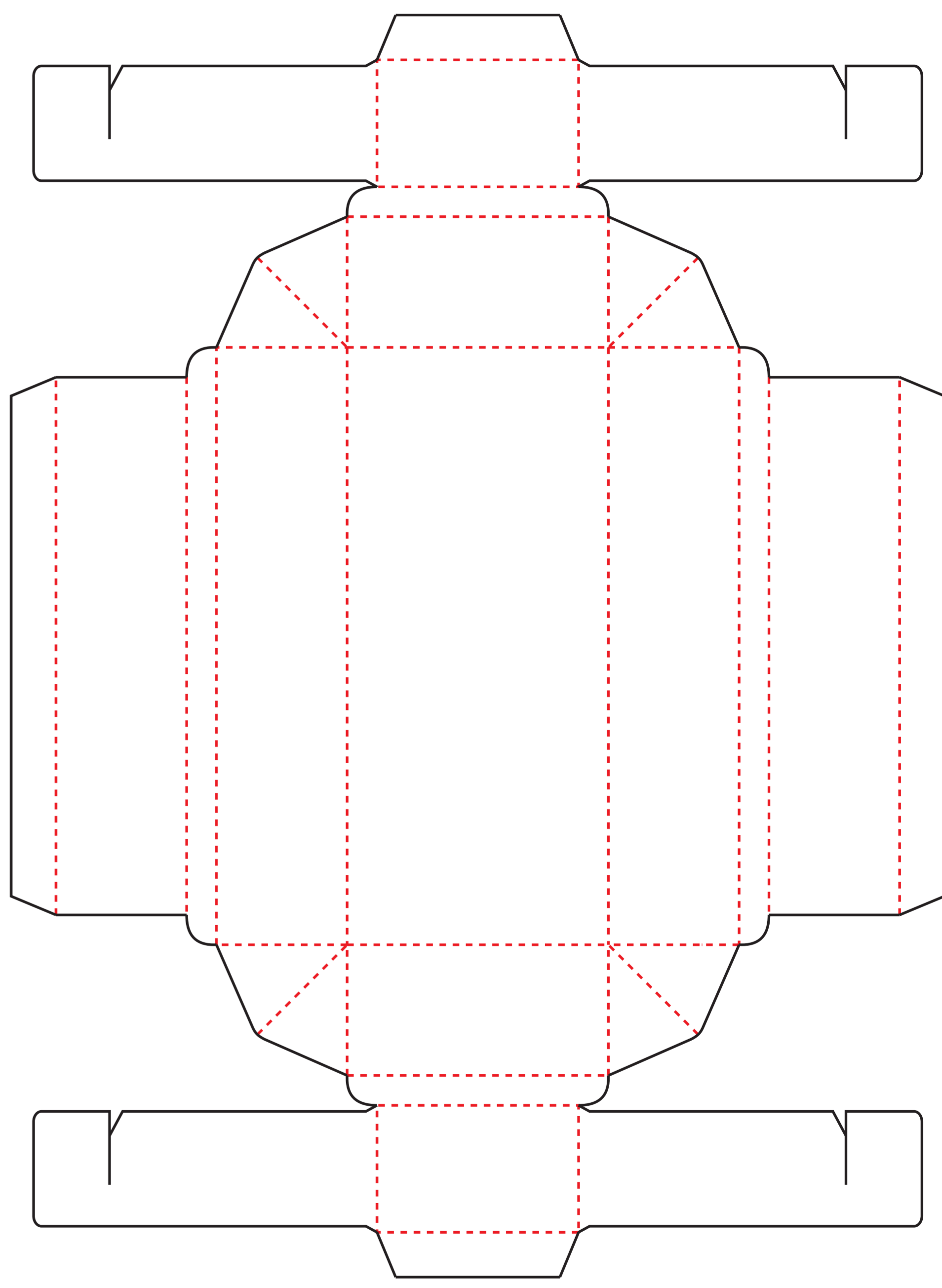

Hard Paper
200 -300 gsm

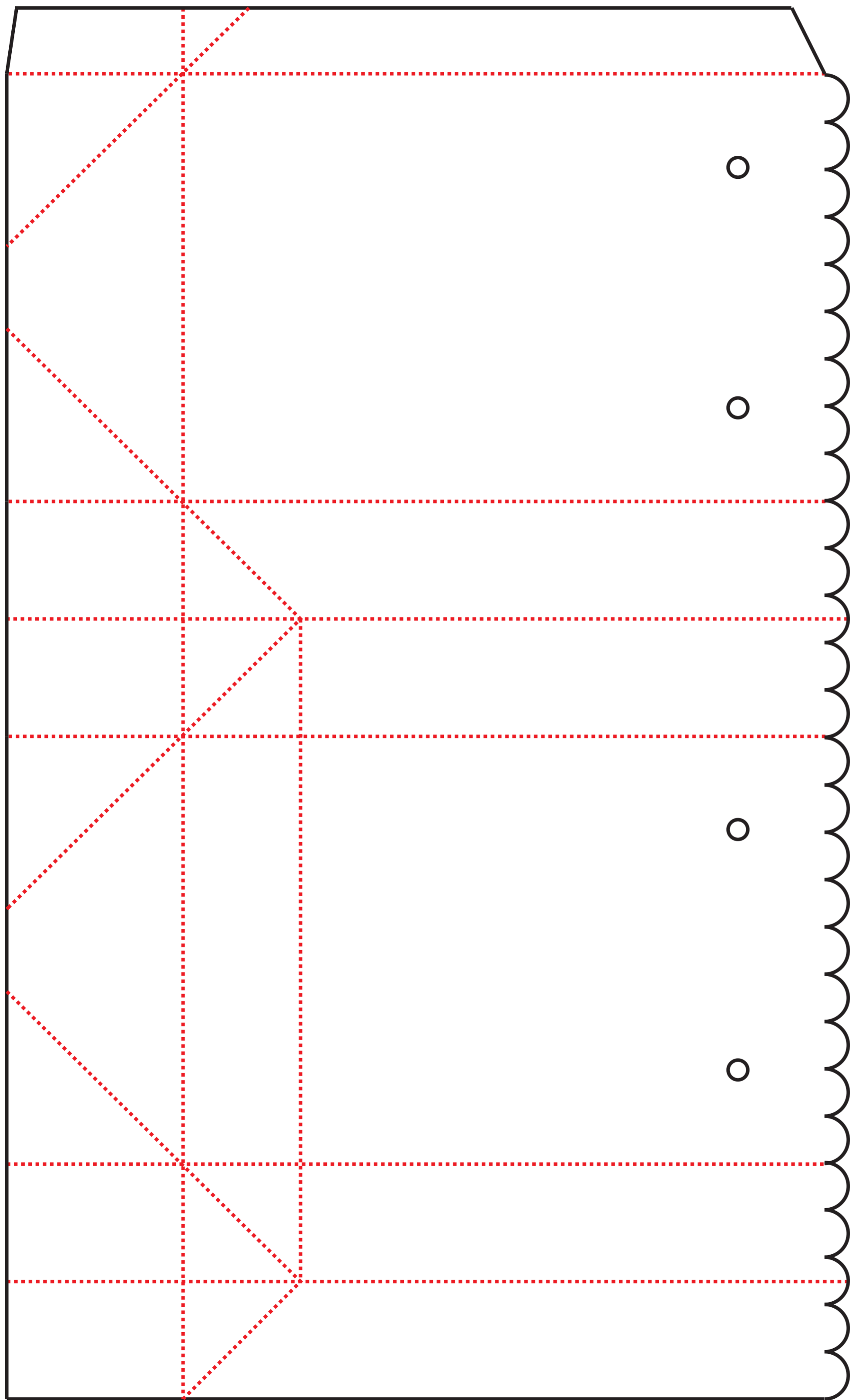

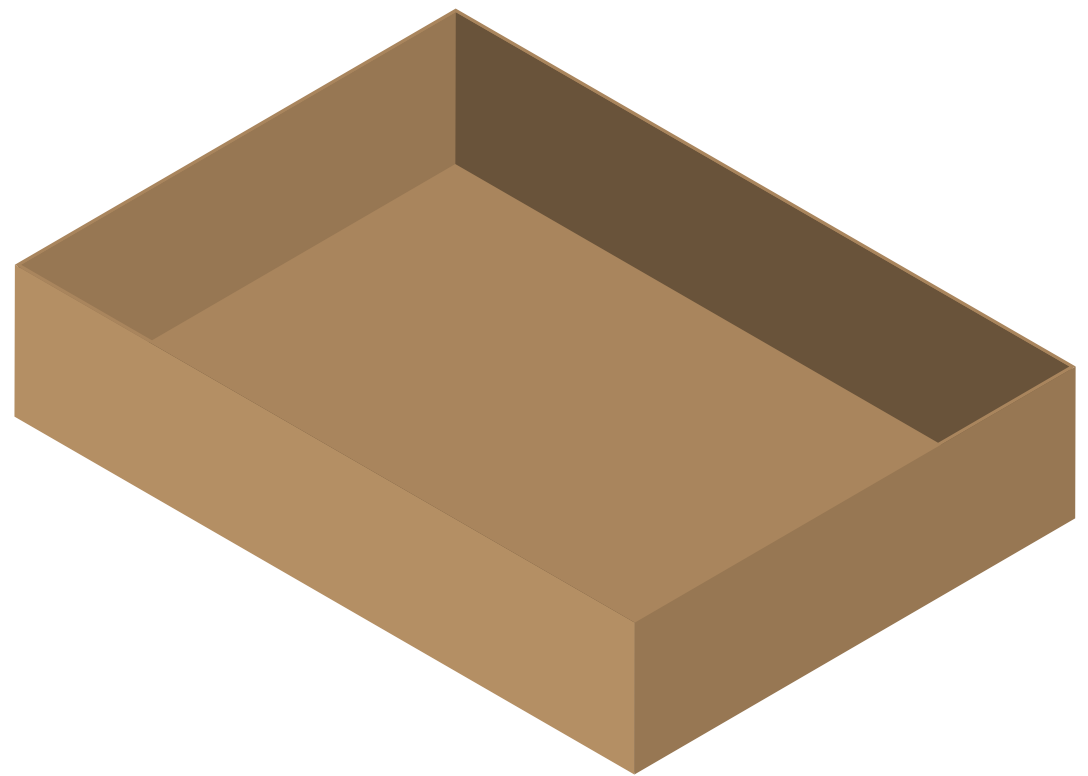

Hard Paper 250-350 gsm

