



**Manufacturers' Manual of NK105
Version G2-R6.10**

Preface

Thank you for choosing our products.

This manual will acquaint you with such detailed information of NK105 CNC integrated machine as system components, setup, usage, etc.

It introduces the process of system installing and various functions of the system. Before using this system and related equipments, please read through this manual, which will help you have a better use of the system.

Because of continuous updating of hardware and software, the products you bought may differ from the written in this manual, for which we apologize.

Precautions:

◆ Storage and Transportation

Attention
<ul style="list-style-type: none">➤ The products should be transported properly in terms of the weight;➤ Excess of specified quantity of stacking products is prohibited;➤ Climbing, standing or placing heavy loads on the products is prohibited;➤ Dragging or carrying the products via cables or devices connected to them is prohibited;➤ Keep the products free from moisture during storage and transportation.

◆ After Opening the Package

Attention
<ul style="list-style-type: none">➤ Please make sure whether the products are what you have ordered;➤ Check if the products are damaged in transit;➤ Check if the components and accessories are damaged or missing in terms of the detailed list;➤ Please contact us promptly if product discrepancy, accessory missing or transit damage occurs.

◆ Installation Notices

Attention

- Only when this equipment is installed in the qualified electricity cabinet can it be used. The construction of the cabinet must reach IP54 grade of protection.
- Paste sealing strips on the joint of the cabinet to seal all the cracks;
- Cable entry should be sealed while easy-to-open on the spot;
- Fan or heat exchanger should be adopted for the heat dissipation and air convection of the cabinet;
- If fan is adopted, air strainer is a must in air inlet or air outlet;
- Dust or cutting fluids may have access to the CNC device via the tiny cracks and tuyere. Therefore it is necessary to pay attention to the surroundings and air flow direction of the air vent to make sure that the outflow gas is towards pollution source.
- 100mm space should be preserved between the back of the CNC device and the cabinet wall for plugging cable connected with the device and for the ventilation & heat dissipation in the cabinet.
- Space between this device and other equipments should also be preserved according to the requirements.
- The product should be installed firmly and without vibration. During installing, casting, knocking, striking, or loading on the product is forbidden.
- To reduce electromagnetic interference, power-supply components used should be above AC or DC 50V and the space between cable and the CNC device should be preserved above 100mm.
- It will be better if the CNC device is installed on the position facilitating debugging and maintenance.

◆ Wiring Notices

Attention

- Only qualified people are allowed to participate in the wiring and checking.
- The CNC device should be grounded reliably and the grounding resistance should be less than 4 ohm. Neutral line is absolutely not allowed to replace earth wire. Otherwise, the device may be likely to work improperly due to the interference.
- Wiring should be firm and steady, or misoperation may occur.
- Voltage values and positive & negative polarity of any connection plug should be in accordance with the manual, or such breakdowns as short circuit and device permanent damage may occur.
- To guard against electric shock or the CNC device damage, fingers should keep dry before plugging or touching switch.
- The connecting wire should not be damaged and squeezed, or the leakage or short circuit may occur.
- It is prohibited to plug or open the chassis of CNC device when power on.

◆ Running & Debugging Notices

Attention

- Parameters setting should be checked before running, since wrong setting may lead to accidental movements.
- Modification to parameters should be within the allowable range, or such breakdowns as unsteady running and machine damage will occur.

◆ **Precautions in Use**

Attention

- Before power-on, please make sure that the switch is on blackout to avoid occasional start-up.
- Please check the electromagnetic compatibility during electrical design in order to avoid or reduce electromagnetic interference to the CNC device. A low pass filter should be employed to reduce electromagnetic interference if there are other electrical devices nearby.
- It is not allowed to frequently power on and power off. It is recommended 1 minute interval at least after power failure or blackout before power on again.
- Hold firmly a handheld box, which is the control terminal, when moving it to ensure the accuracy, promptness and safety of control, in case it falls to the ground or collides with sharp instruments and causes component damage and control failure, etc.

Contents

1. Summarization	1
1.1. Introduction to NK105.....	1
1.2. Mechanical Dimension	1
2. Wiring Method	3
2.1. Terminal Specification of NK105 Control Box.....	3
2.2. Input Interface of +24V Power	5
2.3. USB Interface	6
3. System Installation	7
3.1. Basic Configuration of Ncstudio	7
3.2. Ncstudio System Update	7
3.2.1. Configuration Update	7
3.2.2. System Mirror Update	7
3.2.3. System Application Update	7
4. Basic Concepts of NK105.....	9
4.1. Operation Mode and State.....	10
4.1.1. Operation Mode	10
4.1.2. Operation State	10
4.2. Machine Coordinate System	11
5. Functions & Operation Methods of Panel Keys.....	14
5.1. Brief Introduction.....	14
5.2. Function Information of Each Single-key.....	14
5.3. Function Information of Combination Key	16
5.4. Modification Method of System Parameters.....	17
5.5. System Start-up	18
6. Machine Tool Debugging.....	19
6.1. Adjustment of Axial Direction and Pulse Equivalent.....	19
6.1.1. Adjustment of Axial Direction	19
6.1.2. Adjustment of Pulse Equivalent.....	19

6.2.	Stroke Setup of Machine Tool.....	21
6.3.	Port Polarity	22
6.4.	Backing to Mechanical Origin	24
6.4.1.	Parameter Setup of Backing to Mechanical Origin.....	24
6.4.2.	Operation Mode of Backing to Mechanical Origin	24
6.5.	Spindle Debugging	25
6.5.1.	Spindle Setup.....	25
6.5.2.	Park MCS Site	26
6.5.3.	Spindle Stop.....	27
7.	Menu Page	28
7.1.	Summarization.....	28
7.2.	Browse Local Files/Browse USB Files	29
7.3.	Operations	30
7.3.1.	Backing to Mechanical Origin	30
7.3.2.	Rectangular Plane Processing	31
7.3.3.	Select Line No.....	31
7.3.4.	Machining Info.....	32
7.3.5.	Park MCS Site Setup.....	32
7.3.6.	Select WCS.....	32
7.4.	Oper Param (Operator Parameters).....	33
7.5.	Mfr Param (Manufacturer Parameters).....	36
7.6.	Param Upkeep (Parameter Maintenance).....	40
7.6.1.	Backup Parameters	40
7.6.2.	Restore Parameter Backups.....	40
7.6.3.	Restore Factory Parameters.....	40
7.6.4.	Export Parameters	41
7.6.5.	Import Parameters	41
7.7.	System Upkeep	41
7.7.1.	Language	42
7.7.2.	Export Log.....	42
7.7.3.	System Update	42
7.7.4.	Register.....	43
7.7.5.	Help.....	44
7.7.6.	Reboot	44
7.7.7.	Exit	45

7.8.	Diagnosis	45
7.8.1.	System Info	45
7.8.2.	Ports List	46
7.8.3.	Keypress Diag (Diagnosis)	46
7.8.4.	Inport Diag (Diagnosis)	46
7.8.5.	Outport Diag (Diagnosis)	46
8.	Processing Operations	47
8.1.	Manual Processing	47
8.1.1.	Mode Selection of Manual Processing	47
8.1.2.	Parameter Setting of Manual Processing	48
8.1.3.	WCS Selection	49
8.2.	Automatic Processing	50
8.2.1.	Load Files	50
8.2.2.	Confirm Workpiece Origin	51
8.2.3.	Start Processing	51
8.3.	Adjustment during Automatic Processing	51
9.	Function Information of Double-cylinder & Double-transducer	54
9.1.	Ports	54
9.2.	Related Parameters	54
9.3.	Programming Instructions	54
9.4.	Programming Example	55
9.5.	Keypresses	55
9.6.	Operating Instructions	56
9.7.	Motion Process during Machining	58
10.	Function Information of Three-cylinder & Single-transducer	59
10.1.	Ports	59
10.2.	Related Parameters	59
10.3.	Programming Instructions	59
10.4.	Programming Example	60
10.5.	Keypresses	61
10.6.	Operating Instructions	61
10.7.	Motion Process	61
11.	Driver	62

11.1.	Driver parameters	62
11.1.1.	Parameter Setting of YASKAWA Σ -II Servo Driver	62
11.1.2.	Parameter Setting of DELTA ASDA-A Servo Driver	64
11.1.3.	Parameter Setting of DELTA ASDA-A2 Servo Driver	66
11.1.4.	Parameter Setting of PANASONIC MINAS_A4 Servo Driver	68
11.1.5.	Parameter Setting of MITSUBISHI MR-E Servo Driver	69
11.1.6.	Parameter Setting of FUJI FALDIC- β Servo Driver	70
11.1.7.	Parameter Setting of STONE GS Servo Driver	71
11.2.	Wiring Diagram of NK105 and Driver	73
11.2.1.	Wiring Diagram of NK105 and Stepping Driver of Differential Input	73
11.2.2.	Wiring Diagram of YASKAWA Σ -II Servo Driver	74
11.2.3.	Wiring Diagram of DELTA ASDA_A Servo Driver	74
11.2.4.	Wiring Diagram of PANASONIC MINAS_A4 Servo Driver	75
11.2.5.	Wiring Diagram of MITSUBISHI MR-E Servo Driver	75
11.2.6.	Wiring Diagram of FUJI FALDIC- β Servo Driver	76
11.2.7.	Wiring Diagram of STONE GS Servo Driver	76



1. Summarization

1.1. Introduction to NK105

Embedded IPC-based, independently-developed NK105 provides user with a whole set of solutions on the basis of engraving machines.

NK105 integrated machine is composed of host system and operation panel. Also called control box, host system integrates system control card, terminal board and other parts, and makes connection with operation panel via 15-core extension cable.

The up and down ends of the back of the control box are used to inlay terminals while left side includes USB interface and DB15 interface. And DB15 interface has already been connected to operation panel when leaving factory. USB interface is for external connection with USB equipment (e.g. USB flash disk).

Also called handheld box, operation panel is similar to handwheel in size, concise and portable, connected with host system via 15-core extension cable. Independent working without distribution cabinet facilitates the machine tool control. And its moving distance is only restricted by length of extension cable.

1.2. Mechanical Dimension

The integral thickness of NK105 host system is 218.3mm with terminals embedded at its up and down ends. The mechanical dimension drawing of NK105 control box is shown in Fig. 1-1 (unit: mm).

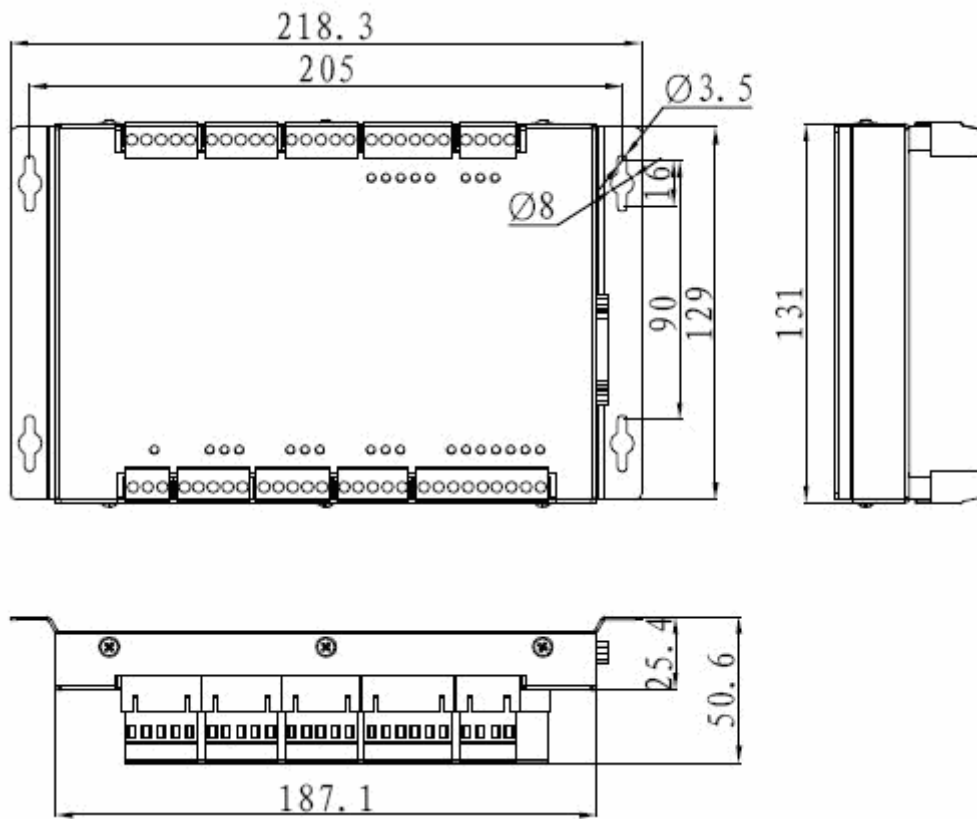

Fig. 1-1 Dimension drawing of NK105 control box

2. Wiring Method

2.1. Terminal Specification of NK105 Control Box

NK105 terminals are inlaid at the up and down ends of the control box. The detailed wiring diagram is as shown in Fig. 2-1.

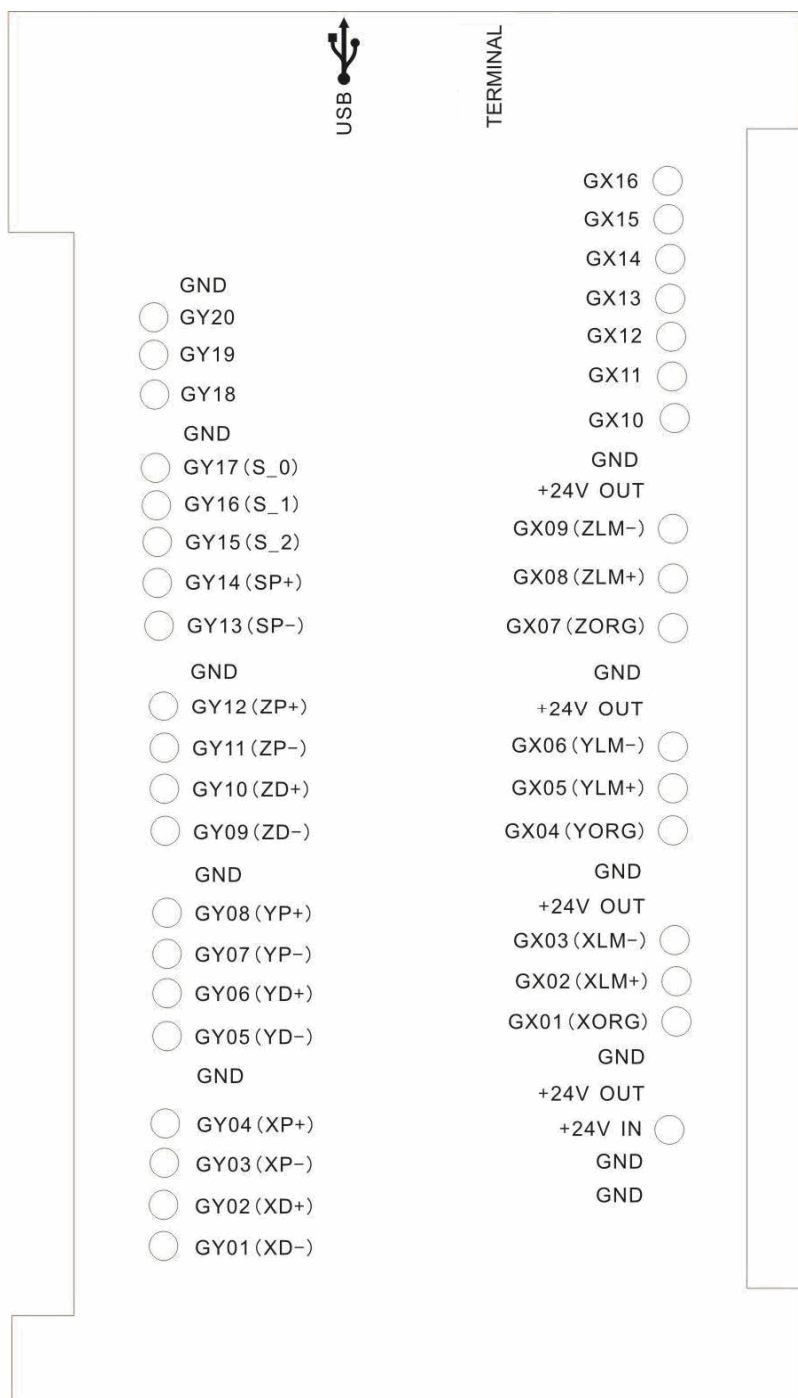

Fig. 2-1 Terminals on NK105 control box

The detailed explanation of terminal pin signals is as shown in Table 1 and Table 2.

Table 1 Output port signal explanation

Terminal name	Corresponding signal	Remark
GY01(XD-)	Negative differential signal along X-axis	XD+ and XD- are differential pair signals along X axis.
GY02(XD+)	Positive differential signal along X-axis	
GY03(XP-)	Pulse negative differential signal of X-axis	XP+ and XP- are differential pair signals of X-axis pulse.
GY04(XP+)	Pulse positive differential signal of X-axis	
GY05(YD-)	Negative differential signal along Y-axis	YD+ and YD- are differential pair signals along Y-axis.
GY06(YD+)	Positive differential signal along Y-axis	
GY07(YP-)	Pulse negative differential signal of Y-axis	YP+ and YP- are pulse differential pair signals of Y-axis.
GY08(YP+)	Pulse positive differential signal of Y-axis	
GY09(ZD-)	Negative differential signal along Z-axis	ZD+ and ZD- are differential pair signals along Z-axis.
GY010(ZD+)	Positive differential signal along Z-axis	
GY011(ZP-)	Pulse negative differential signal of Z-axis	ZP+ and ZP- are pulse differential pair signals of Z-axis.
GY012(ZP+)	Pulse positive differential signal of Z-axis	
GY013(SP-)	Spindle reverse rotation control port	Multi-step spindle gear control ports: they can provide at most 8-gear speed control; in wiring, COM of spindle needs joining to GND of terminal.
GY014(SP+)	Spindle forward rotation control port	
GY15(S_2)	2 nd gear output port of spindle speed	
GY16(S_1)	1 st gear output port of spindle speed	
GY17(S_0)	0 th gear output port of spindle speed	
GY18	Workpiece cooling output port	
GY19	Spindle coolant output port	
GY20	Auto lubricant output port	
+24V OUT	+24V output	It is connected with +24V power, available of use.

Table 2 Input port signal explanation

Terminal name	Corresponding signal	Remark
GND	Power GND or COM port	The two GND on power terminal are connected with power GND and earth respectively while GND on other terminals can be used as COM signal.
+24V IN	+24V DC power input	External connection with +24V DC power
GX01(XORG)	Mechanical origin signal of X-axis	External connection with mechanical, photoelectric and proximity switch
GX02(XLM+)	Positive limit signal of X-axis	External connection with mechanical, photoelectric and proximity switch
GX03(XLM-)	Negative limit signal of X-axis	External connection with mechanical, photoelectric and proximity switch
GX04(YORG)	Mechanical origin signal of Y-axis	External connection with mechanical, photoelectric and proximity switch
GX05(YLM+)	Positive limit signal of Y-axis	External connection with mechanical, photoelectric and proximity switch
GX06(YLM-)	Negative limit signal of Y-axis	External connection with mechanical, photoelectric and proximity switch
GX07(ZORG)	Mechanical origin signal of Z-axis	External connection with mechanical, photoelectric and proximity switch
GX08(ZLM+)	Positive limit signal of Z-axis	External connection with mechanical, photoelectric and proximity switch
GX09(ZLM-)	Negative limit signal of Z-axis	External connection with mechanical, photoelectric and proximity switch
GX10	Extended input 0	
GX11	Extended input 1	
GX12	Extended input 2	
GX13	Extended input 3	
GX14	Extended input 4	
GX15	E-stop alarm signal input	External connection with E-stop button of machine tool
GX16	Tool calibration input	

2.2. Input Interface of +24V Power

Input interface of +24V power is for external connection with 24V power. And its pin definition is as shown in Fig. 2-2, in which  is connected to grounding copper plate of machine tool, namely to earth.

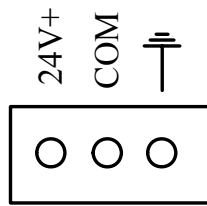

Fig. 2-2 Pin definition of +24V power input interface

2.3. USB Interface

The USB interface is used for externally connecting with USB device (e.g. USB flash disk).

3. System Installation

3.1. Basic Configuration of Ncstudio

◆ Basic Configuration of NK105 System

Memory:	128M
Flash:	256M
Monitor:	128 × 64 graphic LCD module

3.2. Ncstudio System Update

User can directly use the NK105 he got since the system has been installed. If breakdown occurs, user can update the system.

3.2.1. Configuration Update

Prepare an USB flash disk (above 1G) with the system image and application to be updated.

3.2.2. System Mirror Update

1. Insert the USB flash disk, with the system mirror “EBOOT105.nb0”, “NK105.nb0” and system application to be updated under its root menu, into the USB interface of NK105 control box.

2. Power on NK105, and then press the “Menu” key  to enter update selection interface automatically. Press “3” to select “OS” to start updating system image. Note that this process is a little long, about 3 minutes. After write-in finishes, “USB Available Now!” will be displayed on the screen. And then press “OK” key to enter update system interface in which select “Delete parameters”. After configuration files are deleted, select “Update system” to start updating the system application. After update completes, the system will be rebooted automatically.

Notice:

Ex-factory parameters need restoring after each system update. If “Delete parameters” is not selected in the process of update, it is a must to restore ex-factory parameters after updating system, following the below

method: after the system is rebooted, press  to enter menu page; and then select “6. Param Upkeep”, “3. Factory Params” sequentially, and then operate according to the prompt on the screen.

3.2.3. System Application Update

System application update is included in the process of system image update. If system image

does not need update, system application can be updated directly following the below steps:

1. Insert the USB flash disk, with the system application to be updated under its root menu, into the USB interface of NK105 control box.

2. Power on NK105, then press  to enter menu page after entering system interface, and then select “7. System Upkeep” and “3. System Update” in turn, and then operate according to the prompt on the screen until “USB Available Now” appears. And then press “OK” key to enter update system interface in which select “Delete parameters”. After configuration files are deleted, select “Update system” to start updating the system application. After update completes, the system will be rebooted automatically.

Notice:

Ex-factory parameters need restoring after each system update. If “Delete parameters” is not selected in the process of update, it is a must to restore ex-factory parameters after updating system, following the below

method: after the system is rebooted, press  to enter menu page; and then select “6. Param Upkeep” and “3. Factory Params” sequentially, and then operate according to the prompt on the screen.

4. Basic Concepts of NK105

NK105 system involves various concepts, like workpiece coordinate system, mechanical coordinate system, operation mode, and operation state, etc. It is inevitable for user to escape from them in using. Therefore, it will be better if user grasp them before using NK105.

4.1. Operation Mode and State

4.1.1. Operation Mode

Regarding users' operation to the machine tool, there are several operation modes as below. And it's very important to comprehend them for correct operation.

◆ Auto Mode

Under automatic operation mode, the machine tool generates motions through the procedure loaded in advance. Therefore, the processing procedure must have been loaded.

◆ Manual Mode

To meet the requirements of manual motion under different situations, the system provides “Jog” and “Step” motion modes.

- Jog motion mode: there is no concrete data control under this mode, fit for tuning the mechanical coordinates roughly.
- Step motion mode: this motion mode is applicable to tuning the mechanical coordinates accurately.

4.1.2. Operation State

In terms of the motion mode of the machine tool, each operation mode can be divided into the following types of operation states; it is operation mode and operation state that decide the state of the machine tool.

◆ IDLE State

Idle state is the most common state. Under this state, the machine has no motion to output, but is ready to accept any new task.

◆ ESTOP State

This is an abnormal state. When there is an error in the hardware of machine tool, the system will enter into this state and implement the predetermined protection actions, such as closing spindle motor and cooling pump. Under this state, the machine tool is locked and can not carry out any new action.

◆ Running State

When the machine tool is implementing any action, the system enters into Running State.

◆ Pause State

When a machine tool is running, if user presses the combination key of “pause during processing”, the system will enter into PAUSE state and wait for further instruction. At this time, user can press the “Start” key to make the system enter into “Running” state, or press the “Stop/ Cancel” key to make the system stop.

◆ **LOCK State**

Lock state is an internal state occurring at the time of software limit operation.

4.2. Machine Coordinate System

Coordinate system is a terminology that is used to describe the motion of the machine tool. For the sake of unification, standard coordinate system adopts the right-hand rule. See Fig. 4-1.

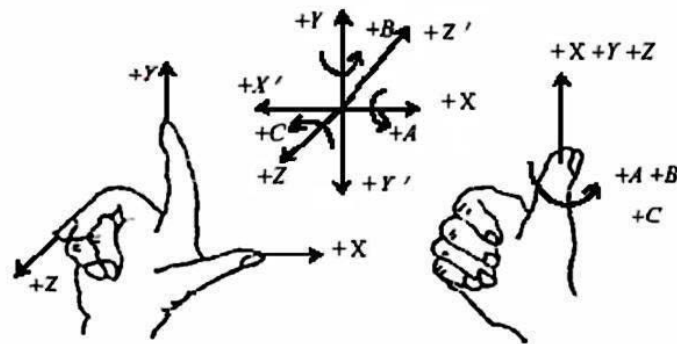

Fig. 4-1 The coordinate system conforming to right-hand rule

For milling machines, the direction of machine axes is decided by both the type of machine tool and the layout of each component. The basic coordinate axes of milling machines are X-axis, Y-axis, and Z-axis:

——Z axis is coincidental with spindle axis and the direction of the cutter moving away from workpiece is its positive direction (+Z).

——X-axis is perpendicular to Z-axis and parallel to the clamped surface of workpiece. For the single column vertical milling machine, if user faces the spindle and looks in the column direction, right moving direction is its positive direction (+ X).

——X-axis, Y-axis and Z-axis constitute the coordinate system adhering to the right-hand rule.

◆ **Mechanical Coordinate System**

Mechanical coordinate system is a set of fixed right-hand coordinate system. Its coordinate origin is a fixed position that corresponds to the machine tool. Therefore, at any time, a certain point in space can be exclusively fixed by mechanical coordinate system.

The mechanical coordinate system requires the machine available of function of [back to mechanical origin], or this concept will only appears in the software.

◆ Workpiece Coordinate System

As a set of right-hand coordinate system for the programmer, workpiece coordinate system is used in programming. To establish it, the programmer can select a given point on the workpiece as the origin (also called program origin). The origin of workpiece coordinate system (namely the workpiece origin) is fixed relative to a certain point on the workpiece, so it can be floating with respect to the origin of mechanical coordinate. The origin of workpiece coordinate system should be selected meeting such conditions as simple programming, simple dimension conversion and small machining errors caused.

Workpiece offset corresponds to the coordinate systems G54, G55, G56, G57, G58 and G59. After the system is opened, the default coordinate system is G54, and the relation between workpiece offset and mechanical coordinate system is as shown in Fig. 4-2.

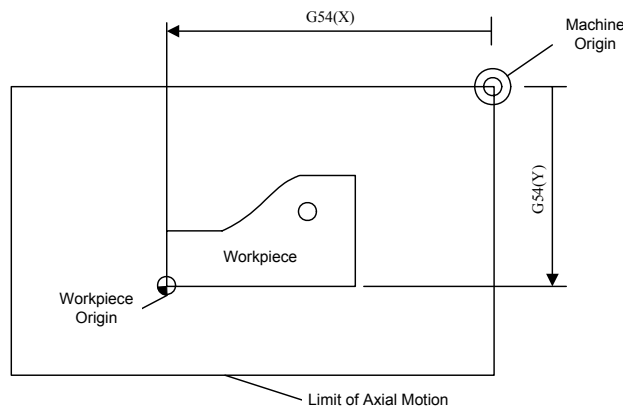

Fig. 4-2 The relation between workpiece offset and mechanical coordinate system

One, two or several workpiece offsets can be used in the machining program. As shown in Fig. 4-3, three workpieces are installed on the work table, so each workpiece has a workpiece origin corresponding to the G code of workpiece coordinate system. Drill a hole on each of the workpiece, with calculation depth as Z-0.14, and the programming example is as follows.

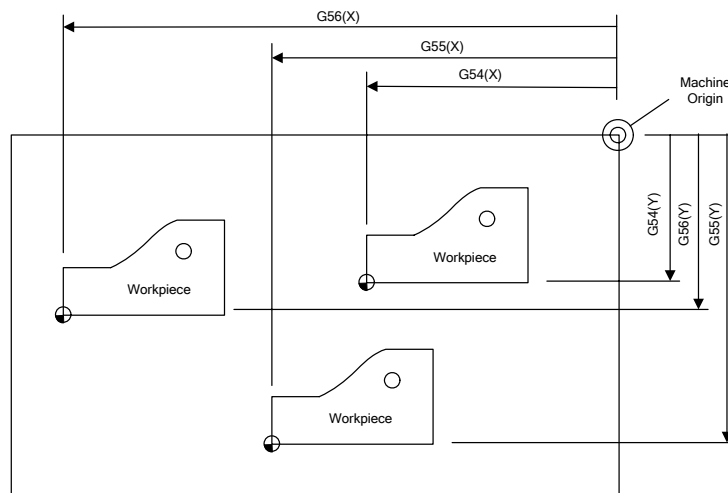

Fig. 4-3 Example figure

```
O1801
N1 G20
N2 G17 G40 G80
N3 G90 G54 G00 X5.5 Y3.1 S1000 M03      (Use G54)
N4 G43 Z0.1 H01 M08
N5 G99 G82 R0.1 Z-0.14 P100 F8.0
N6 G55 X5.5 Y3.1                        (Switch to G55)
N7 G56 X5.5 Y3.1                        (Switch to G56)
N8 G80 Z1.0 M09
N9 G91 G54 G28 Z0 M05                    (Switch to G54)
N10 M01
```

...

Program segment N3~N5 is related to the first workpiece, within the G54 workpiece coordinate system; program segment N6 drills the hole in the second workpiece of the same batch within the G55 workpiece coordinate system; program segment N7 drills the third hole in the third workpiece of the same batch within the G56 workpiece coordinate system.

Aiming at all the coordinate systems, public offset is used to adjust the workpiece origin of X, Y and Z axes, without changing the offset value of G54~G59.

Workpiece offset, tool offset and public offset meet the following expression:

Workpiece coordinate = Mechanical coordinate – Workpiece offset – Tool offset – Public offset

5. Functions & Operation Methods of Panel Keys

5.1. Brief Introduction

The layout of panel keys is as shown in Fig. 5-1.

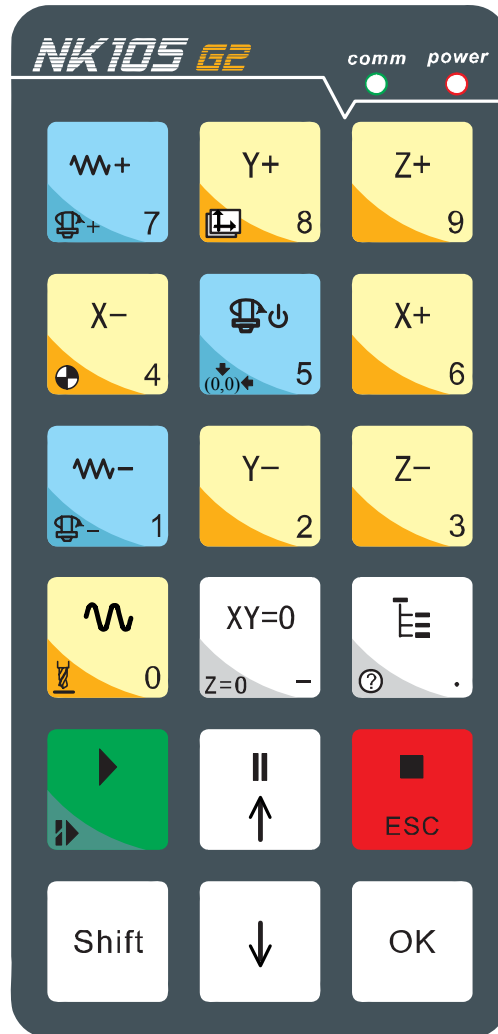

Fig. 5-1 Panel keys of NK105

5.2. Function Information of Each Single-key

NK105 operation panel is both light and concise. With a single-key or combination key, all the operations can be realized. The usage of each single-key is: press a key lightly to complete the called function and then release the key, except that mode shift key is valid when pop-up. Function information of each single-key is as Table 3.



















Table 3 Single-key function table

Key icon	Key name	Function
	Override+	Increase of feedrate override; input of number 7; increase of spindle gear with the help of auxiliary key when spindle port has input
	Y+	Positive shift of Y axis; input of number 8; switch between MCS and WCS with the help of auxiliary key
	Z+	Positive shift of Z axis; input of number 9
	X-	Negative shift of X axis; input of number 4; returning to mechanical origin with the help of auxiliary key
	Spindle start/stop	Start or stop of spindle under manual mode; input of number 5; backing to workpiece origin with the help of auxiliary key
	X+	Positive shift of X axis; input of number 6
	Override-	Decrease of feedrate override; input of number 1; decrease of spindle gear with the help of auxiliary key when spindle port has input
	Y-	Negative shift of Y axis; input of number 2
	Z-	Negative shift of Z axis; input of number 3
	Speed switchover	Switch between manual high/low speed; input of number 0; tool presetting with the help of auxiliary key
	Backing to origin	Backing to origin of X and Y axes; input of minus; backing to origin of Z axis with the help of auxiliary key
	Menu	Entering menu page; input of decimal point; entering image update page at the time of system start-up
	Start	Start key; breakpoint resuming with the help of auxiliary key
	Up	Suspend processing; up direction key
	ESC	Stop processing; cancellation of various selections, inputs and operations
	Shift	Auxiliary key
	Down	Down direction key
	OK	Entering manual high/low speed adjustment page under menu page; confirmation of various selections, inputs and operations

5.3. Function Information of Combination Key

The usage of combination key is as follows: press the first key then the second; release the two keys simultaneously after the corresponding content appears.

Table 4 Combination key function table

Key icon	Function
 + 	Increase of spindle gear
 + 	Switch between WCS and MCS
 + 	Backing to mechanical origin
 + 	Backing to workpiece origin
 + 	Decrease of spindle gear
 + 	Floating presetting
 + 	Z clear
 + 	Breakpoint resuming
 + 	Entering help page

5.4. Modification Method of System Parameters

Modification of system parameters can be divided into two types.

◆ Input of Numerical Value

After entering parameter modification page, directly input the desired digit, and then press [OK] to save it or press [ESC] to return to the previous menu. Only when [OK] is pressed can the modification be saved after parameter modification each time.

For example: modification method for the parameter “REFP Speed” is as follows.

Speed (mm/min)	
X Axis:	1800.000
Y Axis:	1800.000
Z Axis:	1500.000

Fig. 5-2 Modification interface of “REFP Speed”

Press “Menu” key→ select 5. Mfr Param→ select 5. REF. Point Set→ select 1. REFP Speed, and then press [OK] key to enter the interface shown in Fig. 5-2, and then press “Up” and “Down” key to select the axis speed parameter to be modified. When the cursor is on the item currently selected, enter the new parameter value directly and then press [OK] to save it.

Note:

If you switch to another parameter without saving the input value during parameter modification, this new value will not be saved and the original value will be restored.

◆ Parameter Item Selection

Select a parameter item by directly pressing “UP” or “Down” key.

For example: modification method for the parameter “REFP Dir” is as follows.

Homing Direction	
X Axis:	Negative
Y Axis:	Positive
Z Axis:	Positive

Fig. 5-3 Modification interface of “REFP Dir”

Press “Menu” key→ select 5. Mfr Param→ select 5. REF. Point Set→ select 2. REFP Dir, and then press [OK] key to enter the interface shown in Fig. 5-3, and then press “Up” and “Down” key to select the axis direction parameter to be modified. When the cursor is on the item currently selected, press [OK] key to enter the interface shown in Fig. 5-4, arrow indicating the currently selected item. Then press [Up] or [Down] key to select the desired item, and then press [OK] key to confirm the

modification.

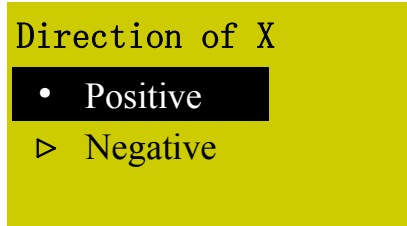

Fig. 5-4 Selection dialog

5.5. System Start-up

The system interface is as shown in Fig. 5-5 after power on.

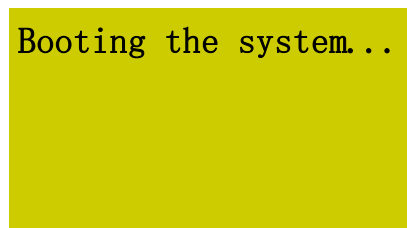

Fig. 5-5 System start-up interface

After system boot-up, "Back to REF. Point" will be prompted firstly, as shown in Fig. 5-6. Please press [ESC] to cancel this operation. You need to adjust the following related parameters: port polarity (see chapter 6.3), pulse equivalent (see chapter 6.1), axial output direction (see chapter 6.1) and machine stroke (see chapter 6.2) before executing returning to backing to reference point.

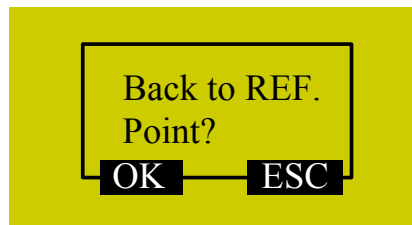

Fig. 5-6 Prompt for backing to reference point at boot-up

6. Machine Tool Debugging

6.1. Adjustment of Axial Direction and Pulse Equivalent

6.1.1. Adjustment of Axial Direction

Firstly confirm the positive direction of each axis according to the coordinate system of right-hand rule during the process of machine debugging, i.e. the feed motion direction of cutter is relative to the workpiece which is supposed to be still.

After fixing the positive direction of each axis following the right-hand rules, manually operate the machine to check if the axis moves correctly. If the direction is opposite, please modify the parameter “Axis Output Dir”. Take X-axis as an example, manually move X-axis; if you find it moves oppositely, just change the value of X axis in the parameter “Axis Output Dir” from “Positive (Negative)” to “Negative (Positive)”.

The method is: press “Menu” key→ select 5. Mfr Param→ select 2. Axis OutpDir, and then press [OK] key to enter the interface shown in Fig. 6-1.

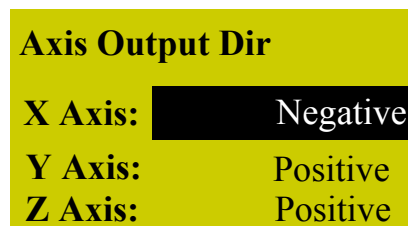

Fig. 6-1 Modification interface of “Axis Output Dir”

6.1.2. Adjustment of Pulse Equivalent

Pulse equivalent: the moving distance of workbench or rotation degree of rotary axis corresponding to one pulse sent by CNC device, the minimum available distance controlled by CNC system as well. This item can be calculated in terms of information of screw pitch, electronic gear ratio, mechanical deceleration ratio, etc.

The smaller the pulse equivalent is, the higher the machining precision and surface quality will be. At the meanwhile, the setting value of pulse equivalent decides the max. feed speed, and the relationship between pulse equivalent and max. feed speed is shown in the following expression:

$$\text{Max. feed speed(mm/min)} = \text{Pulse equivalent(mm/p)} \times \text{Hardware frequency(p/s)} \times 60(\text{s/min})$$

The hardware frequency of NK105 is 320 KHz; when pulse equivalent is 0.001mm/p, the max. feed speed of machine tool is 19.2m/min.

Lower pulse equivalent should be set under the condition of meeting the demand of feed speed.

◆ **Pulse Equivalent Setup of Linear Axis**

The calculation of pulse equivalent varies with different motor systems.

➤ Stepping motor

$$\text{Pulse equivalent} = \frac{\text{lead screw pitch}}{\frac{360}{\text{stepping angle}} \times \text{subdivision} \times \text{mechanical deceleration ratio}}$$

Hereinto, mechanical deceleration ratio= rotary speed input in reducer / rotary speed output
=teeth number of driven gear / teeth number of driving gear.

For instance, the selected screw lead of X-axis for a certain type machine tool is 5mm, and the stepping angle of stepping motor is 1.8 degree, with “10” subdivision and motor directly connected with lead screw by coupling. Thus, the pulse equivalent of X-axis is:

$$\text{Pulse equivalent} = \frac{5\text{mm}}{\frac{360}{1.8} \times 10 \times 1} = 0.0025\text{mm/p}$$

➤ Servo motor

$$\text{Electronic gear ratio} \frac{B}{A} = \frac{\text{encoder resolution}}{\frac{\text{screw pitch}}{\text{pulse equivalent}}} \times \text{mechanical deceleration ratio}$$

Electronic gear ratio: if servo motor makes one circle per every 5000 pulse commands sent by the system, setting electronic gear ratio of servo motor can make servo rotate twice with the same amount of pulse commands (please refer to parameter setting of each server brand).

Please see the servo motor label plate and then refer to the corresponding manual to confirm its encoder resolution. A label plate of YASKAWA SGMSH type motor is as below, and the 4th character in motor type is the serial encoder specification, so the resolution of this motor is 2¹⁷, i.e. 131072.

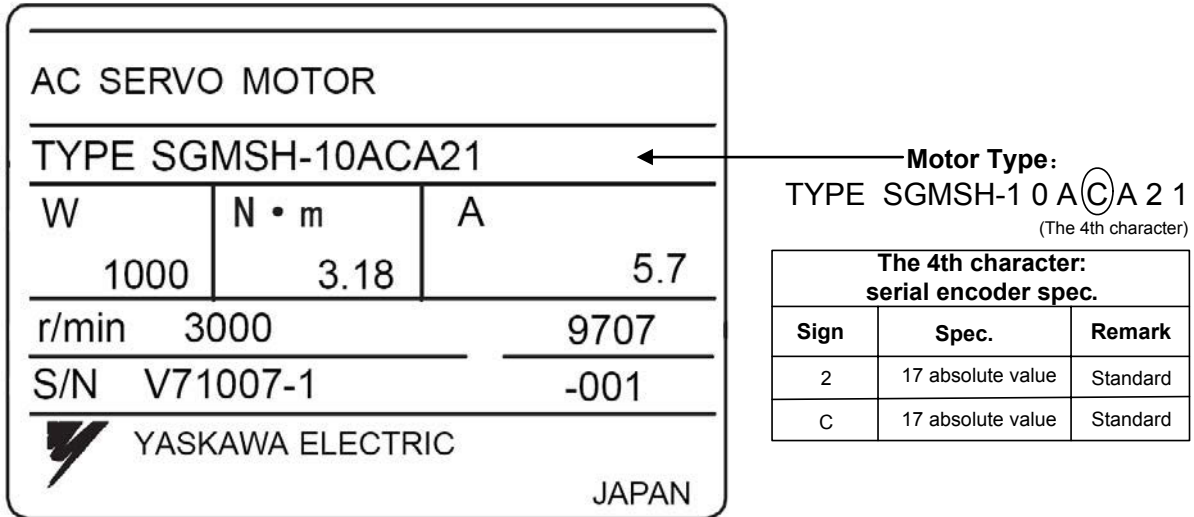

Fig. 6-2 Name plate of servo motor-encoder resolution

For instance: (an example of YASKAWA) the lead screw pitch of a certain type machine is 5mm, with 17 bit encoder resolution, “0.0001mm/p” pulse equivalent and “1:1” deceleration ratio.

$$\text{Electronic gear ratio} \frac{PN202}{PN203} = \frac{2^{17}}{5/0.0001} \times 1 = \frac{131072}{5/0.0001} \times 1 = \frac{8192}{3125}$$

◆ Pulse Equivalent of Rotary Axis

The pulse equivalent of rotary axis refers to the rotation degree of the axis clamping the workpiece corresponding to each pulse. The rotated degree of workpiece per revolution of motor is equal to lead screw pitch.

➤ Stepping motor

$$\text{Pulse equivalent} = \frac{360}{\frac{360}{\text{stepping angle}} \times \text{subdivision} \times \text{mechanical deceleration ratio}}$$

➤ Servo motor

$$\text{Electronic gear ratio} \frac{B}{A} = \frac{\text{encoder resolution} \times \text{pulse equivalent}}{360} \times \text{mechanical deceleration ratio}$$

6.2. Stroke Setup of Machine Tool

Machine tool stroke refers to the valid motion stroke of machine tool. In this item, the maximum processing dimensions of the three axes can be set. Because this system regards the machine tool dimensions as the software limit, their value should be consistent with the actual dimensions of machine tool. Otherwise, limit overrun or axis crash may occur.

If the file processing range exceeds the machine tool dimensions, there will be a message box prompting processing is out of range, as shown in Fig. 6-3. You can press [OK] or [ESC] to return to

the main page, and then manually move the machine tool to release limit.

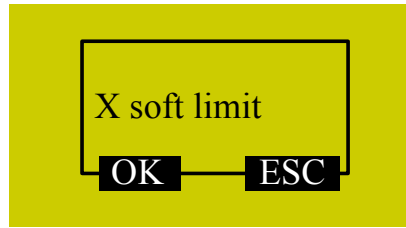

Fig. 6-3 Software limit prompt

Modification to this parameter becomes valid after system reboot.

6.3. Port Polarity

The polarities of input/ output ports in software are specified in terms of the switch type: the polarity of normally closed switch is “P”; the polarity of normally open switch is “N”. The corresponding relation between system port No. and ports on the terminal board is as shown in Table 5 and Table 6.

The method to modify port polarity is as following: press “Menu” key→ select 8. Diagnosis→ select 2. Port List, and then press [OK] key to enter the interface shown in Fig. 6-4. At this time, you can press “Up” or “Down” key to move to the port, and then press “Shift” key to change its polarity. After its polarity change, press [OK] to save the modification.

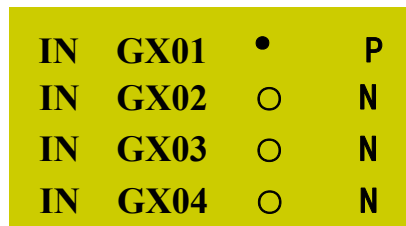

Fig. 6-4 Modification interface of port polarity

Table 5 Corresponding signal of system input ports

System port No.	Terminal name	Corresponding signal	Remark
0	GX01(XORG)	Mechanical origin signal of X axis	External connection with mechanical, photoelectrical and proximity switch
1	GX02(XLM+)	Positive limit signal of X axis	External connection with mechanical, photoelectrical and proximity switch
2	GX03(XLM-)	Negative limit signal of X axis	External connection with mechanical, photoelectrical and proximity switch
3	GX04(YORG)	Mechanical origin signal of Y axis	External connection with mechanical, photoelectrical and proximity switch
4	GX05(YLM+)	Positive limit signal of Y axis	External connection with mechanical, photoelectrical and proximity switch
5	GX06(YLM-)	Negative limit signal of Y axis	External connection with mechanical, photoelectrical and proximity switch

6	GX07(ZORG)	Mechanical origin signal of Z axis	External connection with mechanical, photoelectrical and proximity switch
7	GX08(ZLM+)	Positive limit signal of Z axis	External connection with mechanical, photoelectrical and proximity switch
8	GX09(ZLM-)	Negative limit signal of Z axis	External connection with mechanical, photoelectrical and proximity switch
9	GX10	Extended input 0	
A	GX11	Extended input 1	
B	GX12	Extended input 2	
C	GX13	Extended input 3	
D	GX14	Extended input 4	
E	GX15	E-stop alarm signal input	External connection with E-stop button on the machine tool
F	GX16	Tool presetting signal input	

Table 6 Corresponding signal of system output ports

System port No.	Terminal name	Corresponding signal	Remark
0	GY013(SP-)	Control port of spindle reverse rotation	
1	GY014(SP+)	Control port of spindle forward rotation	
2	GY15(S_2)	Output port of spindle speed gear 2	Control ports of multi-section spindle gears with at most 8 gears of speed control; COM of spindle connected with GND of terminal during wiring
3	GY16(S_1)	Output port of spindle speed gear 1	
4	GY17(S_0)	Output port of spindle speed gear 0	
5	GY18	Output port of workpiece cooling	
6	GY19	Output port of spindle coolant	
7	GY20	Output port of auto lubricating fluid	

6.4. Backing to Mechanical Origin

Origin of Machine Coordinate System (inherent coordinate system of machine tool), also called mechanical origin or mechanical zero, is fixed after design, manufacturing and debugging before machine tool leaving factory. Only after backing to mechanical origin can such operations as enabling software limit, setting fixed point and changing tool be executed. After startup of control system, it is necessary to execute the operation of returning to mechanical origin. This system will remind user to back to mechanical origin after start-up.

If backing to mechanical origin can't be executed due to origin fault, it is necessary to set the parameter "Back REF First" as "No".

6.4.1. Parameter Setup of Backing to Mechanical Origin

Enter menu page before modifying parameters. Parameter of "REF. Point Set" includes "REFP Speed", "REFP Dir" and "Retract Dist".

Press "Menu" key→ select 5. Mfr Param→ select 5. REF. Point Set, and then press [OK] key to enter the setting interface of backing to mechanical origin, in which press "Up" or "Down" key to select the corresponding parameter to be modified.

- "REFP Speed": it is the speed of rough positioning during backing to mechanical origin, i.e. the motion speed of axis towards origin switch during rough positioning. The value of this parameter should be in accordance with the integral structure of machine tool. And too high speed can cause missing steps, and damage to machine tool or origin detector switches by axis crash.
- "REFP Dir": it is the direction of rough positioning during backing to mechanical origin, i.e. the motion direction of axis towards origin switch during rough positioning. This parameter is decided by motor direction and the installation position of returning to origin switch; at the same time, it is related with the defined attribute defined by input level and the attribute of backing to origin detector origin.
- "Retract Dist": this parameter is decided by the machine tool itself. After arriving at the mechanical origin, the machine tool will move some distance away from the origin to get out of the signal sensitive zone of origin switch. Its value is recommended as half of screw pitch.

6.4.2. Operation Mode of Backing to Mechanical Origin

After system start-up, press [OK] key to call all the axes to back to mechanical origin in the dialog box shown in Fig. 6-5.

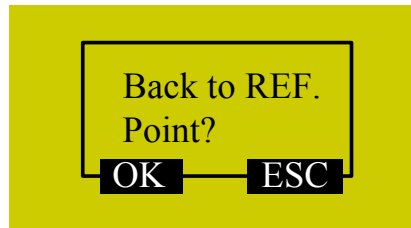

Fig. 6-5 Prompt dialog box of backing to mechanical origin

This method can only call all the axes to back to mechanical origin. If you want to execute backing to mechanical origin of a single axis, you need to enter menu page.

Press “Menu” key→ select 3. Operations→ select 1. Back REF Point, and then press [OK] key to enter setup interface of backing to mechanical origin, in which press “Up” or “Down” key to select the desired mode. Then press [OK] key to execute backing to mechanical origin in the selected way. It is recommended to execute “Z Home” firstly. If “X Home” or “Y Home” is executed firstly, a message shown in Fig. 6-6 will be displayed prompting to execute “Z Home” firstly. To see all the information, press “Up” and “Down” keys.

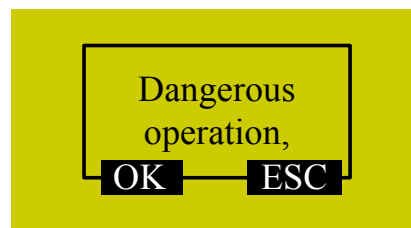

Fig. 6-6 Dangerous prompt for operation of backing to mechanical origin

At this time, you can press [OK] key to enter the processing page and execute backing to mechanical origin for the selected axis, or press [ESC] to cancel and return to the previous interface.

6.5. Spindle Debugging

This system provides the control functions to control spindle motor through parameters of “Spindle Gears”, “ON/OFF Delay”, “Initial Gear” and “Max. Spdl Speed”. Spindle speed can be revised during processing under the condition that the interface board and frequency converter have been well connected.

6.5.1. Spindle Setup

Press “Menu” key→ select 5. Mfr Param→ select 6. Spindle Set, and then press [OK] key to enter spindle setup interface, in which press “Up” or “Down” key to select the corresponding parameter for modification.

◆ Spindle Gears

Currently, the maximum 8-gear is supported.

◆ **ON/OFF Delay**

Since it takes some time for spindle to reach the rated rotary speed or completely stop, tool damage or scrap will occur if machining starts before spindle reaching the rated rotary speed or other actions are performed before spindle stopping completely. This parameter helps user make spindle reach the specified rotate speed when start-up or stop completely in the end

◆ **Initial Gear**

It sets the default gear when spindle starts, and its value should be smaller than the total gear number of spindle. Otherwise, the input value is invalid. If the input value of “Spindle Gears” is smaller than that of “Initial Gear”, the setup is not effective, either.

Modification to this parameter becomes effective after reboot.

◆ **Max. Spdl Speed**

It refers to the maximum allowable rotate speed of spindle; its value is consistent with the setting of transducer.

Modification to this parameter becomes effective after reboot.

6.5.2. Park MCS Site

Press “Menu” key→ select 3. Operations→ select 5. Park MCS Site, and then press [OK] key to enter the interface of “Park Mode” and “Park Site”, as shown in Fig. 6-7. The position of spindle can be set here after machining ends.

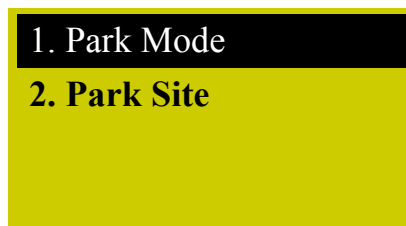

Fig. 6-7 Park MCS site interface

Select “Park Mode”, and then press [OK] key to enter the interface shown in Fig. 6-8.



Fig. 6-8 Park mode selection

Press “Up” or “Down” key to select the desired item, and then press [OK] key to accomplish the selection and return to the previous menu. If “To park site” is selected and confirmed, input or select

the park site under 2. “Park Site”.

After selecting “Select Site”, press [OK] key to enter its setting interface, and then press [OK] again to set current position as park position. System will then back to the main interface automatically. At this time, you can press “Processing Start” key to start machining directly.

Note:

Current position can not be set under “Select Site” interface; you need to set the current position of spindle in advance.

6.5.3. Spindle Stop

Press “Menu” key→ select 4. Oper Param→ select 10. Spindle Stop, and then press [OK] key to enter the setting interface of “Spindle Stop”, in which press “Up” or “Down” key to select the corresponding parameter for modification. Three modes of spindle stop are shown in Fig. 6-9.

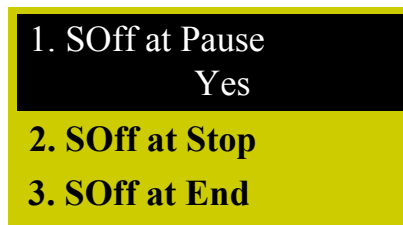

Fig. 6-9 Spindle stop setting interface

7. Menu Page

7.1. Summarization

The default mode after system start-up is manual mode. Processing page is the current page, including coordinate axis, coordinate value, operation state, spindle state, type of manual speed and processing mode, as illustrated in Fig. 7-1.

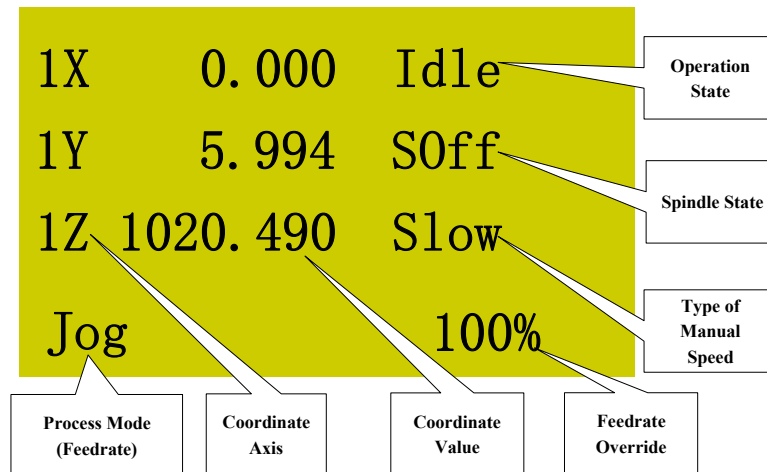



Fig. 7-1 Processing page

Various operation prompts are displayed at the lowest part of processing page.

If E-stop key is pressed during processing, other keys become invalid except “Menu” key; you can press “Menu” key to modify contents.

◆ Coordinate Axis

Coordinate axis is comprised of mechanical coordinate system (MCS) and workpiece coordinate

system (WCS). User can press the combination key  and  to switch between these two coordinate systems. Fig. 7-1 is WCS, and the number 1~6 before X/Y/Z axis indicates the coordinate system from G54 to G59. For MCS, there is no number before X/Y/Z axis. After returning to mechanical origin is accomplished, the sign of * will be displayed after the corresponding axis in MCS.

◆ Process Mode





It is comprised of jog and stepping modes, which can be switched by pressing “Shift” key.

◆ Operation State

Operation state includes idle, E-stop, running, pause and lock states.

◆ Spindle State

It includes spindle gears and spindle stop which can be switched by  5 under idle state.

During processing, press  +  7 or  +  1 to increase or decrease the spindle gear. 1S represents rotate speed of the first gear, 2S rotate speed of the second gear, and nS rotate speed of the nth gear.

◆ Type of Manual Speed

Manual speed can be divided into two types: manual high speed and manual low speed, which can be switched by pressing  0. Please refer to chapter 8.1.1 for the speed setting method.

◆ Menu Page

Press  to enter menu page. There are altogether 8 parameter items in the menu but the LCD can only show 4 of them at a time, as shown in Fig. 7-2.

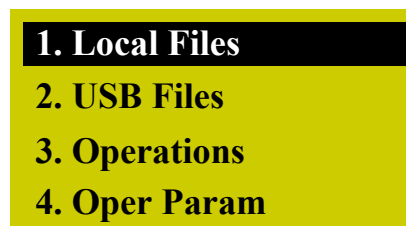



Fig. 7-2 Menu page

Press “Up” and “Down” keys to select the desired item and then press [OK] key to enter the corresponding sub-menu.

7.2. Browse Local Files/Browse USB Files

Its interface is as shown in Fig. 7-3, in which user can load, delete or copy a file. Only a file can be loaded to the system at a time. If several files are selected at the same time, a prompt dialog will appear in loading.

Note:

After  3 is pressed to select “③ Copy”, a dialog box will pop up; press [OK] to start copying; when the file is large, the system interface will display “ Copying...”; please do not press any key on the operation panel at this time and wait patiently.

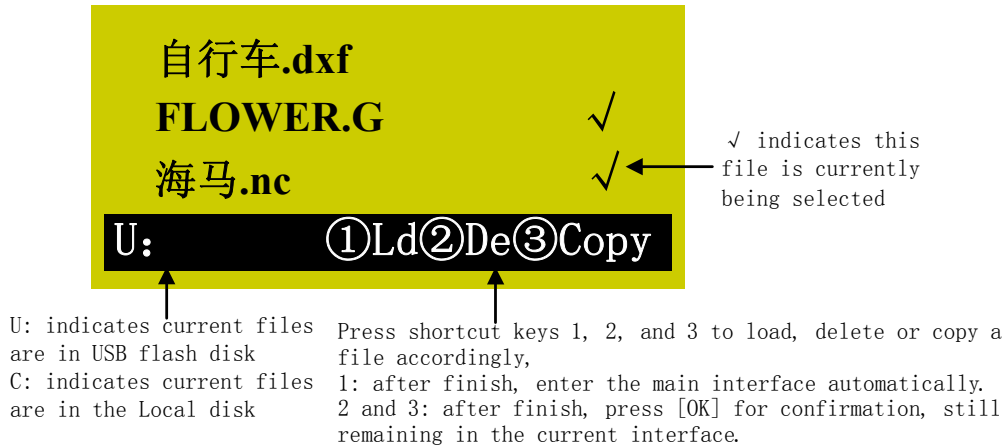

Fig. 7-3 File list interface graphical representation

7.3. Operations

The sub-menus under [Operations] are shown in Fig. 7-4.

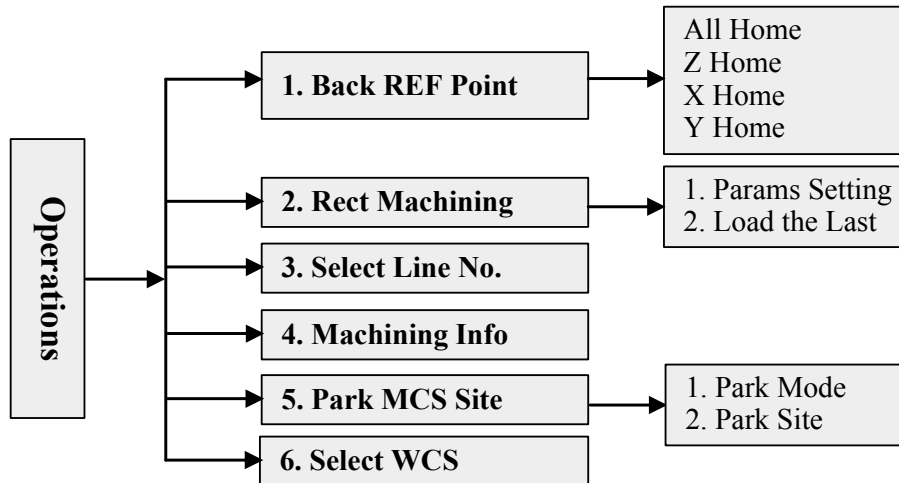

Fig. 7-4 Submenus under [Operations]

Press “Menu” key→ select 3. Operations by pressing “Up” or “Down” key, and then press [OK] key to enter its sub-menus, in which select the desired menu item also by “Up” or “Down” key. The interface is as shown in Fig. 7-5.

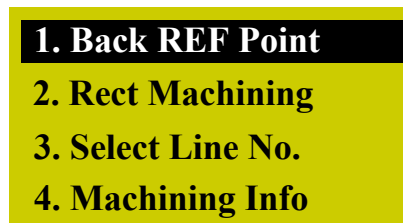

Fig. 7-5 Operations interface

7.3.1. Backing to Mechanical Origin

For the detailed introduction, see chapter 6.4.

7.3.2. Rectangular Plane Processing

The system offers rectangular plane processing; after setting parameters successfully, press “Up” or “Down” key to select [Load Now] and then press [OK] to load the processing file; and then you

can press  to start machining.

Or select “2. Load the Last”, and then press [OK] key for confirmation and return to processing

page; and then press  to start machining.

Parameters of “X Init” and “Y Init” decide the initial position of processing plane; “Height” and “Width” decides the size of processing plane; two kinds of processing mode are available: “Horiz. Mill” (the feed direction of tool is parallel to X axis) and “Long. Mill” (the feed direction of tool is parallel to Y axis); “Each Dpth” is the tool processing depth each time; generally, the value of “Engr Dpth” (the total depth of several millings) is set bigger than that of “Each Dpth”; if the value of “Each Dpth” is equal to or bigger than that of “Engr Dpth”, only one milling will finish processing; “Nose Gap” means the distance between two adjacent lines, whose value should be set smaller than that of Tool Dia” to avoid missing milling.

Note:

1. When the parameter settings are finished and “Load Now” is selected, you still need to press [OK] key to load the processing file.
2. If the input value of “Engr Dpth” is too big, the system will send the warning information “Too many file layers generated, continue?”, as shown in Fig. 7-6. You can press [ESC] to back to modify the value; or press [OK] to load the file forcibly, the system staying in the interface shown in Fig. 7-6. At this time, if you press a key, its function will not be executed until this dialog box disappears, so it is not allowed to press any key under this state. You can wait patiently until the file is loaded, or you can power off and re-power on the system.

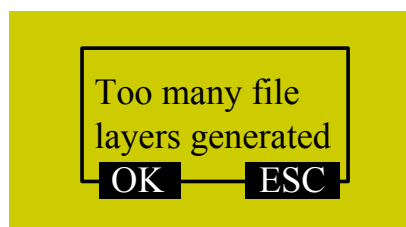

Fig. 7-6 Warning dialog when parameter not properly set

7.3.3. Select Line No.

This interface shows the loaded file information, like total line, start line No. and end line No. The default setting of “Start Line” is the breakpoint position of current file, and “End Line” the last line. With

this function, user can select the module to be processed. After these values are set, press “Up” or “Down” key to select “Execute Now”, and then press [OK] to start machining instantly.

Note:

The default line No. of “Start Line” is the breakpoint line No. under this interface.

7.3.4. Machining Info

After this item is selected and [OK] key is pressed, the system will analyze the file currently loaded automatically, calculating the needed time for file processing and the processing range of each axis. The interface of analytic result is as shown in Fig. 7-7.

Time:	0:	1:	42
X :	108	205	
Y :	20	117	
Z :	0	5	

Fig. 7-7 Analytic result of processing information

7.3.5. Park MCS Site Setup

For the detailed information, refer to Park MCS Site in chapter 6.5 Spindle Debugging.

7.3.6. Select WCS

Press “Menu” key→ select 3. Operations→ select 6. select Select WCS, and then press [OK] key to enter the interface shown in Fig. 7-8, displaying the six workpiece coordinate systems from G54 to G59.

G54 WCS
G55 WCS
G56 WCS
Select by [OK] key

Fig. 7-8 WCS selection interface

After pressing “Up” or “Down” key to select the corresponding WCS, press [OK] key to confirm the selection. After confirmation, the number before X/Y/Z axis may change, WCSs of G54~G59 corresponding to 1~6 accordingly.



7.4. Oper Param (Operator Parameters)

◆ Parameters Related with Velocity

Parameter	Meaning	Setting range
G00 Speed	G00 speed, which can be set in this parameter or in the program file	Related with machine tool G00 speed ≤ the max. velocity of machine tool)
Gxx Speed	Gxx speed	Related with machine tool
Ratio ON Manu	Whether manual operations affected by feedrate override	Yes: affected No: Not affected

The max. velocity of machine tool is related with the setting of pulse equivalent. For the detailed expression, see chapter 6.1.2.

The relation between real feedrate and feedrate override is:
Real feedrate= Feedrate × Feedrate override

The least unit of feedrate override is 0.1, i.e. the override will increase (decrease) 0.1 after each press of  or , and the feedrate override displayed on the screen will increase (decrease) 10.

The adjustment range of feedrate override is 0.0~1.2. When the feedrate is adjusted, the value of feedrate will also change accordingly.

Manual high speed and manual low speed are set under main interface; G00 speed ≥ processing speed, and manual high speed ≥ manual low speed > 0.06

◆ Parameters Related with Processing

Parameter	Meaning	Setting range
Back REF First	Whether to back to mechanical origin forcibly before machining	Yes: must back No: Not forced
Lifts on Pause	Lifting amount on pause	0~10000
Cycle Process		
Cycle Process	Whether to enable cycle process	Yes: enabled No: not enabled
Cycle Times	Cycle processing times, valid when "Cycle Process" is set as "Yes"	1~9999
Cycle Interval	Interval of cycle processing	0~3600000
S_Off in Intev	Whether spindle stops in the interval	Yes: valid No: invalid
G73_G83 Retract	Retracting or spacing amount of G73_G83 command	0~1000000
Ratio ON Manu	Whether manual operations affected by feedrate override	Yes: affected No: Not affected

Backing to mechanical origin before processing can prevent processing deviation, ensuring position accuracy. It is recommended to set “Back REF First” as “Yes” to disable machine tool to run automatically if backing to mechanical origin is not executed before processing. When backing to mechanical origin can not be executed due to origin fault, “Back REF First” can be set as “No”.

G73_G83 Retract: the retract amount after each feed under G73 command; under G83 command, the distance between the point from fast drilling to peck during each descending of tool interrupted feed and the descending point of last cutting feed.

◆ Parameters Related with Offset

Parameter	Meaning	Setting range
Public Offset	Aiming at all the coordinate systems, used for adjusting workpiece origin of X, Y and Z axes	-10000~10000
Work Offset	D-value of WCS origin and MCS origin	-10000~10000

For the detailed information, refer to chapter 4.2.
The relation of workpiece offset, tool offset and public offset is as following:
Workpiece coordinate = Mechanical coordinate - Workpiece offset – Tool offset – Public offset

◆ Spindle Parameters

Parameter	Meaning	Setting range	
Spindle Stop			
SOff at pause	Whether to stop spindle at pause	Yes: stop	No: not stop
SOff at Stop	Whether to stop spindle at stop	Yes: stop	No: not stop
SOff at End	Whether to stop spindle when processing finishes	Yes: stop	No: not stop

This group of parameters sets whether to stop spindle under various forms of stop state.

◆ File Parameters

Parameter	Meaning	Setting range	
Eng Params			
Lifting Height	It sets the tool lifting height of Z axis during rapid traverse of machine tool when an ENG file is being processed.	0~99999	
Tool Change Tip	It sets whether to pause and prompt tool change when tool change command is encountered during ENG file processing.	Yes: valid	No: invalid
Cycle Times	It sets the cycle times to process an Eng file.	0~100000	
Deep Hole Mode	Mode selection for deep hole machining	0: reciprocating chip removal 1: high-speed reciprocating chip removal	

Retract Amount	Retract amount after each feed in high-speed reciprocating chip removal mode	0~99999999
Select Tool No.	If this parameter is set as "Yes", the machining will go on in terms of the specified tool No. in the machining file and only this file will be processed.	Yes: valid No: invalid
Dxf Params		
Lifting Height	It sets the tool lifting height of Z axis during rapid traverse of machine tool when a DXF file is being processed.	0~99999
Process Depth	It specifies the processing depth for 2D files.	-99999~0
1st Point as 0	It sets whether to set the first point as workpiece origin when DXF file is processed.	Yes: valid No: invalid
Shape Process	The system will not process the next shape until the last shape is finished.	Yes: valid No: invalid
Bottom Process	Valve operation is enabled only when [3D cutting] is on the workpiece surface.	Yes: valid No: invalid
Metric Size	It forcibly sets dxf file as metric size.	Yes: metric size No: imperial size
<p>These two groups of parameters are specially aiming at ENG files and DXF files.</p> <p>The system treats each tool lifting as a process step. If several shapes, with each shape including several steps, are to be machined, the second step will not machined until the first step of all the shapes are finished under the condition of the parameter "Shape Process" set as "No".</p> <p>If the parameter "1st Point as 0" is set as "No", the zero coordinate of DXF file will be regarded as workpiece origin in processing; if "Yes", the self-defined point in the DXF file will be treated as workpiece origin. For instance: when drawing a picture with CAD, user can define a point (this point will not be processed) freely in the picture (it's better if the point is near or within the picture); and then the system will treat it as workpiece origin. If there are several points in the DXF file, the system will think the first drawn point as workpiece origin.</p>		

◆ Tool Change Parameters

Parameter	Meaning	Setting range
Tool Change		
ATC Capacity	Capacity of tool magazine	1~20
Current Tool No.	Tool No. currently used	1~value of ATC Capacity
Tool Offset	Modification to the tool offset along each axis	X/Y/Z: -10000~10000
Tool Change Tip	Whether to send prompt when there is tool change command in the file	Yes: valid No: invalid

◆ **Command Ignoring**

Parameter	Meaning	Setting range
Ignore F Code	Whether to use the feedrate command in the program	Yes: use the feedrate in the system No: use the feedrate in the file
Ignore S Code	Whether to use the spindle command in the program	Yes: use the spindle command in the system No: use the spindle command in the file

7.5. Mfr Param (Manufacturer Parameters)

◆ **Velocity Parameters**

Parameter	Meaning	Setting range
Spindle Stop		
Decel. Dist.	To protect tools, the machine tool will decelerate (at [approach speed]) when approaching the target position during positioning. This parameter is used to specify the distance from the decelerating position to the target position.	0~999mm
Approach Speed	It is the feed speed of too when approaching workpiece during positioning (the distance between tool and workpiece is smaller than deceleration distance).	Start speed ~ processing speed
Sgl Axis Acc.	Description of the acceleration/ deceleration capability of each feed axis, with unit "mm/s ² "	0.001~100000.0mm/s ²
Max. Turn Acc.	The max. acceleration of feed motion on adjacent axes	0.001~100000.0 mm/s ²
Jerk	The change rate of acceleration of single axis (acceleration's acceleration)	0.001~100000.0 mm/s ³
Max. Speed of Z	It specifies the max. allowable speed of Z axis.	0.06~100000.0 mm/min
Enbl Plunge Rate	Whether to adopt the plunge cut speed under plunge cut of G01	Yes: valid No: invalid
Z Plunge Cut Spd	The plunge cut speed under plunge cut of G01	0~Max. Speed of Z
Ref Cir Radius	None	0.001~100000.0mm

Ref Cir. Speed	Reference circle is the reference of machine in processing circular workpiece. The max. speed of reference circle refers to the max. allowable speed of machine in processing this circle without strong vibration.	Min. speed of arc processing ~ processing speed
G00 Feed 100%	Whether G00 speed is controlled by override switch	Yes: not controlled by override switch No: controlled by override switch

After installation of machine tool, user can make the machine process an arc, in which vibration will occur due to centrifugal force. The higher the speed is, the stronger the vibration will be. Gradually increase the feed speed to see the state of vibration of machine tool until the max. circular speed is achieved, i.e. the max. allowable speed of machine tool without strong vibration. This arc is regarded as the reference circle, and its max. allowable speed is the max. speed of reference circle. Max. centripetal acceleration “a” can be calculated in terms of the reference circle radius and its max speed. The formula is as follows: V_0 and R_0 are the speed and radius of reference circle respectively, while V_x and R_x are the speed and radius of the arc to be processed. After R_x is confirmed, when the arc processing speed is larger than V_x calculated, the system will limit the arc processing speed automatically to ensure it is within the debugging value, i.e. the vibration will not be stronger than that during ex-factory debugging.

$$a = \frac{V_0^2}{R_0} = \frac{V_x^2}{R_x}$$

◆ **Parameters Related with Machine Tool Debugging**

Parameter	Meaning	Setting range
Axis OutpDir	The motion direction of each axis	Positive; Negative
Machine Stroke	The valid motion stroke of machine tool, i.e. the valid processing range of machine tool along X/Y/Z axis	Set according to the actual machine tool
Pulse Equiv.	The worktable stroke per pulse sent by the CNC device or the rotary degree of rotate axis, i.e. the least distance the CNC system can control	0.00009~999.0mm/p
REF. Point Set		
REFP Speed	The speed of rough positioning in backing to mechanical origin	0.001~max. speed of machine tool
REFP Dir	The direction of rough positioning in backing to mechanical origin	Positive; Negative
Retract Dist	The additional motion distance after fine positioning stage in backing to mechanical origin; positive value moving towards positive direction, negative value towards negative direction	0~10000mm
Sign of BK	Whether to eliminate the sign of backing to	Yes: eliminate

REF	mechanical origin after E-stop	No: Not eliminate
<p>For the detailed introduction of this group of parameters, see chapter 6.1 and chapter 6.2.</p> <p>If user can ensure that the axis position will not move in E-stop, he can set the parameter "Sign of BK REF" as "No", so user can continue processing without backing to mechanical origin after E-stop is obviated. Otherwise, user needs to set this parameter as "Yes" to ensure processing accuracy.</p>		

◆ Spindle Parameters

Parameter	Meaning	Setting range
Spindle Set		
Spindle Gears	Spindle speed is divided into several gears.	1~8
ON/OFF Delay	The waiting time for spindle to reach normal rotary speed after started and stop completely after closed	0~60000 ms
Initial Gear	Initial speed gear	1~spindle gears
Max. Spdl Speed	Max. speed spindle can reach	Spindle speed~999999
Park MCS Site (belongs to Operations)		
Park Mode	The spindle action after processing finishes	Not move (keep still) To park site To WCS origin
Park Site	This parameter is valid when "Park Mode" is set as "To Park Site". Park site can be input manually or selected directly in processing page. For the operation method to select park site, see Menu Page.	Input Site Select Site
For these two groups of parameters, see chapter 6.5.		

◆ Y as Rotary Axis

Parameter	Meaning	Setting range
Y as Rotary Axis	Whether Y axis is set as CNC turntable	Yes: valid No: invalid
Rotary Y Pulse	The pulse equivalent of Y axis when it is set as rotary axis	0~100mm/p
mm as Unit	It sets the measure unit for the rotary axis.	Yes: set the unit as mm No: set the unit as deg
Rev. Work Radius	The length of Y axis in CAM programming is the value of workpiece radius $\times 2 \times \pi$. The value of this parameter changes with workpiece radius processed each time.	0~1000000mm
Rotary Takeoff	The takeoff speed of rotary axis	0~1000000mm/s
Rotary Y Acc.	The acceleration of rotary axis, with unit as rad/s ²	0.001~100000.0 rad/s ²
Max. Rotary Vel.	Max. rotary speed	0.06~6000000 r/min

◆ Lubrication Setting

Parameter	Meaning	Setting range
Lube		
Enable Auto Lube	Whether to open lubrication pump automatically at fixed period	Yes: valid No: invalid
Time Interval	Time interval to open lubrication pump after machine tool start-up	0~34560000s
Duration	Time to release lubrication oil each time	0~34560000s

◆ Parameters Related with Algorithm

Parameter	Meaning	Setting range
Enable S Algo	Whether to adopt acceleration/deceleration of S-type algorithm	Yes: valid No: invalid
Arc Increment	Whether to adopt arc increment mode	Yes: valid No: invalid
Forward Look Seg	Used to set the max. forward looking segments when calculating connection speed	0~10000

In arc increment mode, the coordinate of circle centre is relative to the starting point. Otherwise, it is relative to workpiece origin.

◆ Compensation Parameters

Parameter	Meaning	Setting range
Backlash Set		
Compensation ON	Whether to enable backlash compensation	Yes: valid No: not execute backlash compensation
Axis Backlash	The backlash compensation amount of X, Y and Z axes, valid only when "Compensation On" is set "Yes"	0~1000000mm

Generally, spindle is fixed on the lead screw whose outer wire and the inner wire on the outer wire can not be completely matched, backlash compensation compensates the clearance between the lead screw of last direction that the spindle needs to finish after reversing its moving direction.

7.6. Param Upkeep (Parameter Maintenance)

Press “Menu” key→ select 6. Param Upkeep by pressing “Up” or “Down” key, and then press [OK] key to enter its interface, in which select a submenu by pressing “Up” or “Down” key.

The submenus under this interface are as shown in Fig. 7-9.

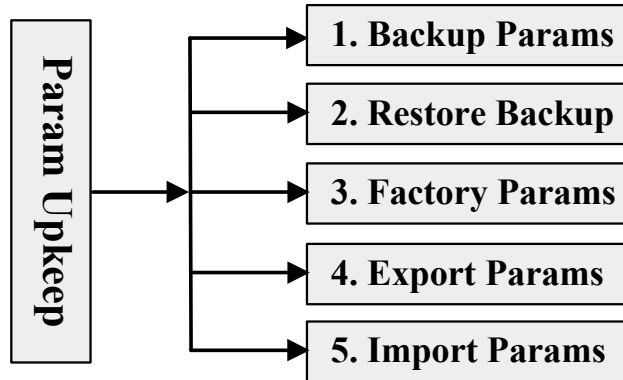

Fig. 7-9 Submenu list of parameter upkeep

7.6.1. Backup Parameters

Press [OK] key to confirm backing up the parameter. No matter the parameter backup is successful or failed, a prompt will be displayed.

7.6.2. Restore Parameter Backups

It is used to restore the backup parameters. If the parameter has not been backed up, “Backup File Not Found!” will be displayed.

If the recovery is successful, a prompt of rebooting system will be displayed, as shown in Fig. 7-10. At this time, you can press [OK] key to reboot the system directly, or [ESC] to return to the previous menu.

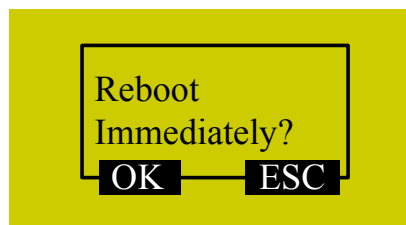

Fig. 7-10 Prompt dialog of system reboot

7.6.3. Restore Factory Parameters

The action of ex-factory parameter recovery is to clear all the data and parameters interiorly set stored in system memory chip. It is necessary to perform this action when there are messy codes in

the interior file or after upgrade finishes.

Operate following the prompts displayed on the screen. After recovery is successful, a cue to reboot the system will be displayed on the screen, as shown in Fig. 7-10. At this time, you can press [OK] to restart the system, or [ESC] to back to the previous menu.

The action of ex-factory parameter recovery won't clear the parameters backup file. Therefore, if this action is carried out accidentally and all the interior parameters are cleared, you can restore the backup parameters by "Restore Backup".

Note:

Modification to this item will not become effective until the system is rebooted.

7.6.4. Export Parameters

When software or hardware fault occurs, you can export parameters to the USB flash disk for backup.

7.6.5. Import Parameters

Import the parameters in the USB flash disk to the system, avoiding repeatedly setting parameters. After import is successful, the system will display a prompt of system reboot as shown in Fig. 7-11.

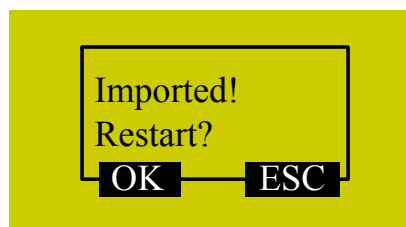

Fig. 7-11 Prompt dialog of successful parameter import

7.7. System Upkeep

Press "Menu" key→ select 7. System Upkeep by pressing "Up" or "Down" key, and then press [OK] key to enter its interface, in which select a submenu by pressing "Up" or "Down" key.

The submenus under this interface are as shown in Fig. 7-12.

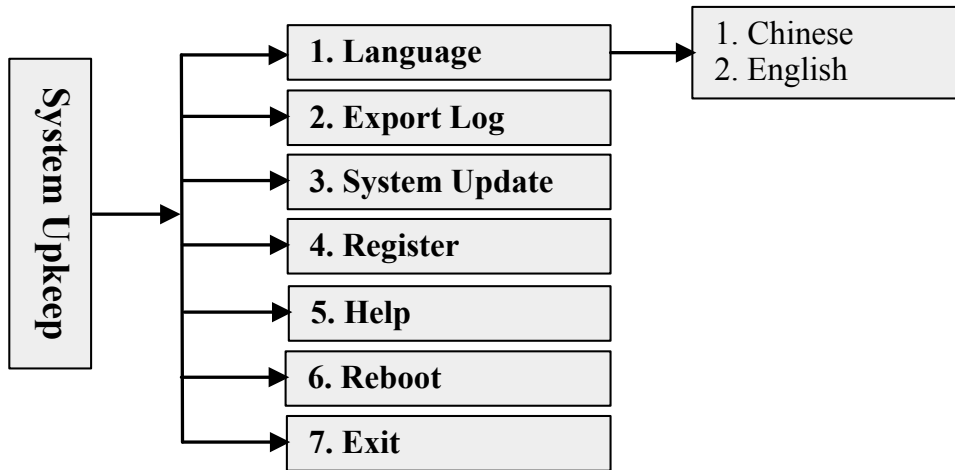

Fig. 7-12 Submenu list of system upkeep

7.7.1. Language

Currently, the system supports two kinds of language: Chinese and English, which can be switched in the following interface.



Fig. 7-13 Chinese-English selection interface

7.7.2. Export Log

A Log.txt will be generated after the log is exported to the USB flash disk. After log export finishes, “Log Exported Successfully” will be displayed on the screen. Press [OK] key or [ESC] key to return to the previous menu.

7.7.3. System Update

After the cursor is on the “System Update” item, press [OK] key for confirmation, after which a dialog will pop up asking whether to update the system. After pressing [OK] key again, a dialog as shown in Fig. 7-14 will pop up.



Fig. 7-14 Prompt dialog after successful system update

Press [OK] key to reboot the system. After the system displays “USB Available Now”, press [OK] key to enter the system update interface, as shown in Fig. 7-15.

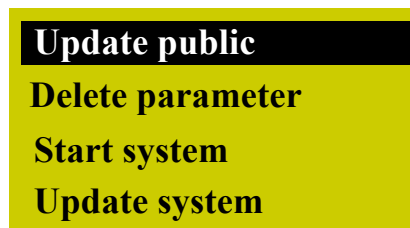

Fig. 7-15 System update page

Select a corresponding operation in this page by pressing “Up” or “Down” key. “Update public” is to update the Public.dat file; “Delete parameter” is to delete the configuration file in BOOT, which must be executed before “Update system”; “Start system” is to start the original system without upgrading it; “Update system” means deleting the original system and upgrading the system by the new application file in the USB flash disk. Please refer to chapter 3.2.3 for the operation of system update.

At this time, you can select “Start system” and then press [OK] key to exit from system update page, or select “Update system” and then press [OK] key to exit from system update page and enter the processing page by booting the new system.

◆ Export Backup

The software will be exported to the USB flash disk for backup, with its backup folder named “backup”.

◆ Import Parameters

This menu item is used to import the parameter file (file name: settings.dat) in the USB flash disk into the system. Generally, the parameter file is under the root directory of the USB flash disk. If it is not in the root directory, search for it in the “backup” folder.

7.7.4. Register

Move the cursor on this item “4. Register”, and then press [OK] key to enter registration code input page, as shown in Fig. 7-16.

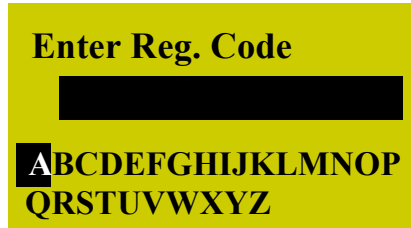



Fig. 7-16 Registration code input interface

Register by entering the registration code in this interface. Select a letter (end-around) by pressing “Up” and “Down” keys, and then press [OK] key for conformation; for the input of figure,

enter a figure by pressing the corresponding key. If the input is wrong, press  to backspace, and then input the right letter or figure.

7.7.5. Help

After the cursor is on the item “5. Help”, press [OK] key to enter “Help Message Show Delay” parameter setting interface as shown in Fig. 7-17. The value of this parameter is integer within the range of 1~999999.

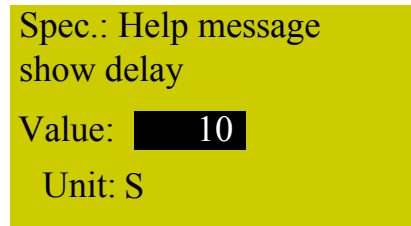



Fig. 7-17 Help setting interface

◆ Specification:

The system offers help function, introducing operation methods under such interfaces as

“Processing page” and “Port list”, in which pressing  +  will enter the corresponding help interface. Or, the system will enter the corresponding help interface itself after a certain time set under the interface shown in Fig. 7-17, when the system is under idle state.

7.7.6. Reboot

After the cursor is on this item, press [OK] key to eject its dialog box, in which press [OK] key to reboot the system.

Or you can keep pressing [ESC] key for about 3 seconds in the main interface to eject the following interface.

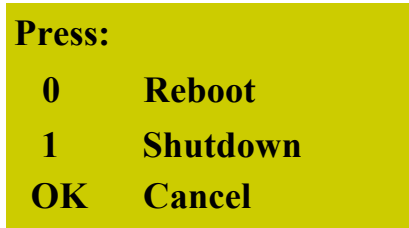

Fig. 7-18 Reboot system interface

Execute the corresponding operation according to the prompt on the screen.

7.7.7. Exit

After the cursor is on this item, press [OK] key to eject a dialog box, in which pressing [OK] key will exit from the system. And then the system goes blank. If you want to enter the system again, you need to power off and re-power the system. In addition, you can also exit from the system by pressing “1” in the interface shown in Fig. 7-18.

7.8. Diagnosis

Press “Menu” key→ select 8. Diagnosis by pressing “Up” or “Down” key, and then press [OK] key to enter its interface, in which select a submenu by pressing “Up” or “Down” key.

The submenus under this interface are as shown in Fig. 7-19.

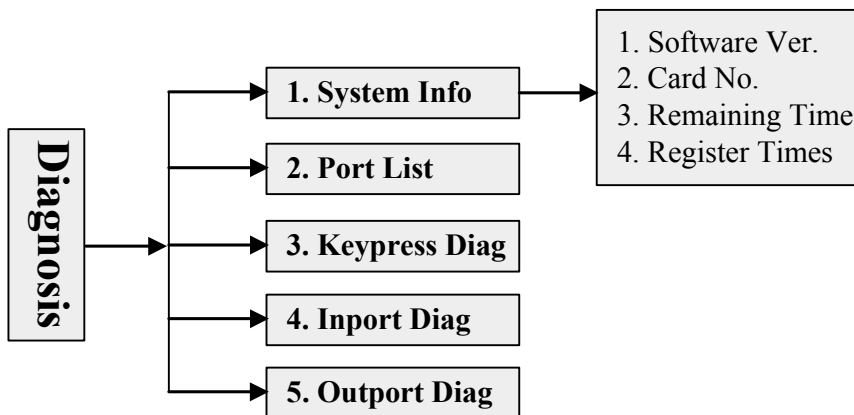

Fig. 7-19 Submenu list of system diagnosis

7.8.1. System Info

In this page, you can view system software version, control card No., remaining time and registered times. If an item is wrong, after pressing [OK] key for confirming selection, an error prompt “Failed to Read Registration Info” will be displayed. At the same time, the other items can not read, either.

7.8.2. Ports List

For the detailed introduction, see chapter 6.3.

7.8.3. Keypress Diag (Diagnosis)

This item is used to check whether keys can be used normally. After entering, the system will

display a prompt “press a key”. Press any key (except ) to show the name of the pressed key on the screen, as shown in Fig. 7-20. If the pressed key is damaged and out of work, the screen will not display its name or the wrong key name.

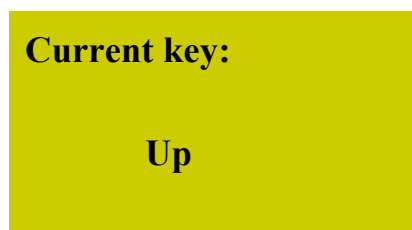



Fig. 7-20 Keypress diagnosis interface

Pressing  will exit from this page.

7.8.4. Inport Diag (Diagnosis)

This interface displays the polarities of the input ports, which can not be changed.

7.8.5. Output Diag (Diagnosis)

This interface displays the polarities of output ports with water lamp display, which can not be modified. The corresponding relation among system output terminal No., terminal board ports and signals is listed in chapter 6.3 “Port Polarity”.

8. Processing Operations

Processing operations can be divided into two categories: manual processing and automatic processing. Processing parameters and machining process can be adjusted conveniently in both manual processing and automatic processing.

8.1. Manual Processing

Manual processing refers to manipulating the machine tool directly by the direction buttons of the three axes on the panel. At the same time, the operation speed and step length, etc. can be adjusted during operation according to the requirements of operation.

After backing to the reference point, the system will enter into manual state; screen display is as shown in Fig. 8-1.

1X	0.000	Idle
1Y	0.000	SOff
1Z	0.000	Slow
Jog		100%

Fig. 8-1 Manual processing interface

8.1.1. Mode Selection of Manual Processing

To satisfy the requirements of manual motion under different situations, this system provides two kinds of manual motion modes: “Jog” and “Stepping”, which can be switched by pressing “Shift” key. User can view the current motion mode through “processing mode” at the bottom of the screen.

◆ Jog Motion Mode



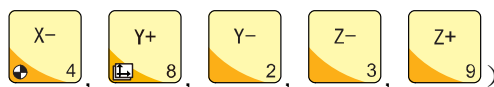



There is no concrete data control under this mode. You can press a motion direction key ( 6),



to move the machine tool accordingly under this mode. The machine tool will not stop until the direction key is released. For the motion speed, it is decided by the current type of speed (manual high speed and manual low speed). This motion mode is suitable for coarse tuning of the position of mechanical coordinate.

◆ Stepping Motion Mode

Under this motion mode, the machine tool will move accordingly after you press a motion

direction key (, , , , , ). For the setup of step, refer to chapter

8.1.2. This motion mode is suitable for fine tuning of the position of mechanical coordinate.

8.1.2. Parameter Setting of Manual Processing

Basic parameters of manual processing include: manual high speed (i.e. “High” shown in the processing page), manual low speed (i.e. “Slow” shown in the processing page), X\Y step and Z step.

Parameter	Meaning	Setting range
MSpd (High)	Two types of speed under manual processing, deciding the axis motion speed during manual processing	0.06~max. speed of machine tool
MSpd (Slow)		0.06~manual high speed
Step XYZ	The motion distance of the corresponding axis when a direction key of X\Y\Z is pressed once	0.001~10000mm

The max. speed of machine tool is related with the setting of pulse equivalent. For the concrete expression, see chapter 6.1.2.

Manual high speed and manual low speed can be switched by pressing .

The concept of stepping (also called as gridding in some other systems) is introduced for the purpose of processing and debugging accuracy. When stepping is current manual motion mode, the step is the motion distance of the corresponding axis when a direction key of X\Y\Z is pressed once.

Under main interface, press [OK] key to enter parameter setting interface of manual processing, as shown in Fig. 8-2.

MSpd	3000/1500
StepXY	10.000
StepZ	1.000
File	<No File>

Fig. 8-2 Manual parameter setting interface

Press “Up” or “Down” key to select the desired parameter, and then press [OK] for confirmation after modification. Note that modification should be within parameter range.

Current file name is displayed at the bottom line. Press “Up” or “Down” key to move the cursor to this line, and then press [OK] key to enter the file list of C disk, as shown in Fig. 8-3. Under this interface, you can only load these files, unable to delete or copy them.





Fig. 8-3 File list interface

If there is no file in C disk, prompt “File Not Found, Show USB File?” will be displayed; press [OK] key to enter the file list of USB flash disk.

To switch between USB file list and C file list, press .

8.1.3. WCS Selection

WCS and MCS can be switched by pressing the combination key  + . And their screen display is as shown in Fig. 8-4.

X	0.000	Idle
Y	0.000	SOff
Z	0.000	Slow
Jog		100%

MCS

1X	0.000	Idle
1Y	0.000	SOff
1Z	0.000	Slow
Jog		100%

WCS

Fig. 8-4 Screen display of WCS and MCS

Number 1~6 in front of X\Y\Z in WCS indicates its corresponding WCS (G54~G59), while there is no number before X\Y\Z in MCS. A sign of * will appear after each axis in MCS after backing to mechanical origin has been finished.

Press “Menu” key→ select 3. Operations→ select 6. Select WCS, and then press [OK] key to enter its interface, in which press “Up” and “Down” keys to select the desired WCS. After selection, the main interface may change a litter. For instance, after selecting G55 WCS, the main interface is as shown in Fig. 8-5.

2X	0.000	Idle
2Y	0.000	SOff
2Z	0.000	Slow
Jog		100%

Fig. 8-5 Main interface under G55 WCS

8.2. Automatic Processing

Automatic processing refers to that the system processes system files and the files in the USB flash disk in terms of instructions, also called file processing. All the parameters of machine tool and system should be set correctly before automatic processing starts.

8.2.1. Load Files

◆ Load an Ordinary File

Press “Menu” key to enter menu page→ press “Up” and “Down” keys to select “Local Files” or “USB Files”→ press [OK] key to enter the corresponding file list interface→ press [OK] key to select

the processing file to be machined→ press  to load the selected file

◆ Load an ENG File with Tool Selection Function

Enter the file list according to the method to load an ordinary file, and then press [OK] key to select the ENG file to be machined, and then press  to enter tool selection interface automatically as shown in Fig. 8-6.

Number of tools: 2
Tool No.: 0
Cutter 1: [Flat Bottom]JD-6.00

Fig. 8-6 Tool selection interface

Number of tools: the number of tools in this ENG file

Tool No.: current tool No., selected by pressing “Up” and “Down” keys

Cutter: selected by pressing “Up” and “Down” keys, displaying tool sequence number and name



After parameters are set, press [OK] key to load the file; after loading, the system will return to processing page automatically.



8.2.2. Confirm Workpiece Origin

The workpiece origin is the origin of workpiece coordinate system (X, Y, Z) in processing program. The actual position of the workpiece origin should be confirmed before processing.

Manually move X and Y axes to the desired origin position, and then press  for zero clearing. Thus, the workpiece origin along X and Y axes is confirmed.

For workpiece origin along Z axis, there are two ways to set it:

- Method one is the same as that to set workpiece origin along X and Y axes. Manually move Z axis to the desired origin position. And then press  +  for zero clearing. Thus, the workpiece origin along Z axis is set.

- Method two takes advantages of tool presetting function (press  + ). After tool presetting finishes, the coordinate of Z axis is the workpiece origin along Z axis.



8.2.3. Start Processing

Press the start key  to start automatic machining in the processing page.

Prompts like feedrate override and feed rate are scrolled on the screen during file processing.



8.3. Adjustment during Automatic Processing

◆ Feedrate Override Adjustment

Feedrate override can be adjusted by pressing  or  during file processing. And the feed rate changes with the feedrate override. The relation between actual feed rate and feedrate override is as follows:

$$\text{Actual feed rate} = \text{Feed rate} \times \text{Feedrate override}$$

The least unit of feedrate override is 0.1. Namely, override increases (decreases) 0.1 after each

press of  or ; at the same time, the screen displays the feedrate override increases (decreases) 10 (%). The range of feedrate override is 0.0 ~ 1.2. In addition, the display of feed rate

value changes with the feedrate override.

◆ **Spindle Speed Adjustment**

Press + or + to adjust the spindle speed, which is divided into 8

gears from S0~S7 with speed increasing sequentially.

◆ **Suspend Processing and Jiggle**

Suspend processing by pressing during processing, running status at the top right corner of the screen displaying “Pause”; at the same time, the machine tool stops; as for spindle, whether it stops or not is decided by the setting of parameter “SOff at Pause”, see chapter 6.5.3 for details. Whether spindle stops or not, at this time, the three axes can be jiggled, and the system default state is “Stepping” mode. Each press of a direction key will make the corresponding axis move a specified step.

◆ **Continue Processing after Pause**

When the system is in the state of pause, pressing the start key will continue processing from the pause position, running status at the top right corner of the screen changing from “Pause” to “Run”; at the same time, the machine tool starts machining.

◆ **Software Limit Treatment**

Software limit occurs when a processing axis exceeds the setting of “Machine Stroke” during processing, and the system will display a limit dialog as shown in Fig. 8-7.

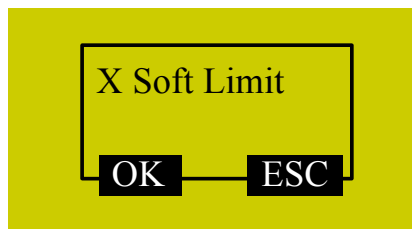

Fig. 8-7 Software limit dialog

Press [OK] or [ESC] to exit from this warning dialog and enter processing page, and then manually move the axis reaching software limit towards the reverse direction to release limit. After software limit occurs, the system prohibits the limit axis from moving towards limit direction.

◆ **Hardware Limit Treatment**

The system detects hardware limit periodically under the main interface. When hardware limit occurs, its prompt dialog is as shown in Fig. 8-8.

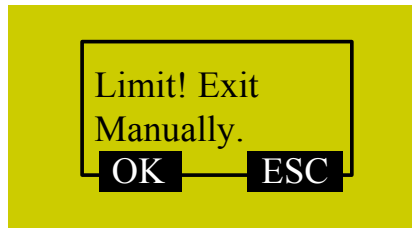

Fig. 8-8 Hardware limit dialog

At this time, press [Ok] key to make the system return to the main interface under “Jog” mode, with “Limit Rls.” displayed at its bottom right corner, as shown in Fig. 8-9. Or you can press [ESC] key to directly back to the main interface under “Jog” mode.

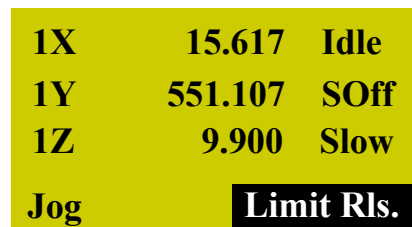

Fig. 8-9 Prompt interface of limit release

Move the machine tool away from the limit position, “Limit Rls.” disappearing; the prompt interface of limit release backs to the normal main interface.

9. Function Information of Double-cylinder & Double-transducer

When a NK105G2 is equipped with double-cylinder & double-transducer function, its differences in ports and functions are listed in the following, while its other functions are the same as those of a general NK105.

9.1. Ports

Table 7 Signal details of output ports

Silk-printed name	Signal	Remarks
GY013 (SP-)	Spindle 2	For connection with ON/OFF signals of transducer
GY014 (SP+)	Spindle 1	For connection with ON/OFF signals of transducer
GY18	Cylinder 1	Optical-coupler output
GY19	Cylinder 2	Optical-coupler output

9.2. Related Parameters

◆ Upper Position of Tool Change

Location: Menu→ 4. Oper Param→ 14. Tool Change→ 5. CTUpPosition; Unit: mm; Default value: -1.000;

Function: to guard against breaking edge phenomenon during the change-over between two cylinders, the Z axis moves up a certain height before a new cylinder is opened.

◆ Tool X (1, 2.....)

Location: Menu→ 4. Oper Param→ 14. Tool Change→ 3. Tool Offset→ 1. Tool 1 (2. Tool 2);
Unit: mm; Default Value: 0;

Function: it sets the offset between two tools to ensure that the two tools are on the same datum point during machining.

9.3. Programming Instructions

T1: cylinder 1 is opened

T2: cylinder 2 is opened

M101: spindle 1 is opened

M102: spindle 1 is closed

M201: spindle 2 is opened

M202: spindle 2 is closed

9.4. Programming Example

T1 (cylinder 1 is opened, while cylinder 2 is closed)

M101 (spindle 1 is opened)

```
G00 X10 Y10 Z0
G01 X10 Y10 Z-5
G01 X110 Y10 Z-5
G01 X110 Y110 Z-5
G01 X10 Y110 Z-5
G01 X10 Y10 Z-5
G00 Z10
G00 X10 Y10
```

M102 (spindle 1 is closed)

T02 (cylinder 2 is opened, while cylinder 1 is closed)





M201 (spindle 2 is closed)

```
G00 X11 Y11 Z-5
G01 X109 Y11 Z-5
G01 X109 Y109 Z-5
G01 X11 Y109 Z-5
G01 X11 Y11 Z-5
G00 Z10
```

M202 (spindle 2 is closed)

M5

9.5. Keypresses

Key icon	Function
 + 	Measuring tool length
 + 	setting tool length

+	Floating presetting
+	Cylinder 1 is opened
+	Cylinder 2 is opened

◆ **Remarks:**

➤ Tool No. is displayed after “Jog” in the processing interface.

➤ By pressing + several times, cycle is opened, cylinder 1 is closed, and tool No. 1 is displayed; by pressing + several times, cycle is opened, cylinder 2 is closed, and tool No. 2 is displayed.



➤ Pressing will start the corresponding spindle according to the current tool No.. For example, if tool No. 1 is the current tool, by pressing , spindle 1 is started; if tool No. 2 is the current tool, spindle 2 is opened.

9.6. Operating Instructions



◆ **Operating Instructions with a Tool Presetter**

The first step is to measure the tool length. Under Jog mode, pressing + will open cylinder 1. Put the tool presetter under the tool, and then press + . At this time, the Z axis will move downwards slowly until touching the presetter, and then it will move up a little distance, “Measure tool length successfully” displayed. Pressing [OK] key will successfully set cylinder 1 by the system automatically recording the current tool length into Z offset of current tool No.. Switch to cylinder 2, then press + to close cylinder 1 automatically, move up the Z axis to upper

position of tool change (refer to parameter “CTUpPosition”) and open cylinder 2. Put the tool presetter



under the tool, and then press  + . At this time, the Z axis will move downwards slowly until touching the tool presetter, and then it will move up a little distance, “measure tool length successfully” displayed. Pressing [OK] key will successfully set cylinder 2 by the system automatically recording the current tool length into Z offset of current tool No.. Up to now, the length offsets of two tools have been set successfully. The system will then call different offsets according to the corresponding tool No. to make machining in the same plane.



The second step is to fix workpiece origin. Open a cylinder, put the tool presetter under the tool



(no matter which tool No.), and then press  + . At this time, the Z axis will move downwards slowly until touching the tool presetter, and then it will move up to a point, “tool presetting finished” prompted. Pressing [OK] key will set the point as workpiece origin of Z axis automatically.



The third step is to start machining automatically by pressing . After machining finishes, it is necessary to only perform the second step and the third step again without performing the first step on condition that only a new workpiece is replaced with no change of the tool.

◆ Operating Instructions with No Tool Presetter

The first step is to set the tool length. Under Jog mode, pressing  +  will open cylinder 1. Manually adjust the Z axis to make its knife point touch the workpiece surface, and then

press  + , “set tool length successfully” displayed. Pressing [OK] key will set cylinder 1 successfully by the system automatically recording the current tool length into Z offset of current tool

No.. Switch to cylinder 2, then press  +  to close cylinder 1 automatically, move up the Z axis to upper position of tool change (refer to parameter “CTUpPosition”) and open cylinder 2. Manually adjust the Z axis to make its knife point touch the workpiece surface, and then press

 + , “set tool length successfully” displayed. Pressing [OK] key will set cylinder 2 successfully by the system automatically recording the current tool length into Z offset of current tool No.. Up to now, the length offsets of two tools have been set successfully. The system will then call

different offsets according to the corresponding tool No. to make machining in the same plane.

The second step is to fix workpiece origin. After X origin and Y origin are input, pressing  will set X and Y workpiece origins successfully. For any tool No., open a cylinder, manually adjust the

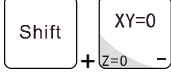
Z axis to make its knifepoint touch the workpiece surface, and then press . The Z workpiece origin is fixed successfully.

The third step is to start machining automatically by pressing . After machining finishes, it is necessary to only perform the second step and the third step again without performing the first step on condition that only a new workpiece is replaced with no change of the tool.

9.7. Motion Process during Machining

During machining, in case of meeting T1 command, the system will move the Z axis to upper position of tool change, open cylinder 1, change current tool No. to 1, and call the position offset of Tool 1; in case of meeting M101 command, the system will open spindle 1 for machining; in case of meeting M102 command, the system will close spindle 1; in case of meeting T2 command, the system will close cylinder 1, move the Z axis to upper position of tool change, open cylinder 2, change the current tool No. to 2, and call the position offset of Tool 2; in case of meeting M201 command, the system will open spindle 2 for machining; after machining finishes, the system will close the current cylinder and spindle.

10. Function Information of Three-cylinder & Single-transducer

When a NK105G2 is equipped with three-cylinder & single-transducer function, its differences in ports and functions are listed in the following, while its other functions are the same as those of a general NK105.

10.1.Ports

Table 8 Signal details of output ports

Silk-printed name	Signal	Remarks
GY014 (SP+)	Spindle	For connection with ON/OFF signals of transducer
GY18	Cylinder 1	Optical-coupler output
GY19	Cylinder 2	Optical-coupler output
GY20	Cylinder 3	Optical-coupler output

10.2.Related Parameters

◆ Upper Position of Tool Change

Location: Menu→ 4. Oper Param→ 14. Tool Change→ 5. CTUpPosition; Unit: mm; Default value: -1.000;

Function: to guard against breaking edge phenomenon during the change-over between two cylinders, the Z axis moves up a certain height before a new cylinder is opened.

◆ Tool Change Delay

Location: Menu→ 4. Oper Param→ 14. Tool Change→ 6. CTDelay; Unit: ms; Default value: 0ms;

Function: to avoid transducer alarm during change-over of cylinders; generally within 2~5.

◆ Tool X (1, 2.....)

Location: Menu→ 4. Oper Param→ 14. Tool Change→ 3. Tool Offset→ 1. Tool 1 (2. Tool 2);

Unit: mm; Default Value: 0;

Function: sets the offset between two tools to ensure that the two tools are on the same datum point during machining.

10.3.Programming Instructions

T1: cylinder 1 is opened

T2: cylinder 2 is opened

T3: cylinder 3 is opened

10.4. Programming Example

T1 (cylinder 1 is opened, while cylinder 2 and cylinder 3 are closed)

```
G00 X10 Y10 Z0
G01 X10 Y10 Z-5
G01 X110 Y10 Z-5
G01 X110 Y110 Z-5
G01 X10 Y110 Z-5
G01 X10 Y10 Z-5
G00 Z10
G00 X10 Y10
```













T2 (cylinder 2 is opened, while cylinder 1 and cylinder 3 are closed)

```
G00 X11 Y11 Z-5
G01 X109 Y11 Z-5
G01 X109 Y109 Z-5
G01 X11 Y109 Z-5
G01 X11 Y11 Z-5
G00 Z10
```

T3 (cylinder 3 is opened, while cylinder 1 and cylinder 2 are closed)

```
G00 X10 Y10 Z0
G01 X10 Y10 Z-5
G01 X110 Y10 Z-5
G01 X110 Y110 Z-5
G01 X10 Y110 Z-5
G01 X10 Y10 Z-5
G00 Z10
G00 X10 Y10
M5
```

10.5. Keypresses

Key icon	Function
 + 	Floating presetting
 + 	Setting tool length
 + 	Measuring tool length
 + 	Opening and closing of cylinder 1
 + 	Opening and closing of cylinder 2
 + 	Opening and closing of cylinder 3

10.6. Operating Instructions

For the concrete operations, refer to Chapter 9.6.

10.7. Motion Process

During machining, in case of meeting T1 command, the system will move the Z axis to upper position of tool change, close cylinder 2 and cylinder 3, move the Z axis to upper position of tool change, open cylinder 1, change current tool No. to 1, and call the position offset of tool 1 for machining; in case of meeting T2 command, the system will close cylinder 1 and cylinder 3, move Z axis to upper position of tool change, open cylinder 2, change current tool No. to 2, and call the position offset of tool 2 for machining; in case of meeting T3 command, the system will move the Z axis to upper position of tool change, close cylinder 1 and cylinder 2, move the Z axis to upper position of tool change, open cylinder 3, change current tool No. to 3, and call the position offset of tool 3 for machining; after machining finishes, the system will close the current cylinder and spindle.

11. Driver

11.1.Driver parameters

Parameters description of drivers listed in this chapter can only make the machine tool motion normally, without ensuring machining effects. To ensure machining effects, related parameters need adjusting according to the specific machine tool.

11.1.1. Parameter Setting of YASKAWA Σ -II Servo Driver

Para. No.	Function	Value	Description
Fn010	Set password (to prevent arbitrarily modification to parameters)	0000	Set [0000]: modification to user parameters [PnXXX] and part of auxiliary function parameters [FnXXX] permitted; Set [0001]: modification to user parameters [PnXXX] and part of auxiliary function parameters [FnXXX] prohibited.
Un00C	Pulse counter of input command	LXXXX (Hexadecimal system)	Monitor if the number of sent and received pulse is correct by setting this parameter. In Weihong control system, the correct quantity of pulse sent by control card is detected by pulse inspection in order to determine whether there is electrical interference.
Pn000	Direction selection Control mode selection	0010	Bit 0: Set 0, "CCW" is forward rotation (viewed from the load end of screw ball); Set 1, the rotation direction of the motor is reversed. Bit 1: Set 1, position control mode (calculate pulse instruction all the time).
Pn200	Select pulse instruction mode	0005	Bit 0: Set 5, select the instruction input mode as "pulse + direction", negative logic. Bit 3: Set 0, input differential signal into filter.
Pn50A	Selection function	8100	Bit 1: Set 0, Servo ON /S-ON, input from 40th pin; Set 7, Servo ON all the time. Bit 3: Set 8, positive rotation not used and signal input (P-OT) prohibited.
Pn50B	Selection function	6548	Bit 0: Set 8, reverse rotation not used and signal input (N-OT) prohibited.
Pn50F	Selection function	0300	Set it when servo motor with brakes. Bit 2: Set 3, brake interlock signal "/BK" is output from CN1-29, CN1-30 to control 24V relay for brake

Pn50E	Selection function	0211	Set it when servo motor with brakes To avoid of CN1-29 and CN1-30 being used for other function and leading to brake ineffective, "3" is not allowed to appear in the 4 digits.		
Pn506	Servo off, time delay of brake when motor stops	Depended	Set it when motor with brakes Default setting is "0", setting unit is 10ms.		
Pn201	Encoder cycle-divided ratio (Pulse output No. per motor cycle by encoder after cycle-divided)	Right-side	Gain Encoder	Type	Encoder Pulse No. per Motor Circle (pulses/ revolution)
				A	13bit 2048
				B	16bit 16384
C	17bit 32768				
Pn202	Electronic gear ratio (numerator)	Need Calculation	Pn202 = pulse No. of each encoder circle × 4 × mechanical deceleration ratio. Pn203 = (lead screw pitch/ pulse equivalent). Typical value: pitch 5mm, encoder 17-bit, coaxial connection between motor and screw, pulse equivalent 0.001mm, Pn202 = 16384; Pn203 = 625. Pitch 5mm, encoder 17-bit, coaxial connection between motor and screw, pulse equivalent 0.0005mm, Pn202 = 8192; Pn203 = 625.		
Pn203	Electronic gear ratio (denominator)	Need Calculation			

11.1.2. Parameter Setting of DELTA ASDA-A Servo Driver

Para. No.	Function	Format & Range	Value	Description
P0-02	Driver status display		02	Monitor if the number of sent and received pulse is correct by setting this parameter. In Weihong control system, the correct quantity of pulse sent by control card is detected by pulse inspection in order to determine whether there is electrical interference.
P1-00	External pulse input type	ZYX	002	X=2: pulse + direction; Z=0: positive logic
P1-01	Control mode setup	ZYX1X0	0000	Z=0: during control mode switching, DIO is maintaining the set value, regardless of mode switching, so Z=0. Y=0: forward rotation (CCW) (in terms of load), Y=1, the rotation direction is reversed; X1X0=00: position control mode
P1-32	Motor stop mode selection	YX	00	Y=0: when there is no servo enabled, motor dynamic brake occurs; Y=1: motor is free. X=0: motor stops instantly, X=1: motor stops with deceleration.
P1-44	Electronic Gear Ratio (Numerator) (N1)	1~32767	Need calculation	N1/M= encoder pulses× 4× pulse equivalent× mechanical deceleration ratio / pitch. Representative value: encoder pulses=2500, pitch=5mm, pulse equivalent=0.001, deceleration ratio=1, calculation as below:
P1-45	Electronic Gear Ratio (Denominator) (M)	1~32767	Need calculation	N1/M= 2500×4×0.001/5 = 2 / 1, N1=2, M=1; When the multi-electronic gear ratio is not used, P2-60~ P2-62 are not required.
P2-10	Digital Input Pin DI1	X2X1X0	101	X1X0=01: digital input (DI1=SON) corresponds to 9th pin of CN1. X2 = 1: set DI1 input as NO (normally open) a-contact point.
P2-15	Digital Input pin DI6	X2X1X0	100	Default factory setting of DI6 and DI7 are NC (normally closed) limit signal input pins; driver can't run without being connected to pin 32 and pin 31 of CN1. X2=1: set DI6 and DI7 inputs as NO (normally open) a-contact points; X1X0=00, limit signal input of the driver is not used.
P2-16	Digital Input Pin DI7	X2X1X0	100	

P2-17	Function setting for digital input pin DI8	X2X1X0	100	External EMG stop input is not used.
P2-21	Function setting for digital output pin DO4	X2X1X0	108	DO4 corresponds to pin 1 & pin 26, used as clamping-position brake signal of Z-axis; X2=1: set DO4 output as NO (normally open) a-contact point; X2=0: set DO4 output as NC (normally closed) b-contact point; X1X0=08: set pin 1 and pin 26 as BK+ and BK- respectively.
P2-22	Function setting for digital output pin DO5	X2X1X0	007	DO5 corresponds to pin 28 & pin 27, used as servo alarm signal. X2=0: set DO5 output as NC b-contact point. X1X0=07: set pin 28 and pin 27 as ALRM+ and ALRM- respectively.
2-51	Servo ON (SON) setup		0	0: Servo ON must be triggered by numerical input signal. 1: when servo is powered, if there is no alarm signal, servo will be on automatically. Set 1 when there is no SON signal line.

11.1.3. Parameter Setting of DELTA ASDA-A2 Servo Driver

Para. No.	Function	Format & Range	Value	Description
P0-02	Driver status display		02	Monitor if the number of sent and received pulse is correct by setting this parameter. In Weihong control system, the correct quantity of pulse sent by control card is detected by pulse inspection in order to determine whether there is electrical interference.
P1-00	External pulse train input type	ZYX	002	X=2: pulse + direction; Z=0: positive logic
P1-01	Set control mode	ZYX1X0	0000	Z=0: during control mode switching, DIO is maintaining the set value. Since switching control mode is not used, Z=0; Y=0: forward rotation (CCW) (from the view of load); Y=1: the rotation direction is reversed. X1X0=00: position control mode
P1-44	Electronic Gear Ratio (Numerator)(N1)	1~32767	Need calculation	N1/M= mechanical deceleration ratio × 4 × encoder pulses× pulse equivalent / pitch. Representative value: encoder pulses=2500, pitch =5mm, pulse equivalent=0.001, deceleration ratio = 1, calculation as below: N1 / M = 2500×4×0.001/5 = 2/1, N1=2, M=1; When the multi-electronic gear ratio is not used, P2-60 ~P2-62 are not required.
P1-45	Electronic Gear Ratio (Denominator)(M)	1~32767	Need calculation	
P2-10	Digital Input Pin 1 (DI1)	X2X1X0	101	X1X0=01: digital input (DI1 = SON) corresponds to 9 th pin of CN1. X2=1: set DI1 input as NO (normally open) a-contact point.
P2-15	Function setting for digital input pin DI6	X2X1X0	100	Default factory setting of DI6 and DI7 is NC (normally closed) limit signal input; driver can't run without being connected to pin 32 and pin 31 of CN1. X2=1: set DI6 and DI7 input as NO a-contact points. X1X0=00, limit input of driver is not used.

P2-16	Function setting for digital input pin DI7	X2X1X0	100	
P2-17	Function setting for digital input pin DI8	X2X1X0	100	External EMG stop input is not used.
P2-21	Function setting for digital output pin DO4	X2X1X0	108	DO4 corresponds to pin 1 & pin 26, used as clamping-position brake signal of Z-axis; X2=1: set DO4 output as NO (normally open) a-contact point; X2=0: set DO4 output as NC (normally closed) b-contact point; X1X0=08: set pin 1 and pin 26 as BK+ and BK- respectively.
P2-22	Function setting for digital output pin DO5	X2X1X0	007	DO5 corresponds to pin 28 & pin 27, used as servo alarm signal. X2=0: set DO5 output as NC b-contact point. X1X0=07: set pin 28 and pin 27 as ALRM+ and ALRM- respectively.

11.1.4. Parameter Setting of PANASONIC MINAS_A4 Servo Driver

Para. No.	Function	Value	Description
01	LED initial status	12	Monitor if the number of sent and received pulse is correct by setting this parameter. In Weihong control system, the correct quantity of pulse sent by control card is detected by pulse inspection in order to determine whether there is electrical interference.
02	Select control mode	0	0: position mode 1: velocity mode 2: torque mode
40	Select command pulse input	1	1: input through difference exclusive circuit
42	Select command pulse input mode	3	Set command pulse input mode: command pulse + command direction, negative logic
48	The 1st numerator of the command pulse frequency multiplication	Need calculation Range: 1~10000	Typical values: pitch 5 mm, encoder resolution 10000, shaft coupling direct drag, pulse equivalent 0.001 mm: Pr48=10000 Pr4B= pitch 5mm/ pulse equivalent 0.001mm=5000 So, Pr48/Pr4B=10000/5000=2/1
4B	Denominator of the command pulse frequency multiplication	Need calculation Range: 1~10000	

After the parameters are set, writing mode of EEPROM has to be selected. Please refer to the following steps:

- ① Press [MODE] button → Select [EEPROM] → Enter mode [EE_SET];
- ② Press SET button, showing [EEP —];
- ③ Keep pressing UP direction key for approx. 3 seconds, then [EEP ——] will be displayed, and then writing starts until [Start] is displayed.

If [Finish] is displayed after saving the parameters, it means successful modification. If [Reset] is shown, alteration will be validated only after restarting the driver. If [Error] occurs, the write-in is a failure, and another setting is needed.

11.1.5. Parameter Setting of MITSUBISHI MR-E Servo Driver

Para. No.	Code	Function	Value	Description
0	*STY	Select control mode and regenerative fittings	X0X0	Bit 0: set 0: select position control mode. Bit 1, select motor series: 0: HC-KFE; 1: HC-SFE; Bit 3, select regenerative apparatus, set 0: not use. Bit 4, select motor power.
3	CMX	Electronic gear numerator	Need calculation	CMX/CDV=command unit × servo motor resolution × mechanical deceleration ratio / pitch of lead screw.
4	CDV	Electronic gear denominator	Need calculation	E.G., pitch 5 mm, encoder resolution 10000, shaft coupling direct drag, pulse equivalent 0.001 mm, CMX/CDV=10000×0.001/5 = 2/1; When pulse equivalent = 0.0005mm, CMX/CDV = 1/1. Electronic gear ratio range: 1/50 ~ 500
18	*DMD	Status display selection	00XX	3: cumulative command pulses E: load inertia When the parameter is set [3], monitor if the number of sent and received pulse is correct by setting this parameter. In Weihong control system, the correct quantity of pulse sent by control card is detected by pulse inspection to determine if there is electrical interference.
21	*OP3	Function selection 3 (command pulse format selection)	0001	Set pulse command input form: pulse train+ sign, negative logic
41	*DIA	Signal input SON-ON, LSP-ON and LSN-ON automatically selection	0110	Bit 0: Servo-ON selection. [0]: servo on by external input; [1]: servo on all the time inside. Bit 1: last signal of positive rotation range (LSP): [1]: auto servo on inside, without external wiring. Bit 3: last signal of negative rotation range (LSN) : [1]: auto servo on inside and no need of external wiring.

11.1.6. Parameter Setting of FUJI FALDIC-β Servo Driver









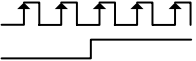
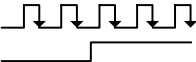

Para. No.	Name	Value	Description
01	Command pulse numerator α	Need calculation 1~32767	Command pulse numerator and denominator are also equal to those of the electronic gear ratio. $\alpha / \beta = \text{encoder resolution} \times \text{pulse equivalent} \times \text{mechanical deceleration ratio} / \text{screw pitch}$.
02	Command pulse denominator β	Need calculation 1~32767	Typical value: encoder resolution 65536, pitch 5mm, pulse equivalent 0.001, mechanical deceleration ratio 1, $\alpha / \beta = 65536 \times 0.001 / 5 = 8192 / 625$, So $\alpha = 8192$, $\beta = 625$.
03	Pulse string input form	0	Set the input mode of pulse string as: instruction + symbol, that is 'pulse + direction'.
04	Direction of rotation switch	0 or 1	Set 0: Positive direction: Forward rotation (CCW); Set 1: Positive direction: Reverse rotation (CW).
10	CONT1 signal distribution	1	CONT1 is distributed as RUN (i.e. SON); if not distributed, CONT1 will be auto ON if there is no alarming when powered.
11	CONT2 signal distribution	2	CONT2 is distributed as RST (i.e. servo alarming clearance CLR). When 12, 13, 14 are 0, that is CONT3, CONT4 and CONT5 can't be distributed as OT (over-travel) or EMG (external emergency stop).
15	OUT1 signal distribution	1	Set 1, OUT1 is distributed as a-contact point of alarming output; Set 2, OUT1 is distributed as b-contact point of alarming detection.
27	Parameter write-protection	0 or 1	Set 0, write-enable. Set 1, write-protected.
74	CONT Always ON 1	1	Its initial value is 0, and it is set "1" here to enable servo (RUN).

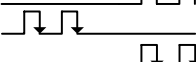
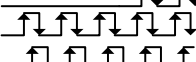
Note:

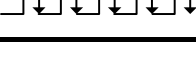
FUJI servo has no braking signal wire, so there is no need to set the parameters related to braking; you only need to provide 24V brake power to pin Br (lead wire 5 and 6) of motor with braking.

11.1.7. Parameter Setting of STONE GS Servo Driver

Para. No.	Para. Name	Value	Description																							
F0f	Electronic gear ratio numerator	2	Electronic gear ratio of position mode: $4 \times \text{pulse frequency fed back by motor encoder} = \text{command pulse frequency} \times F0f / F10$; value of $F0f / F10$ must be within 1/100~100. (calculated with pitch as 10mm)																							
F10	Electronic gear ratio denominator	1																								
F00	Control mode selection	2	<p>0: external speed running mode; make sure the value and direction of motor speed according to the external analog -10V ~ +10V signal of CN2-16, 17;</p> <p>1: internal speed running mode; make sure the value and direction of motor speed according to the setting of parameter F33, F35, F37, F39 and the port status of CN2-9, CN2-25;</p> <p>2: position pulse running mode; receive the input of external position command pulse and direction level signal;</p> <p>3: jog mode; make sure the motor speed in terms of parameter setting of F3b, and control the rotation direction by the direction keystroke ▼ and ▲;</p> <p>4: torque mode; make sure the value and direction of motor torque according to the external analog -10V ~ +10V signal of CN2-43, 1;</p> <p>5~10: mixed mode; select mode according to the port input status of CN2-24:</p> <table border="1" data-bbox="700 1319 1382 1697"> <thead> <tr> <th rowspan="2">F00 Value</th> <th colspan="2">CN2-24 Interface Status</th> </tr> <tr> <th>OFF (Mode One)</th> <th>ON (Mode Two)</th> </tr> </thead> <tbody> <tr> <td>5</td> <td>Position Pulse Mode</td> <td>External Speed Running Mode</td> </tr> <tr> <td>6</td> <td>Position Pulse Mode</td> <td>Internal Speed Running Mode</td> </tr> <tr> <td>7</td> <td>Position Pulse Mode</td> <td>Torque Mode</td> </tr> <tr> <td>8</td> <td>Internal Speed Running Mode</td> <td>External Speed Running Mode</td> </tr> <tr> <td>9</td> <td>Internal Speed Running Mode</td> <td>Torque Mode</td> </tr> <tr> <td>10</td> <td>External Speed Running Mode</td> <td>Torque Mode</td> </tr> </tbody> </table>	F00 Value	CN2-24 Interface Status		OFF (Mode One)	ON (Mode Two)	5	Position Pulse Mode	External Speed Running Mode	6	Position Pulse Mode	Internal Speed Running Mode	7	Position Pulse Mode	Torque Mode	8	Internal Speed Running Mode	External Speed Running Mode	9	Internal Speed Running Mode	Torque Mode	10	External Speed Running Mode	Torque Mode
F00 Value	CN2-24 Interface Status																									
	OFF (Mode One)	ON (Mode Two)																								
5	Position Pulse Mode	External Speed Running Mode																								
6	Position Pulse Mode	Internal Speed Running Mode																								
7	Position Pulse Mode	Torque Mode																								
8	Internal Speed Running Mode	External Speed Running Mode																								
9	Internal Speed Running Mode	Torque Mode																								
10	External Speed Running Mode	Torque Mode																								

F2e	Pulse input mode selection	2	<p>Command pulse string mode selection of position mode:</p> <p>1- single pulse string positive logic pulse <input type="checkbox"/>12 <input type="checkbox"/>27 </p> <p>direction <input type="checkbox"/>13 <input type="checkbox"/>28 </p> <p>2 - single pulse string negative logic pulse <input type="checkbox"/>12 <input type="checkbox"/>27 </p> <p>direction <input type="checkbox"/>13 <input type="checkbox"/>28 </p> <p>3 - double pulse strings positive logic CCW <input type="checkbox"/>12 <input type="checkbox"/>27 </p> <p>CW <input type="checkbox"/>13 <input type="checkbox"/>28 </p> <p>4 - double pulse strings negative logic CCW <input type="checkbox"/>12 <input type="checkbox"/>27 </p> <p>CW <input type="checkbox"/>13 <input type="checkbox"/>28 </p> <p>5 - quadrature pulse positive logic phase A <input type="checkbox"/>12 <input type="checkbox"/>27 </p> <p>phase B <input type="checkbox"/>13 <input type="checkbox"/>28 </p> <p>6 - quadrature pulse negative logic phase A <input type="checkbox"/>12 <input type="checkbox"/>27 </p> <p>phase B <input type="checkbox"/>13 <input type="checkbox"/>28 </p>
-----	----------------------------	---	---

11.2. Wiring Diagram of NK105 and Driver

11.2.1. Wiring Diagram of NK105 and Stepping Driver of Differential Input

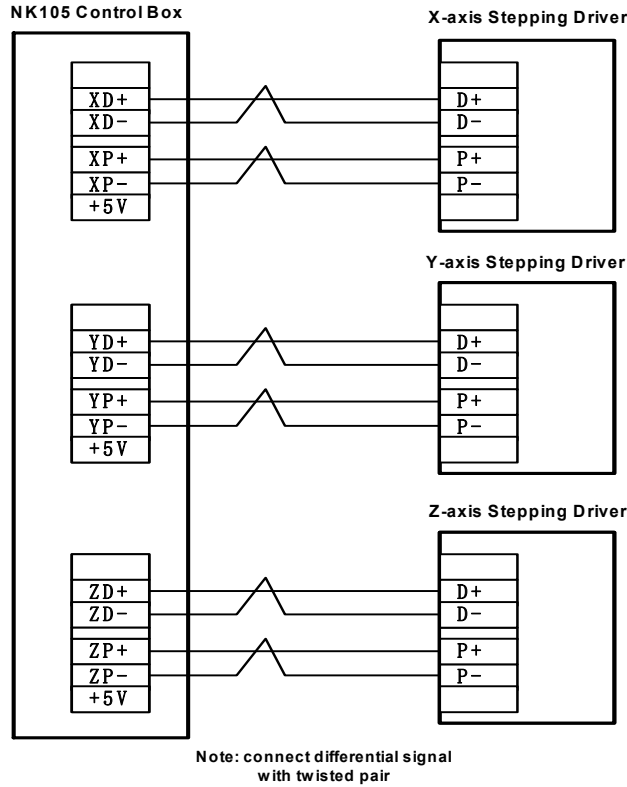

Fig. 11-1 Wiring of NK105 control box and stepping driver of differential input

11.2.2. Wiring Diagram of YASKAWA Σ -II Servo Driver

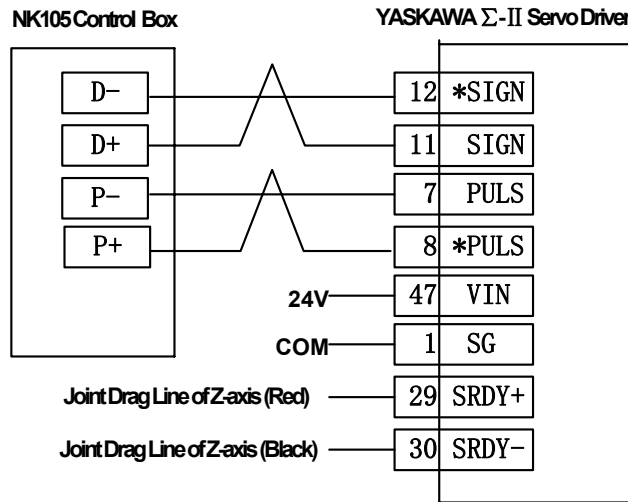

Fig. 11-2 Wiring diagram of NK105 and YASKAWA Σ -II servo driver

Note:

The wirings of X, Y and Z axes are the same, except that only Z axis has two brake drag lines which are connected with relay to control brake.

11.2.3. Wiring Diagram of DELTA ASDA_A Servo Driver

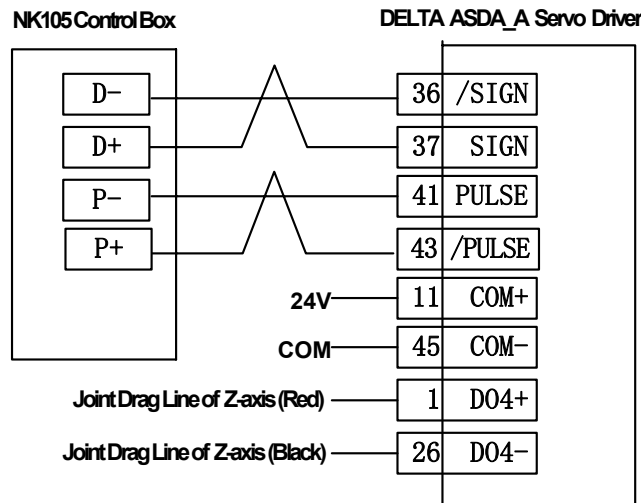

Fig. 11-3 Wiring diagram of NK105 and DELTA ASDA_A servo driver

Note:

The wirings of X, Y and Z axes are the same, except that only Z axis has two brake drag lines which are connected with relay to control brake.

11.2.4. Wiring Diagram of PANASONIC MINAS_A4 Servo Driver

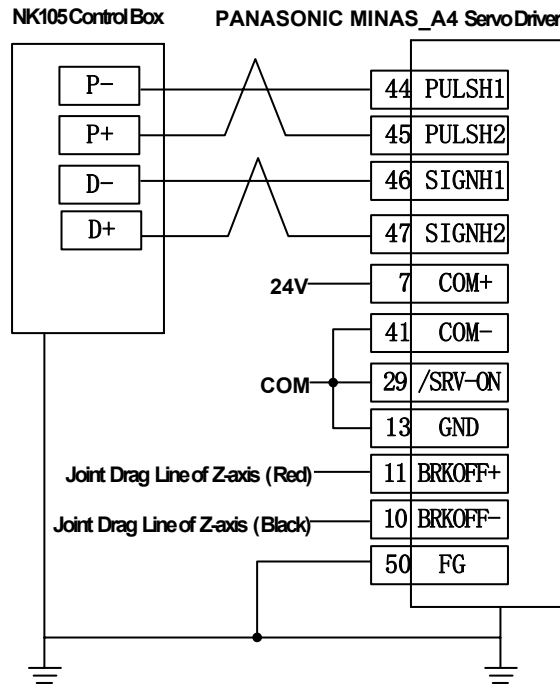

Fig. 11-4 Wiring diagram of NK105 and PANASONIC MINAS_A4 servo driver

Note:

The wirings of X, Y and Z axes are the same, except that only Z axis has two brake drag lines which are connected with relay to control brake.

11.2.5. Wiring Diagram of MITSUBISHI MR-E Servo Driver

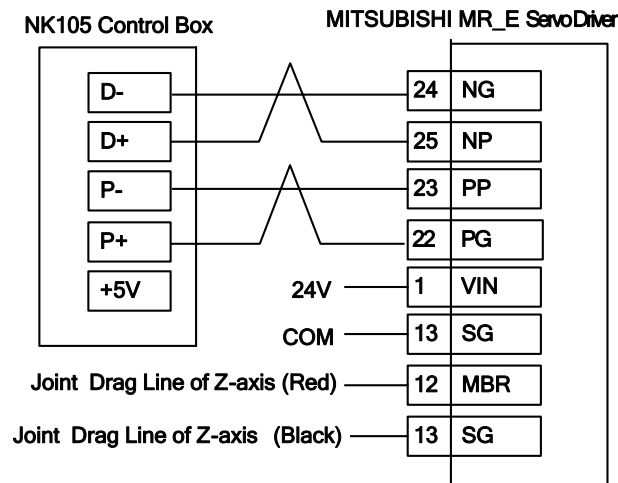

Fig. 11-5 Wiring diagram of NK105 and MITSUBISHI MR-E servo driver

Note:

The wirings of X, Y and Z axes are the same, except that only Z axis has two brake drag lines which are connected with relay to control brake.

11.2.6. Wiring Diagram of FUJI FALDIC-β Servo Driver

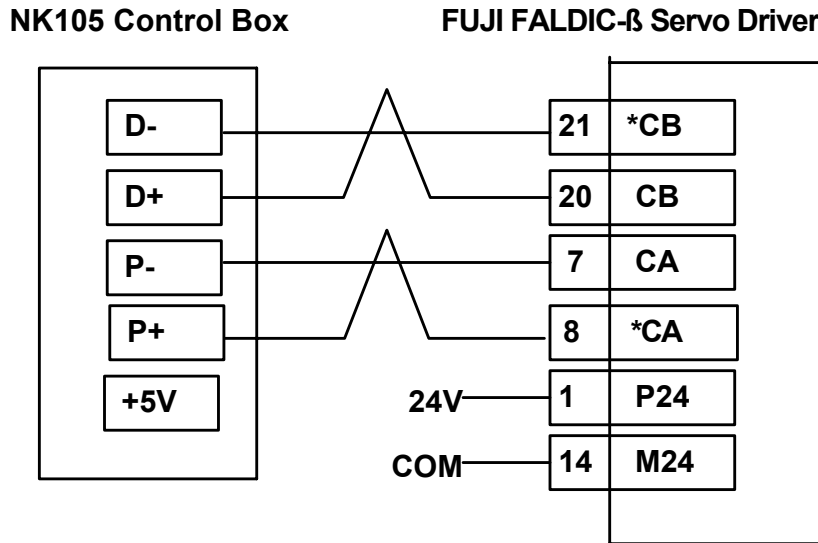

Fig. 11-6 Wiring diagram of NK105 and FUJI FALDIC-β servo driver

Note:

The wirings of X, Y and Z axes are the same, and Z-axis brake is internally controlled.

11.2.7. Wiring Diagram of STONE GS Servo Driver

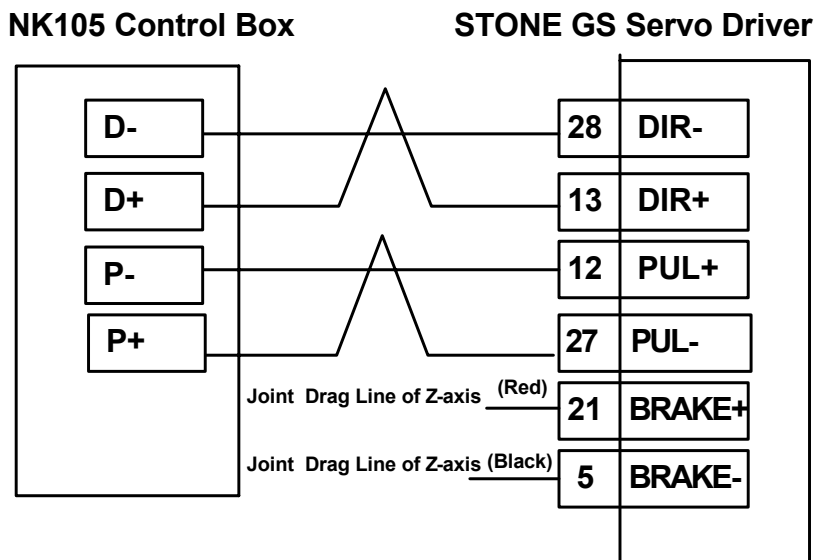

Fig. 11-7 Wiring diagram of NK105 and STONE GS servo driver

Note:

The wirings of X, Y and Z axes are the same, and Z-axis brake is internally controlled.