



FULING INVERTER

DZB100 USER MANUAL

**High-Performance/low-noise
General-Purpose AC Motor Drives**



- 220Vseries: 0.5~3.7KW
- 400Vseries: 0.5~400KW
- 660Vseries: 15~630KW
- 1140Vseries: 55~630KW

TABLE OF CONTENTS

Preface	1
Chapter 1 Introduction	2
Chapter 2 Installation and Wiring	5
Chapter 3 Digital Keypad Operation	13
Chapter 4 Start Up	19
Chapter 5 Summary of Parameter Settings	22
Chapter 6 Parameter Settings	28
Chapter 7 Troubleshooting and Fault information	62
Chapter 8 Quality Guarantee	65
Appendix A Standard Specifications	66
Appendix B Serial Communications	68
Appendix C Dimensions	75
Appendix D Accessories List	79

Preface

Thank you for choosing **DZB100** Series high-performance AC Motor Drives. **DZB100** Series are manufactured by adopting high-quality components, material and incorporating the latest microprocessor technology available.

Getting Started

This manual will be helpful in the installation, parameter setting, troubleshooting, and daily maintenance of the AC motor drives. To guarantee safe operation of the equipment, read the following safety guidelines before connecting power to the AC drives. Keep this operating manual handy and distribute to all users for reference.

WARNING

ATTENTION: Always read this manual thoroughly before using **DZB100** series AC Motor Drives.

DANGER! AC input power must be disconnected before any maintenance.

WARNING! Do not connect or disconnect wires and connectors while power is applied to the circuit.

Maintenance must be performed by qualified technicians.

WARNING! To avoid personal injury, do not remove the cover of the AC motor drive until all of the digital keypad "DISPLAY LED" lamps are off. The DC-link capacitor remains charged with a hazardous voltage even after input power is removed.

ATTENTION: Grounding the DZB100B drive is done by **connecting the Earth Ground to the drive ground terminal**.

CAUTION: There are highly sensitive components on the printed circuit boards. These components are especially sensitive to ESD (electrostatic discharge). **To avoid damage to the drive**, do not touch components or the circuit boards until static control precautions have been taken.

CAUTION: Never connect the main circuit output terminals U, V, and W directly to the AC main circuit power supply as **this will damage the drive**.

CAUTION: Do not apply the antirust to screws for fastening drives; Please clean the drives and screws with dry cloth or alcohol, not with synthetic cleaner. Fasten the screws with washers and rated torque lest the enclosure corners of drives be distorted.

This manual is for DZB100 Series AC Motor Drive.

Chapter 1 Introduction

The purpose of this chapter is to provide specific, yet simple information to **unpack, install** the AC drive. This chapter contains information on the following:

1.1 Receiving, Transportation, and Storage

1.2 Nameplate Information

1.1 Receiving, Storage and Transportation

The AC motor drive has gone through rigorous quality control tests at the factory before shipment. After receiving the AC drive, check for the following.

● **Receiving**

1. Check to make sure that the package includes an AC drive, the User Manual, dust covers and rubber bushings.
2. Inspect the unit to insure it was not damaged during shipment.
3. Make sure that the part number indicated on the nameplate corresponds with the part number of your order.

● **Storage**

The AC Drive should be kept in the shipping carton before installation. In order to retain the warranty coverage, the AC drive should be stored properly when it is not to be used for an extended period of time. Some storage suggestions are:

1. Store in a clean, dry location.
2. Store within an ambient temperature range of -20°C to $+65^{\circ}\text{C}$.
3. If possible, store in an air-conditioned environment where the relative humidity is less than 95%, non-condensing.
4. Do not store the AC drive in places where it could be exposed to corrosive gases.
5. Do not store the AC drive on a shelf or on an unstable surface.

● **Transportation**

Temperature: -25°C to $+70^{\circ}\text{C}$; R.H.: 0% to 95%;

Air Pressure: 70kPa to 106kPa.

1.2 Nameplate Information

● **Example:**

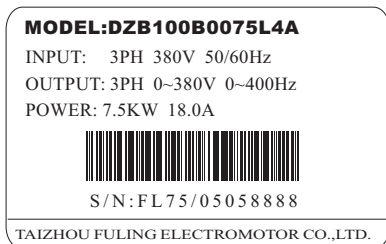

● **Description of AC Motor Drive Model:**

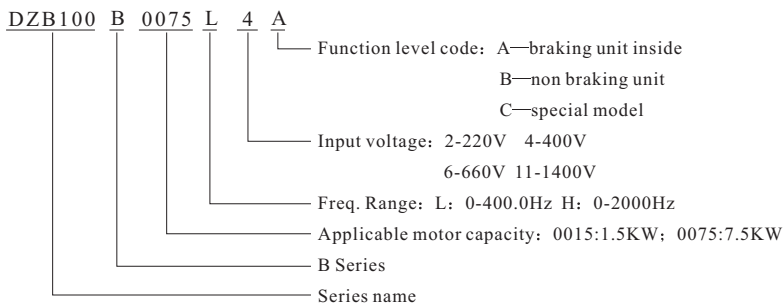

● **Description of Serial Number:**

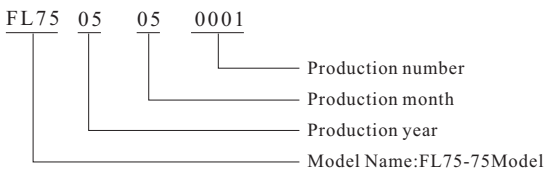

● **Description of Serial Name:**

Series Code	Explanation	Applicable Motor
B Series	High-Performance General-Purpose AC Motor Drives	0.55~400KW
P Series	Specific AC Motor Drives For Fan&Pump	7.5~400KW
S Series	Specific AC Motor Drives For Plastic Molding Machinery	7.5~280KW
H Series	Specific AC Motor Drives For High-Speed Motor	2.2~30KW (3.0~40KVA)
T Series	Specific AC Motor Drives For The Gating Of Elevator	0.55~2.2KW
L Series	Specific AC Motor Drives For Bobbin Machinery	0.55~75KW
D Series	Specific AC Motor Drives For Variable Power	15~220KVA
PP Series	Specific AC Motor Drives For Isobarically Water Supply	3.7~400KW
M Series	High-Performance Micro-Type AC Motor Drives	0.55~2.2KW

Chapter 2 Installation and Wiring

Chapter 2 provides the information needed to properly **install** and **wire** the AC drive. Make sure that the AC drive is wired according to the instructions contained in this chapter. The instructions should be read and understood before the actual installation begins.

2.1 Installation Requirements

2.2 Wiring

2.3 Basic Wiring Diagram

2.1 Installation Requirements

Install the AC drive vertically to provide proper ventilation. Adequate space is required between the drive and a wall or other equipment. The figure below shows the minimum space needed.

All enclosures must provide adequate ventilation and the internal ambient temperature must be kept at 40 °C or below.

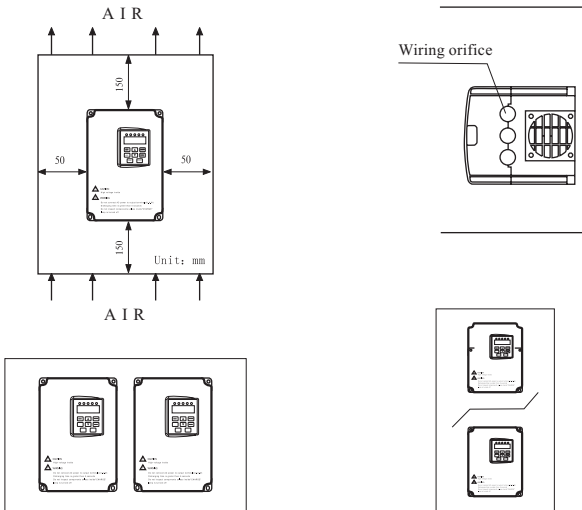

Caution: The AC drive should be installed in an environment that is:



1. protected from rain or moisture;
2. protected from direct sunlight;
3. protected from corrosive gases or liquids;
4. free from airborne dust or metallic particles;
5. free from vibration;
6. free from magnetic noise
7. temperature: -10° C to +40° C; R.H.: 0% to 90%; air pressure: 86kPa to 106 kPa

2.2 Wiring

● Main Circuit Wiring

(1) Power terminal block designations

Power input and output may be connected via a nine or ten position terminal block. The pin assignments are as follows:

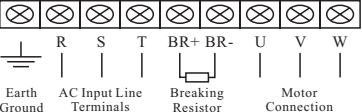
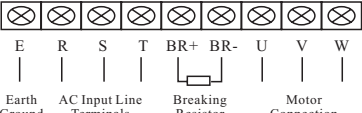
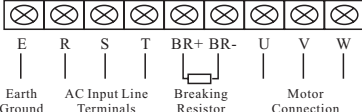
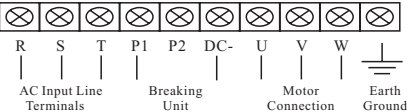
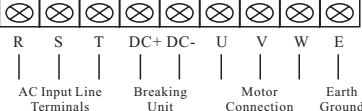
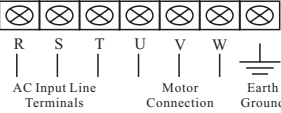
Model	Applicable motor capacity	Power terminal pin assignments
FL08	0.55~0.75KW(220V Series)	
FL22	1.5KW (220V Series)	 Earth Ground AC Input Line Terminals Motor Connection Breaking Resistor
	0.75~2.2KW(380V Series)	
FL28	0.75~1.5KW (220V Series)	 Earth Ground AC Input Line Terminals Breaking Resistor Motor Connection
	0.75~1.5KW(380V Series)	
FL37	2.2~3.7KW(220V Grade)	 Earth Ground AC Input Line Terminals Breaking Resistor Motor Connection
	2.2~5.5KW (380V Series)	
FL75	7.5~15KW(380V Series)	 Earth Ground AC Input Line Terminals Breaking Resistor Motor Connection
FL015		
FL030	18.5~30KW(380V Series)	 AC Input Line Terminals Breaking Unit Motor Connection Earth Ground
FL045	37~45KW (380V Series)	 AC Input Line Terminals Breaking Unit Motor Connection Earth Ground
FL075	55~75KW(380V Series)	
FL132	93~132KW(380V Series)	
FL160	132~160KW(380V Series)	 AC Input Line Terminals Motor Connection Earth Ground
FL220	187~280KW(380V Series)	

(2) Power block terminal designations

Terminals	Description
R, S, T(L, N)	AC input line terminals
U, V, W	Motor connection
BR+(DC+), BR-	Connection for the regenerative resistor (option)
P1(DC+), DC-	Connection for the braking unit (option)
P1, P2	Connection for the DC Link Reactor (option)
	Ground

(3) Attention:

1. The user must provide a circuit breaker or disconnect switch and fuses in accordance with all applicable electrical codes.
2. Make sure that the leads are connected correctly and the AC drive is properly grounded. (Ground leads should be at least the same size wire as the input leads R, S, and T.)
3. Use ground leads that comply with AWG standards. Make the length of these ground leads as short as possible.
4. Should several AC drive units be installed side by side, all the units should be grounded directly to the ground poles. Do not form a loop with the ground leads.

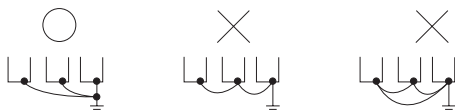

5. Make sure that the power source supplies the correct voltage and is capable of supplying the required current to the AC drive. Refer to specification for **Rated AC Input Power**. Motor Voltage should match the line voltage.
6. For single phase applications, the AC input line can be connected to any two of the three input terminals R, S, T. A single phase DZB100B drive can be powered from three phase as well as single phase.

Note: This drive is not intended for use with single-phase motors.

7. When the AC drive output terminals U, V, and W are connected to the motor terminals U, V, and W, respectively, the motor will rotate counter-clockwise (viewed from the shaft of the motor as shown below) if a forward operation command is entered (FWD lamp is ON).

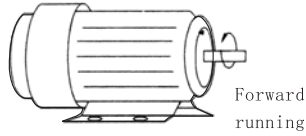

8. To reverse the direction of rotation, interchange any two connections of the three motor leads.
9. The control lines and power lines (R,S,T;U,V,W;P,N,BR+,BR-) should be separated and avoid parallel wiring lest it should generate noise and cause mis-operation.

Caution: Do not attach or remove wiring or connectors when power is applied to the AC drive.

Caution: Do not monitor the signals at any point on the circuit board while the AC drive is in operation.

Caution: Do not connect the AC input to any of the U, V, W terminals, as this will damage the AC drive.

● Control Circuit Wiring

(1) Control terminal block designations

The control leads must be routed separately from the power supply and motor leads.
They must not be fed through the same cable conduit.

Terminal Symbol

A	B	C		10V	VI	CI	FM	ACM	MO ₁	MO ₂	MCM	EV												
FWD	REV	DCM	MI ₁	MI ₂	MI ₃	RST	EF	TRG	DCM	DFM	SG+	SG-												
A	B	C	FWD	REV	DCM	MI ₁	MI ₂	MI ₃	RST	EF	TRG	DFM	DCM	MO ₁	MO ₂	MCM	10V	VI	CI	FM	ACM	EV	SG+	SG-

(2) Control terminal block descriptions

Close Contacts Terminals	Terminals Use	Function
A-B	Multi-function indication output contact	Refer to Chapter 5, F1-57
B-C	Multi-function indication output contact	
REV-DCM	Reverse / Stop	"Open"→stop,"Close" → Reverse
FWD-DCM	Forward / Stop	"Open"→stop, "Close"→ Forward
MI ₁ -DCM	Multi-function input 1	Refer to Chapter 5, F1-39, 40, 41, 42
MI ₂ -DCM	Multi-function input 2	
MI ₃ -DCM	Multi-function input 3	
MI ₄ (EF)-DCM	Multi-function input 4	
RST-DCM	Reset	"Close"→ Reset
DFM-DCM	Digital frequency meter	Digital frequency output (0, +10 V)
TRG-DCM	Counter trigger input	"Open"→"Close":(counter value)+1
MO ₁ -MCM	Multi-function PHC output 1	Refer to F1-45, 46 (open collector output)
MO ₂ -MCM	Multi-function PHC output 2	
10V-ACM	Power supply for speed setting	+10 V (20 mA max. output current)
VI-ACM	Analog voltage input	0~10 V (Max. output freq.) input
CI-ACM	Analog current input	4~20 mA (Max. output freq.) input
FM-ACM	Analog frequency/current meter	0~10 V (Max. output freq.) output
SG+-SG-	Serial communication interface	RS-485 serial port
EV-DCM	Auxiliary control power source	DC 20V ~ 24V (50mA Max.)

Note: Use twisted-shielded or twisted-pair shielded-lead wires for the control signal.

It is recommended to run signal wiring in a separate steel conduit.

The shield wire should only be connected at the drive.

● **2.3 Basic Wiring Diagram**

Users must connect wires according to the following circuit diagram shown below. Do not plug a Modem or telephone line to the RS-485 communication port, permanent damage may result. Terminals 1 & 2 are the power sources only for the optional copy keypad and should not be used while using RS-485 communication.

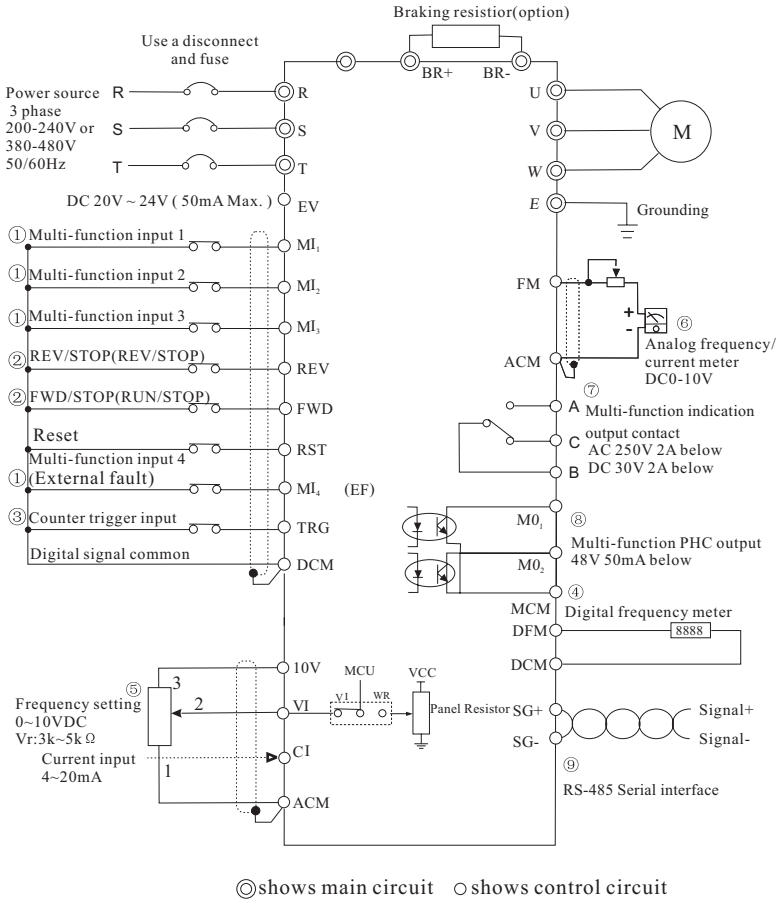

0.75KW~5.5KW

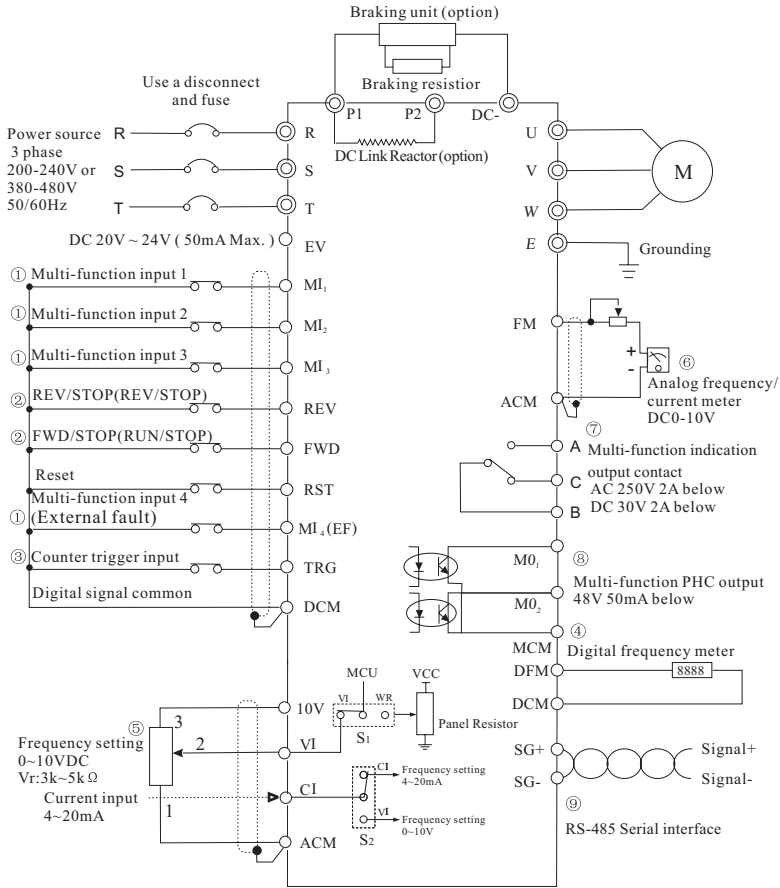

⊙ shows main circuit ○ shows control circuit

7.5KW~132KW

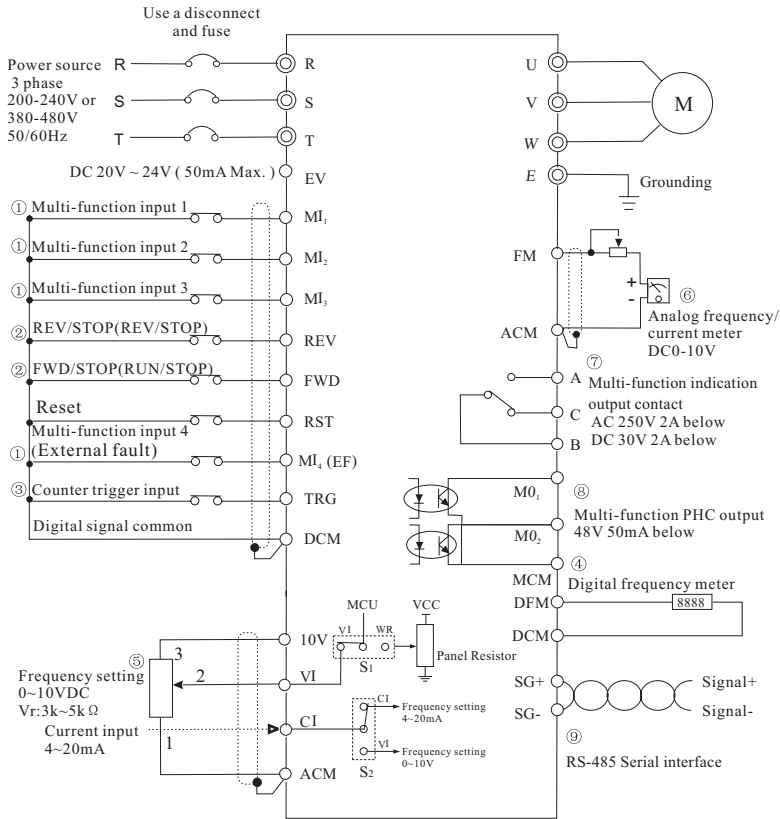

◎ shows main circuit ○ shows control circuit

Notes :

132KW~315KW

- ① Refer to F1-39, 40, 41 on page 45.
- ② Refer to F1-38 on page 44.
- ③ Refer to F1-45, 46 on page 48 and F1-63, 64, 66 on pages 55 and 56.
- ④ Refer to F1-43 on page 47.
- ⑤ Refer to F1-00 on page 28, F1-48, 49, 50 on page 49.
- ⑥ Refer to F1-42, 44 on pages 46 and 47.
- ⑦ Refer to F1-57 on page 53.
- ⑧ Refer to F1-45, 46 on page 48.
- ⑨ Refer to F1-00, 01 on page 28, F1-77, 78 on page 60 and 61.

Chapter 3 Digital Keypad Operation

Chapter 3 describes the various controls and indicators found on the digital keypad of the DZB100 AC drive. The information in this chapter should be read and understood before performing the start-up procedures described in Chapter 4.

3.1 Description of the Digital Keypad

3.2 Explanation of Screen Display





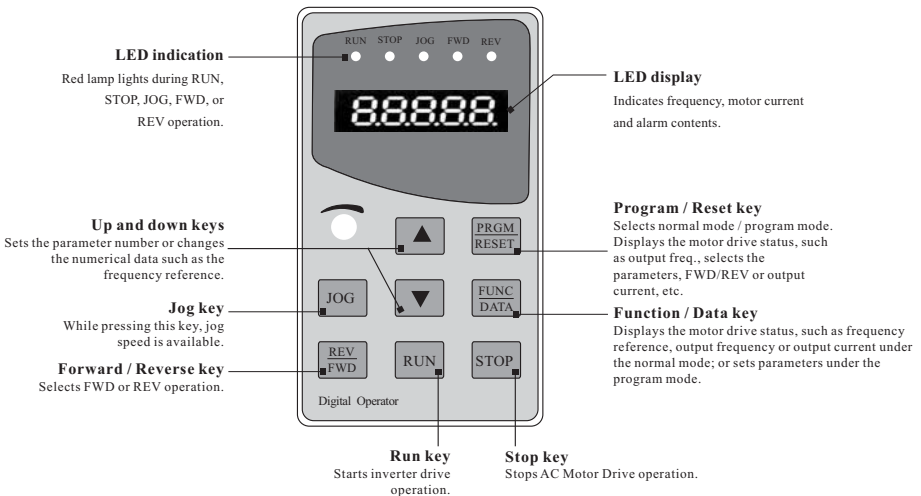

3.3 Digital Keypad Operating Modes & Programming steps

3.1 Description of the Digital Keypad

● Digital Keypad Parts and Functions

This digital keypad module includes two parts: display panel and a keypad. The display panel allows the user to program the AC drive, as well as view the different operating parameters. The keypad is the user interface to the AC motor drive. Refer to the following figure for a description of the different parts.

















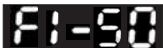

Key	Description
	<p>Program / Reset</p> <p>Used to select the Normal mode of operation or to program the AC drive when either the drive is running or has stopped. Switch to the PRGM mode to select a parameter or change the setting of a parameter. If the AC drive has stopped due to a fault, press this button to reset the drive.</p>
	<p>Function / Data</p> <p>Displays information on the AC drive status such as the reference frequency, output frequency, or output current in the normal mode. While the drive is in the Program Mode, press this key once to display the current parameters. After changing the parameters, press this key again to store the new parameters.</p>
	<p>Forward / Reverse</p> <p>Used to toggle between forward and reverse operation. Pressing this key will cause the motor to ramp down to 0 Hz and then ramp up to the preset speed in the opposite direction. By default, the digital keypad controls the AC drive forward/reverse operation. To control the forward/reverse operation via the control terminal block, change the F1-01 parameter to “0001” or “0002” .</p>
	<p>Jog</p> <p>Used to start the AC drive, then run at the jog frequency as set by the parameter specified under F1-23 [Jog Frequency].</p>
	<p>Run</p> <p>Used to start the AC drive operation. This key has no effect when the drive is set to terminal run.</p>
	<p>Stop</p> <p>Used to stop the AC drive operation.</p>
	<p>Up / Down</p> <p>Press the "Up" or "Down" button to change parameter settings. These keys may also be used to scroll through different operating values or parameters.</p>

Note: Pressing the "Up" or "Down" button momentarily changes the parameter settings in increments. Press and hold down either of these keys to rapidly run through the possible settings.

3.2 Explanation of Screen Display

● Explanation of Displayed Messages

Displayed Message	Description
	Displays the AC drive output frequency controlled by the Maximum Output Frequency (F1-03), Jog Frequency (F1-16), or by the Multi-Function Input Terminals (F1-39-41). If the frequency source originates from the Digital keypad, the user can use either the  or  key to set the frequency.
	Displays the output frequency present at terminals U, V, and W.
	Displays the input voltage.
	Displays the custom unit (n), where $n = P * F1-.65$.
	Displays the internal counter value (r). Note: Refer to Chapter 5, F1-45, 46, 63 - 66 for a detailed description of the above.
	Displays the output current present at terminals U, V, and W
	Displays the specified parameter number. The actual parameter value may be displayed by pressing the  key.
	Displays actual value stored within the specified parameter. Press the  key to store the value of the specified parameter.
	The display will read “Fd” (as shown) for approximately 1 second if the input has been accepted. After a parameter value has been set, the new value is automatically stored in memory. To modify an entry, use  or  key. Then press the  key.

● **Explanation of the LED Indicators**

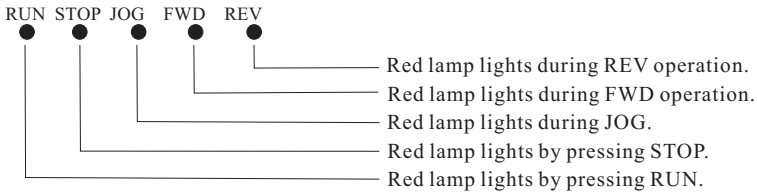

RUN or STOP lamp indication is defined by the following operation

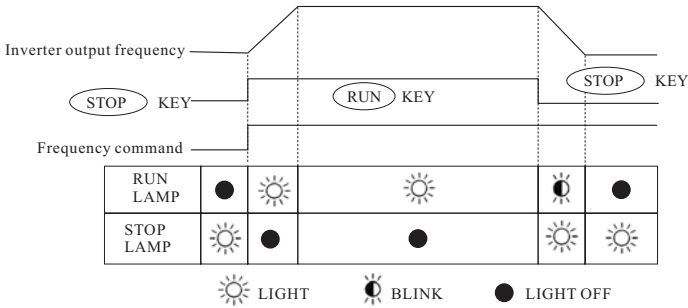

FWD or REV lamp changes indication is defined by the following operation

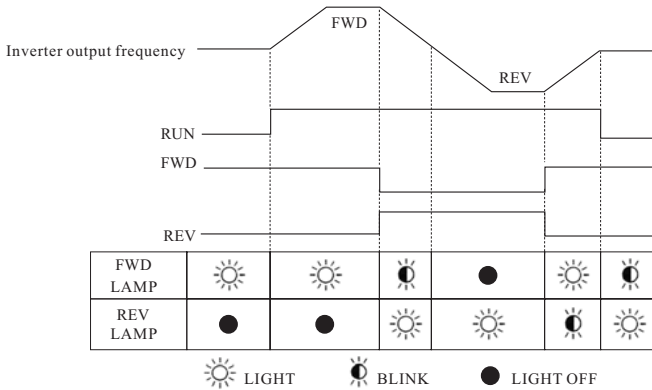

3.3 Digital Keypad Operating Modes & Programming steps

Pressing the **(RUN)** key after power on will cause the AC drive to operate at 60 Hz, which is the factory default setting. Use the **(STOP)** key to halt operation. Refer to the Basic Wiring Diagram in Chapter 2 for information on the wiring connection.

To change the operating frequency, proceed as follows:

The operating frequency may be changed in either the “STOP” or “RUN” mode.

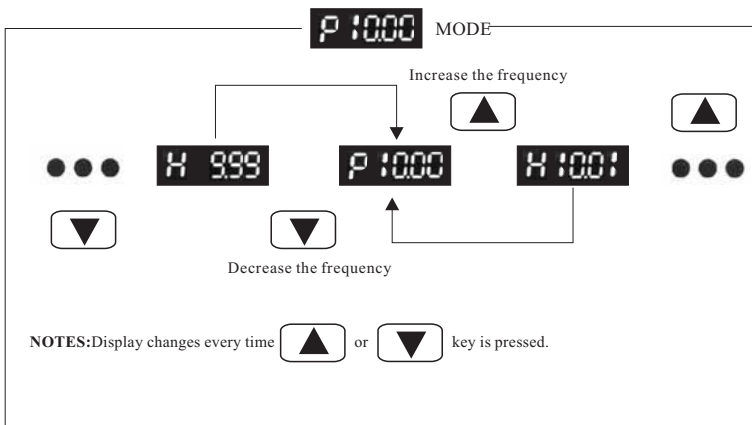
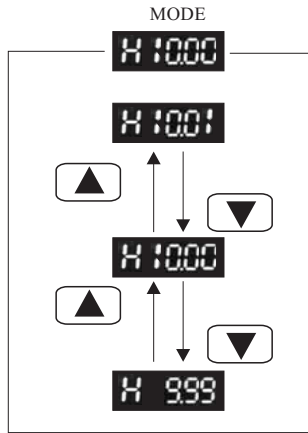

Setting parameters:

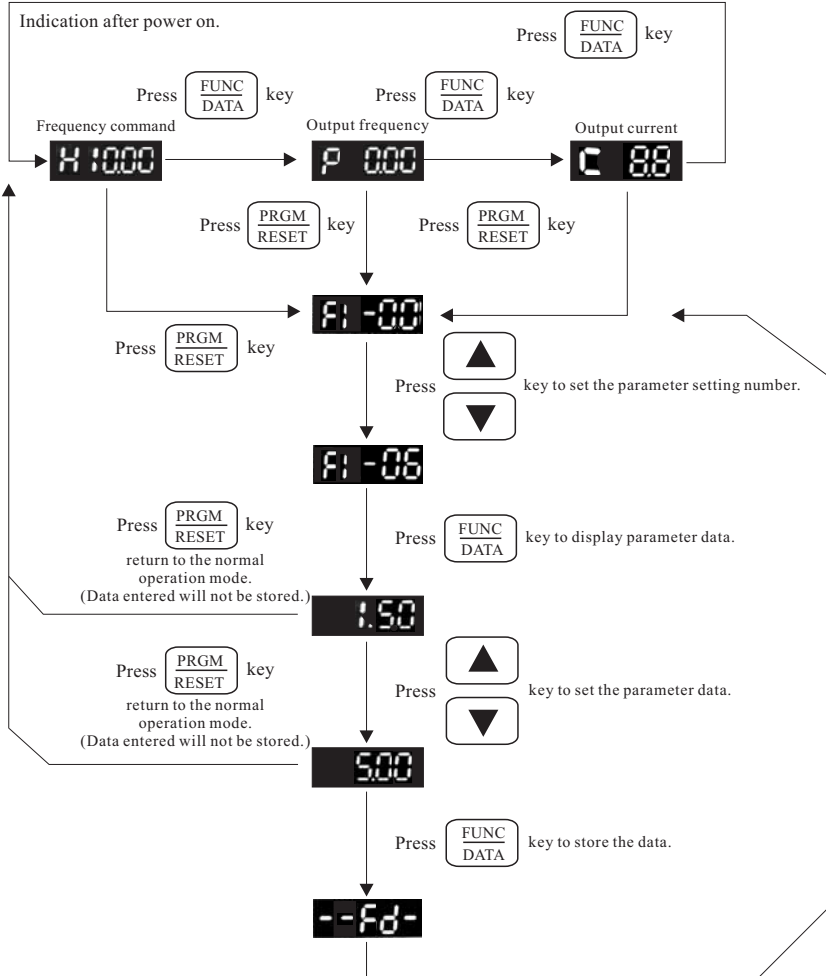

Chapter 4 Start Up

This chapter describes the steps needed to start the AC drive and typical adjustment and verification procedures to ensure a simple and efficient start-up. The following start-up procedures describe the most common parameter settings and system configurations.

4.1 Initial Operation - Motor Disconnected

- ◆ Verify that the AC power line, at the disconnect device, is within the rated power of the AC drive.
- ◆ Connect the AC drive to the power line.
- ◆ Proceed as follows to select a mode of operation.

1. Operating frequency determined by the digital keypad.

Digital keypad enabled to control AC drive operation.

(F1-00=0000, F1-01=0000) (Factory default setting)

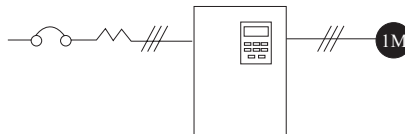

2. Operating frequency determined by the digital keypad.

Control terminals enabled to control AC drive operation; "Stop" key on digital keypad is enabled.

Two wire "REV/STOP" and "FWD/STOP" remote control enabled.

(F1-00=0000, F1-01=0001, F1-38=0000)

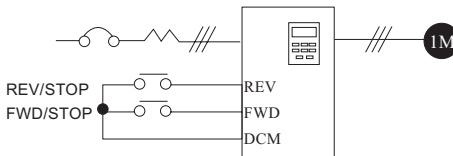

3. Operating frequency determined by the digital keypad;

Control terminals enabled to control AC Drive operation; "Stop" key on digital keypad is enabled.

Two wire "REV/FWD" and "RUN/STOP" remote control enabled.

(F1-00=0000, F1-01=0001, F1-38=0001)

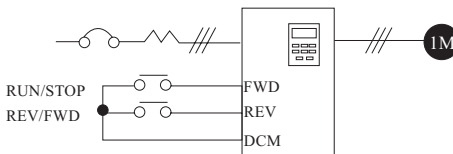

4. Operating frequency determined by the digital keypad;

Control terminals enabled to control AC Drive operation; "Stop" key on digital keypad is enabled.
Three wire sequence remote control is enabled.

(F1-00=0000, F1-01=0001, F1-38=0002)

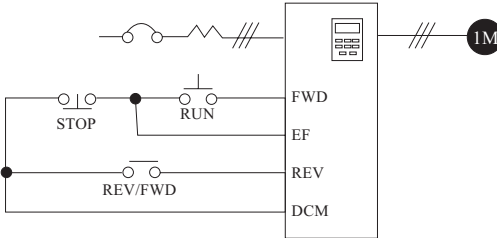

Note: Descriptions of the close / open function are as follows:

Example: ■ To select Rev and Stop operations:

Rev / Fwd Contact "close" = reverse operation

Stop Contact "open" = stop

■  Momentary input

■  Maintained input

5. Operating frequency determined by analog input; (DC 0 to +10 V) + (DC 4 to 20 mA)

Digital keypad enabled to control AC Drive operation.

(F1-00=0001, F1-01=0000)

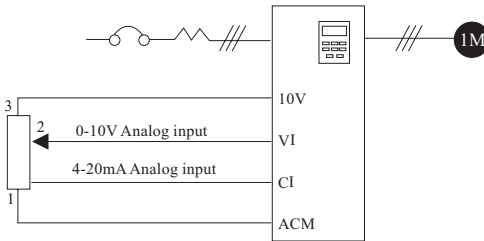

6. Operating frequency determined by remote control via the RS-485 serial interface;
 RS-485 interface enabled to control AC Drive operation.
 "Stop" key on digital keypad is enabled.(F1-00=0002, F1-01=0003)

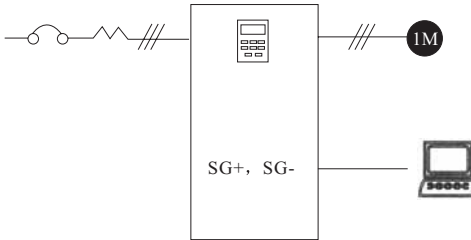

This completes the operation mode selection. Verify your operation mode works correctly, then proceed to the next section for motor connection and initial operation.

4.2 Initial Operation - Setting Parameters and connecting the Motor.

- ◆ Verify Minimum and Maximum Output Frequency Settings (F1- 08 and 03) are correct for your application.
- ◆ Verify the Motor Stop Method (F1-02) is correct for your application. If set to "Ramp to Stop", then verify the Accel/Decel Time Settings (F1-10 and 11) are correct for your application.
- ◆ Connect the motor to the terminals U, V, and W
- ◆ Check for correct motor shaft rotation (counter clockwise when viewed from the shaft).
- ◆ Verify the Stop command is functioning by pressing the Stop Key on the Digital Keypad or using your Control Terminal Stop method.

This completes the basic start-up. Depending on the application, some parameter values may need to be modified. Refer to Chapter 5 for parameter settings.

Chapter 5 Summary of Parameter Settings

This chapter summarizes all parameters.

NO.	Parameter Name	Function Explanation	Parameter Value	Factory Setting
00	Command frequency source select	Command frequency source select	0000: Command frequency input determined by the digital control panel	0000
			0001: Command frequency input determined by the analog signal (0~+10v)+(4~20mA)	
			0002: Command frequency input determined by remote control via the RS-485 serial interface	
01	Operation command source	Operation command source select	0000: Operating instructions determined by the digital control panel	0000
			0001: Operating instructions determined by the external terminal connections, keypad STOP key effective	
			0002: Operating instructions determined by the external terminal connections, keypad STOP key not effective	
			0003: Operating instructions determined by the RS-485 serial interface, keypad STOP key effective	
			0004: Operating instructions determined by the RS-485 serial interface, keypad STOP key not effective	
02	Motor stop method	Motor stop method	0000: RAMP stop	0000
			0001: Coasting to stop	
03	V / F curve setting	Max. operating	F1-04~400.00Hz	60.00
04		Max. voltage frequency	10.00~F1-03	50.00
05		Max. output voltage	50.0~250.0V/400.0V	220.0 380.0
06		Mid-point frequency	F1-08~F1-04	1.50
07		Mid-point voltage	2.0~250.0V/400.0V	20.0
08		Min. output frequency	0.01~20.00Hz	1.50
09		Min. output voltage	2.0~50.0V/100.0V	20.0
10		Accel / decel time setting	Acceleration time 1	0.1~999.9sec
11	Deceleration time 2		0.1~999.9sec	10.0
12	Acceleration time 1		0.1~999.9sec	10.0
13	Deceleration time 2		0.1~999.9sec	10.0

NO.	Parameter Name	Function Explanation	Parameter Value	Factory Setting
14	Jog accel / decel time	Jog accel / decel time select	0.1~600.0sec	10.0
15	S-curve	S-curve setting	0~7	0
16	Multi-step speed operation	Multi-step speed setting 1	0.00~400.00Hz	0.00
17		Multi-step speed setting 2	0.00~400.00Hz	0.00
18		Multi-step speed setting 3	0.00~400.00Hz	0.00
19		Multi-step speed setting 4	0.00~400.00Hz	0.00
20		Multi-step speed setting 5	0.00~400.00Hz	0.00
21		Multi-step speed setting 6	0.00~400.00Hz	0.00
22		Multi-step speed setting 7	0.00~400.00Hz	0.00
23	Jog frequency	Jog frequency select	0.01~F1-03	5.00
24	REV run setting	REV run setting	0000: REV run enable	0000
			0001: REV run disable	
25	Over-voltage stall prevention	Over-voltage stall prevention	0000: Disable over-voltage stall prevention	0001
			0001: Enable over-voltage stall prevention	
26	Over-current stall prevention	Over-current stall prevention during acceleration	50~200%	170%
27		Over-current stall prevention during operation	50~200%	170%
28	DC braking current setting	DC braking current	0~50V	0
29		DC braking time during start-up	0.0~5.0sec	0.0
30		DC braking time during stopping	0.0~25.0sec	0.0
31		DC braking start-up frequency	0.00~60.00Hz	0.00
32	Momentary power loss protection	Momentary power failure operation mode selection	0000: Operation stops after momentary power Loss.	0000
			0001: Operation continues after momentary power loss. Speed search starts with the frequency reference value.	
			0002: Operation continues after momentary power loss. Speed search starts with the minimum output frequency.	
33		Maximum allowable power loss time	0.3~5.0sec	2.0
34		Minimum base block time	0.3~5.0sec	0.5
35		Speed search current limit	30~200%	150%

NO.	Parameter Name	Function Explanation	Parameter Value	Factory Setting	
36	Reference freq. upper/lower limit setting	Reference frequency upper limit setting	0.01~400.00Hz	200.00	
37	Reference frequency lower limit setting	Reference frequency lower limit setting	0.00~400.00Hz	0.0	
38	External control terminal setting	2-wire/3-wire operation control selection	0000: FWD / STOP, REV / STOP	0000	
			0001: FWD / REV, RUN / STOP		
			0002: 3-WIRE operation control mode 1		
			0003: 3-WIRE operation control mode 2		
39	Multi-function input terminal setting	Multi-function input 1	0000: Multi-step speed command 1	0000	
40		Multi-function input 2	0001: Multi-step speed command 2	0001	
41		Multi-function input 3	0002: Multi-step speed command 3	0002	
42		Multi-function input 4	0003: Jog frequency reference select	0013	
				0004: Accel / decel speed inhibit command	
				0005: First and second accel/decel time select	
				0006: External baseblock (NO- contact input)	
				0007: External baseblock (NC- contact input)	
				0008: Up command	
				0009: Down command	
				0010: Set counter to zero	
				0011: FWD jog command	
				0012: REV jog command	
				0013: External fault(NO-contact input)	
			0014: External fault(NC-contact input)		
			0015: External baseblock,no longer startup (NO-contact input)		
			0016: External baseblock,no longer startup (NC-contact input)		
			0017: Parameter locked		
			0018: Force operating command from digital panel		
			0019: Force frequency command from digital panel		
			0020: Reserved		
			0021: Slow-paced up command		
			0022: Slow-paced down command		

NO.	Parameter Name	Function Explanation	Parameter Value	Factory Setting
43	Digital output frequency multiplier factor	Digital output frequency multiplier select	1~20	1
44	Analog output gain setting	Analog output gain select	1~200%	100%
45	Multi-function output terminal setting	Multi-function output terminal 1(MO ₁)	0000: AC drive operational	0000
46			Multi-function output terminal 2(MO ₂)	
				0002: Desired frequency attained
0003: Count down complete				
0004: Non-zero speed				
0005: Over-torque detection				
0006: Baseblock indicator				
0007: Low-voltage detect indicator				
0008: AC drive operation mode				
		0009: Fault indicator		
47	Desired frequency attained setting	Desired frequency attained	0.00~400.00Hz	0.00
48	Analog input for output frequency range	Max. output frequency voltage setting.	0.0~10.0V	10.0
49		Min. output frequency voltage setting.	0.0~10.0V	0.3
50	Analog output select	Analog output select	0000: Analog frequency meter (0 to Maximum Frequency	0000
			0001: Analog current meter (0 to 250% of the rated drive output current)	
51	Automatic voltage regulation (AVR) setting	Automatic voltage regulation (AVR) select	0000: Disable automatic voltage regulation	0001
			0001: Enable automatic voltage regulation	
52	Motor current setting	Motor rated current	30~120%	100%
53		Motor no-load current	0~99%	40%
54	Torque compensation setting	Auto torque compensation gain	0~10%	0
55	Slip compensation	Slip correction compensation	0.0~10.0	0.0
56	Reserved			
57	Multi-function indication output contact	Multi-function indication output contact (A-B) (NO) (B-C) (NC)	0000: Fault indicator	0000
			0001: AC drive operational	
			0002: Pre-set frequency attained	

NO.	Parameter Name	Function Explanation	Parameter Value	Factory Setting
			0003: Desired frequency attained	
			0004: Non-zero speed	
			0005: Over-torque detection	
			0006: Baseblock indicator	
58	User-defined frequency setting		F1-08~F1-03	10.00
59	Reserved			
60	Over-torque detection setting	Over-torque detection mode select	0000: Over-torque detection not enabled 0001: Over-torque detection during constant speed operation, operation halted after over-torque detection 0002: Over-torque detection during constant speed operation, operation continues after over-torque detection 0003: Over-torque detection during operation, operation halted after over-torque detection 0004: Over-torque detection during operation, operation continues after over-torque detection	0000
61		Over-torque detection	30~200%	150%
62		Over-torque detection time	0.1~10.0S	1.3
63	Count down value setting	Pre-set count down setting	1~9999	5
66		Count down value setting	1~9999	10
64	Function display setting	Function display setting	0000: Displays the actual operating freq.(p) 0001: Displays the user-defined setting(n) 0002: Displays the value of the internal Counter(r) 0003: Displays the output voltage(u) 0004~0012: Reserved	0000
65	Coefficient K setting for line speed		1~2000	60
67	Displays the user-defined frequency			Read only
68	Skip frequencies setting	Skip Frequency 1	0.00~400.00Hz	0.00
69		Skip Frequency 2	0.00~400.00Hz	0.00
70		Skip Frequency Band	0.01~20.00Hz	0.01
71	PWM Frequency setting	Carrier frequency select	0000: fc =1.8KHz, 0001: fc =3KHz 0002: fc =6KHz, 0003: fc =9KHz 0004: fc =9KHz, 0005: fc =15KHz	According to Standard
72	Auto reset/restart operation after fault		0~10	0

NO.	Parameter Name	Function Explanation	Parameter Value	Factory Setting
73	Fault records	Most recent fault record	0000: Fault records clear (No errors occurred)	0000
74		Second most recent fault record	0001: E009	0000
75		Third most recent fault record	0002: E00A	0000
			0003: E00E	
			0004: E008	
			0005: Manufacture used diagnostics	
			0006: E00d	
			0007: E015	
			0008: E004	
			0009: E006	
			0010: E005	
			0011: E001	
			0012: E001	
			0013: E00F	
			0014: E016	
		0015: E013		
		0016: E011		
		0017: E012		
		0018~0020: Manufacture used diagnostics		
76	Keypad Lockout/Reset	Keypad lockout/reset	0000: All parameters can always be set and read 0001: All parameters are read-only 0002~0009: Reserved 0010: Resets all parameters to the factory defaults	0000
77	Baud rate	Data rate in bps	0000: 1200 baud (Data rate bps) 0001: 2400 baud (Data rate bps) 0002: 4800 baud (Data rate bps)	0002
78	Slave address		0000~0031	0000
79	User-defined frequency setting		F1-08~F1-03	10.00
80	AC motor drive model number and software version			**##

Chapter 6 Parameter Settings

F1-00 Operating Frequency Source Select

F1- 00**Parameter Name** Master Frequency source select**Factory Setting** 0000**Settings** 0000 Master Frequency determined by the digital keypad0001 Master Frequency determined by the analog input signal
(0~+10V)+(4~20mA)

0002 Master Frequency determined by the RS-485 Interface.

-  This parameter is used to determine the AC drive command frequency source. However, the actual AC drive command frequency may also be determined by [Jog frequency], [Multi-step speed 1-7] or [Up / Down frequency], using the Multi-function inputs 1, 2, 3, and 4. Refer to F1-39, 40, 41, 42.

F1-01 Operation Command Source Select

F1- 01**Parameter Name** Operation instructions source select**Factory Setting** 0000**Settings** 0000 Operating instructions determined by the digital keypad0001 Operating instructions determined by the external terminal connections,
Keypad STOP key is enabled0002 Operating instructions determined by the external terminal connections,
Keypad STOP key is not enabled0003 Operating instructions determined by the RS-485 interface,
Keypad STOP key is enabled0004 Operating instructions determined by the RS-485 interface,
Keypad STOP key is not enabled

-  This parameter is used to determine the source of the AC Drive operating instructions.

F1-02 Motor Stop Method Select

F1-□□ 02

Parameter Name Motor stop method

Factory Setting 0000

Settings 0000 Ramp stop

0001 Coast to stop

 This parameter determines how the motor is stopped when the AC Drive receives a valid stop command.

- **Ramp** The AC drive output frequency decelerates in the time specified by F1-11 or F1-13, down to the frequency specified by (F1-08) and then the drive output turns off.
- **Coast** The AC drive is turned off immediately while the motor free runs until it comes to a complete stop.

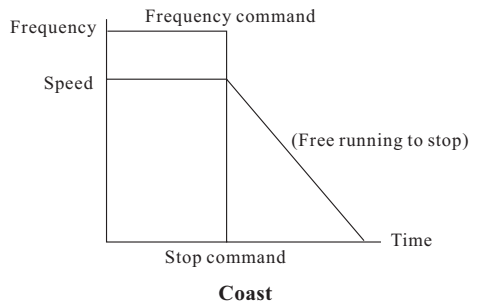
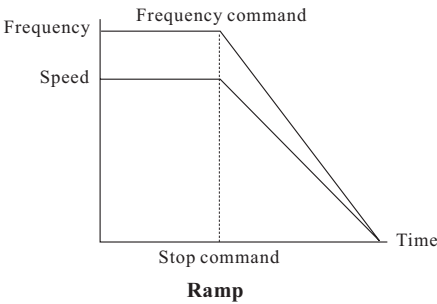

F1-03	F1-04	F1-05	F1-06	F1-07	F1-08	F1-09	V/F Curve
-------	-------	-------	-------	-------	-------	-------	-----------

F1- **□□** 03

Parameter Name Maximum output frequency

Factory Setting 60.00Hz

Unit 0.01Hz

Settings F1-04~400.00Hz

 This parameter determines the AC drive's maximum output frequency. All the AC drive analog inputs (0 - 10V, 4 - 20mA) are scaled to correspond to the output frequency range.

F1- **□□** 04

Parameter Name Maximum voltage frequency (Base frequency)

Factory Setting 50.00Hz

Unit 0.01Hz

Settings 10.00~F1-05

 This value should be set according to rated frequency of the motor as indicated on the motor nameplate.

F1- **□□** 05

Parameter Name Maximum output voltage

Factory Setting 220.0Vfor 220 V Series. 380.0Vfor 400 V Series.

Unit 0.1V

Settings 50.0~250.0Vfor 220 V Series. 50.0~400.0Vfor 400 V Series.

 This parameter determines the Maximum Output Voltage of the AC drive. The maximum output voltage setting must be smaller than or equal to the rated voltage of the motor as indicated on the motor nameplate.

F1- **□□** 06

Parameter Name Mid-point frequency

Factory Setting 1.50Hz

Unit 0.01Hz

Settings F1-08~F1-04

 This parameter sets the Mid-point frequency on the V/F curve. It may be used to determine the V/F ratio between the Minimum frequency and the Mid-point frequency.

F1- 00 07

Parameter Name Mid-point voltage

Factory Setting 20.0V

Unit 0.1V

Settings 2.0~250.0V for 220V Series. 2.0~400.0V for 400V Series.

☞ This parameter sets the Mid-point voltage on the V/F curve. It may be used to determine the V/F ratio between the Minimum frequency and the Mid-point frequency.

F1- 00 08

Parameter Name Minimum output frequency

Factory Setting 1.50Hz

Unit 0.01Hz

Settings 0.01~ 20.00Hz

☞ This parameter sets the minimum output frequency of the AC Drive.

F1- 00 09

Parameter Name Minimum output voltage

Factory Setting 20.0V

Unit 0.1V

Settings 2.0~50.0V for 220V Series. 2.0~100.0V for 400V Series.

☞ This parameter sets the minimum output voltage of the AC Drive.

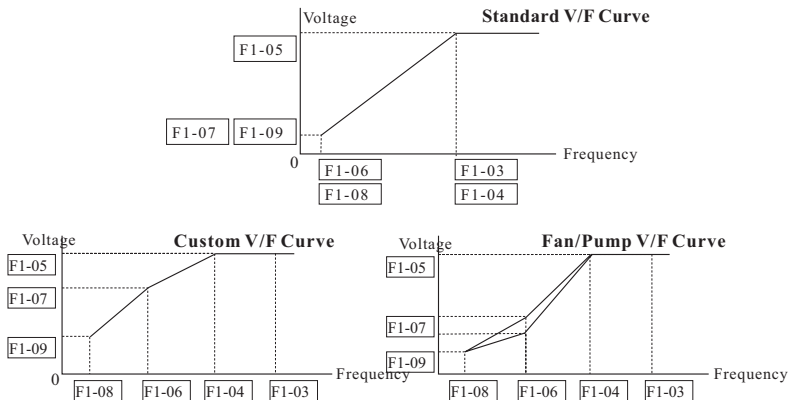

Commonly Used V / F Pattern Settings

■ General Purpose

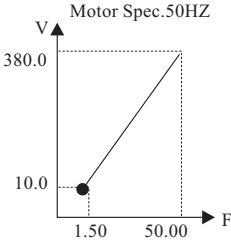

NO.	Set value
F1-03	50.00
F1-04	50.00
F1-05	380.0
F1-06	1.50
F1-07	10.0
F1-08	1.50
F1-09	10.0

■ Fans and Pumps

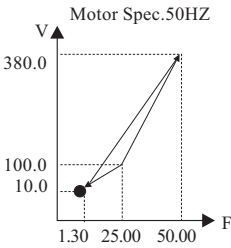

NO.	Set value
F1-03	50.00
F1-04	50.00
F1-05	380.0
F1-06	25.00
F1-07	100.0
F1-08	1.30
F1-09	10.0

■ High Starting Torque

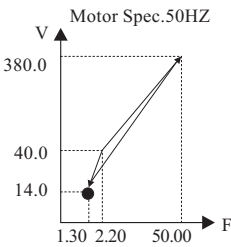

NO.	Set value
F1-03	50.00
F1-04	50.00
F1-05	380.0
F1-06	2.20
F1-07	40.0
F1-08	1.30
F1-09	14.0

F1-10 **F1-11** **F1-12** **F1-13** **Accel / Decel Time Setting**



F1- 10

Parameter Name Acceleration time 1

Factory Setting 10.0sec

Unit 0.1sec

Settings 0.1~999.9sec

-  This parameter can be programmed while the drive is running.
-  This parameter is used to determine the time required for the AC drive to ramp from 0 Hz to its Maximum operating frequency(F1-03) . The rate is linear unless S Curve is "Enabled".



F1- 11

Parameter Name Deceleration time 1

Factory Setting 10.0sec



Unit 0.1sec

Settings 0.1~999.9sec

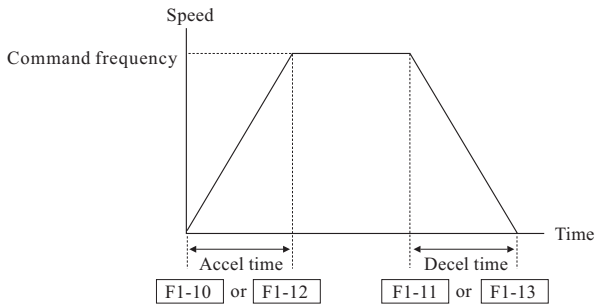

-  This parameter can be programmed while the drive is running.
-  This parameter is used to determine the time required for the AC drive to decelerate from the Maximum operating frequency (F1-03) down to 0 Hz. The rate is linear unless S Curve is "Enabled".



F1- □□ 12**Parameter Name** Acceleration time 2**Factory Setting** 10.0sec**Unit** 0.1sec**Settings** 0.1~999.9sec



-  This parameter can be programmed while the drive is running.
 -  This parameter determines the time required for the AC drive to ramp from 0 Hz to the Maximum operating frequency (F1-03). The rate is linear unless S Curve is "Enabled." Acceleration time 1 is the default. A Multi-Function Input Terminal can be programmed to select Acceleration time 1 or Acceleration time 2. See parameters F1-39, 40, 41 and 42.
-

F1- □□ 13**Parameter Name** Deceleration time 1**Factory Setting** 10.0sec**Unit** 0.1sec**Settings** 0.1~999.9sec

-  This parameter can be programmed while the drive is running.
 -  This parameter determines the time for the AC drive to decelerate from the Maximum operating frequency (F1-03) down to 0 Hz. The rate is linear unless S Curve is "Enabled." Deceleration time 1 is the default. A Multi-Function Input Terminal can be programmed to select Deceleration time 1 or Deceleration time 2. See parameters F1-39, 40, 41 and 42.
-

F1-14 Jog Accel / Decel Time

F1- □□ 14**Parameter Name** Jog Accel / Decel time select**Factory Setting** 10.0sec**Unit** 0.1sec**Settings** 0.1~600.0sec

-  This parameter can be programmed while the drive is running.
-  This parameter determines the time required for the AC Drive to ramp from 0 Hz to the Jog frequency and the time required to ramp from the Jog frequency to 0 Hz.

F1-15 S-curve

F1-□□ 15

Parameter Name S-curve setting

Factory Setting 0

Settings 0~7

☞ This parameter should be set during start-up. It is used to provide smooth acceleration and deceleration. The S-curve may be set from 1 to 7.

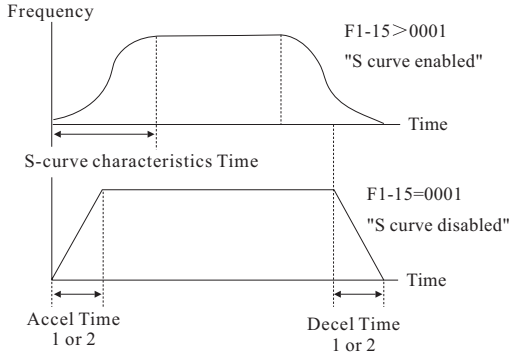

F1-16 F1-17 F1-18 F1-19 F1-20 F1-21 F1-22 Multi-speed Operation

F1-□□ 16, 17, 18, 19, 20, 21, 22

Parameter Name Multi-step speed setting 1, 2, 3, 4, 5, 6, 7

Factory Setting 0.00Hz

Unit 0.01Hz

Settings 0.00~ 400.00Hz

- ☞ These parameters can be programmed while the drive is running.
- ☞ The multi-function input terminals (refer to parameters 39, 40, 41, and 42) are used to select one of eight AC drive Multi-Speed output frequencies. The frequency is determined by F1-16 to 22.

F1-23 Jog frequency

F1-□□ 23

Parameter Name Jog frequency select

Factory Setting 5.00Hz

Unit 0.01Hz

Settings 0.01~F1-03

- ☞ This parameter can be programmed while the drive is running.
- ☞ This parameter is used to set the AC drive jog frequency. Upon receipt of a jog command the drive will ramp to the jog frequency.

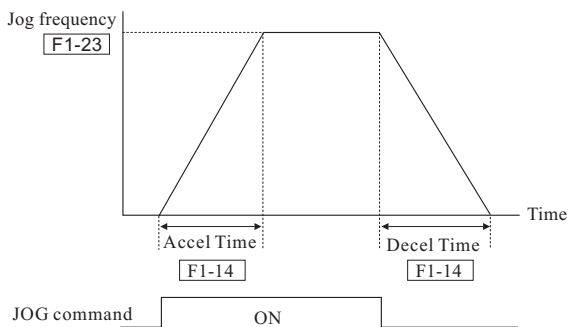

F1-24 REV Run Setting

F1- 24

Parameter Name REV Run

Factory Setting 0000

Settings 0000 REV run enabled
 0001 REV run disabled

 This parameter determines whether the AC Drive can operate in the reverse direction.

F1-25 Over-voltage Stall Prevention

F1- 25

Parameter Name Over-voltage stall prevention during deceleration

Factory Setting 0001

Settings 0000 Disable over-voltage stall prevention
 0001 Enable over-voltage stall prevention

 During deceleration, the motor DC bus voltage may exceed its maximum allowable value due to motor regeneration. When F1-25 is enabled and an over-voltage is detected, the AC drive will cease to decelerate and will then maintain a constant output frequency. The drive will only resume deceleration when the DC bus voltage drops below the preset value.

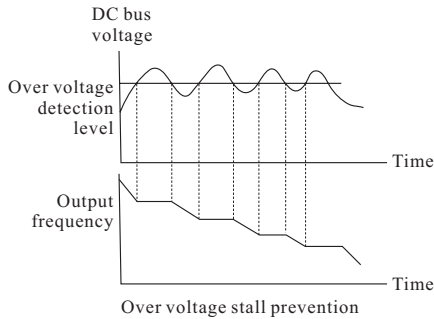

F1-26 **F1-27** **Over-current Stall Prevention**

F1- 26

Parameter Name Over-current stall prevention during acceleration

Factory Setting 170%

Unit 1%

Settings 50~200%

-  During periods of rapid acceleration or excessive load on the motor, the AC drive output current may increase abruptly and exceed the value specified by F1-26. When over-current occurs, the AC drive will cease to accelerate and will maintain a constant output frequency until the current falls below the preset value. (The drive will only resume acceleration when the current drops below the preset value.)

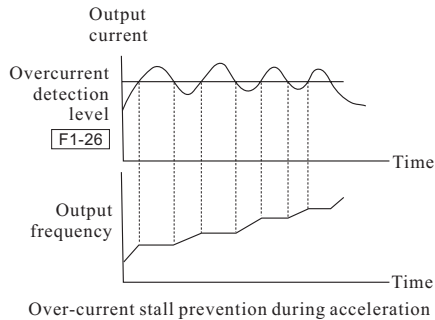

F1- **□□** 27

Parameter Name Over-current stall prevention during steady-state operation

Factory Setting 170%

Unit 1%

Settings 50~200%

- ☞ During steady-state operation with the motor load rapidly increasing, the AC drive output current may exceed the limit specified in F1-27. When this occurs, the output frequency will decrease to maintain a constant motor speed. The drive will accelerate to the steady-state operating frequency only when the output current drops below the level specified by F1-27. A setting of 100% is equal to the rated current of the drive.

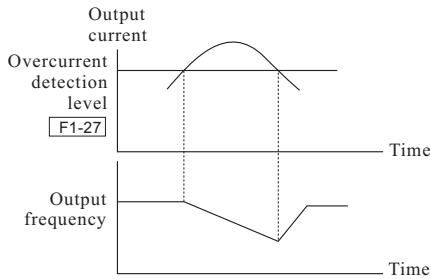

Over-current stall prevention during steady-state operation

F1-28

F1-29

F1-30

F1-31

DC Braking

F1- **□□** 28

Parameter Name DC braking voltage

Factory Setting 0

Unit 1V

Settings 0~50V

- ☞ This parameter determines the DC voltage that will be applied to the motor during braking when the Motor Stop Method is set to "RAMP stop" (refer to F1-02).

Note: When setting this parameter, begin at a lower voltage level then increase the value until sufficient holding torque is achieved. The rated motor current cannot be exceeded.

F1- 00 29

Parameter Name DC braking time during start-up

Factory Setting 0.0

Unit 0.1sec

Settings 0.0~5.0sec

☞ This parameter determines the time duration that DC braking voltage will be applied to the motor during the AC drive start-up.

F1- 00 30

Parameter Name DC braking time during stopping

Factory Setting 0.0

Unit 0.1sec

Settings 0.0~25.0sec

☞ This parameter determines the time duration that DC braking voltage will be applied to the motor when the Motor Stop Method is set to "Ramp Stop".

F1- 00 31

Parameter Name DC braking starting frequency

Factory Setting 0.00

Unit 0.01Hz

Settings 0.00~60.00Hz

☞ This parameter determines the frequency at which DC braking will start during AC drive deceleration. The frequency may be set in 0.01 Hz increments. When the preset value is less than that specified by F1-08 (Minimum output frequency), the starting frequency for DC braking will be the F1-08 frequency.

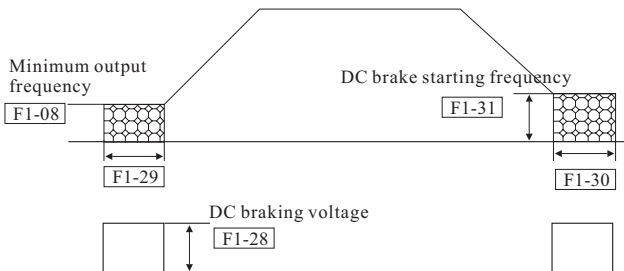

F1-32	F1-33	F1-34	F1-35	Momentary Power Loss Protection
-------	-------	-------	-------	--

F1- **□□** 32

Parameter Name Momentary power failure operation mode

Factory Setting 0000

- Settings**
- 0000 Operation stops after momentary power loss
 - 0001 Operation continues after momentary power loss.
Speed search starts with the frequency reference value
 - 0002 Operation continues after momentary power loss.
Speed search starts with the Minimum output frequency

☞ This parameter determines the AC drive mode of operation after recovery from a momentary power failure.

F1- **□□** 33

Parameter Name Maximum allowable power loss time

Factory Setting 2.0

Unit 0.1sec

Settings 0.3~5.0sec

☞ If during a power failure the power loss is less than the time defined by F1-33, then the AC drive will resume operation (set by F1-32). If the maximum allowable power loss time is exceeded, the AC drive output power will remain off and must be reset to resume operation (the fault indication will be set).

F1- **□□** 34

Parameter Name Minimum base block time

Factory Setting 0.5

Unit 0.1sec

Settings 0.3~5.0sec

☞ When a momentary power loss is detected and the power failure is less than the time set by F1-33, the AC drive output will resume operation after the specified period of time determined by F1-34. This parameter should be set to a value where the residual output voltage is nearly zero.

F1- 35

Parameter Name Speed search current limit

Factory Setting 150%

Unit 1%

Settings 30~200%

- Following a power failure, the AC drive will start its speed search operation, only if the output current is greater than the value determined by F1-35. When the output current is less than that of F1-35, the AC drive output frequency is at a "speed synchronization point". The drive will start to accelerate or decelerate back to the operating frequency at which it was running prior to the power failure.

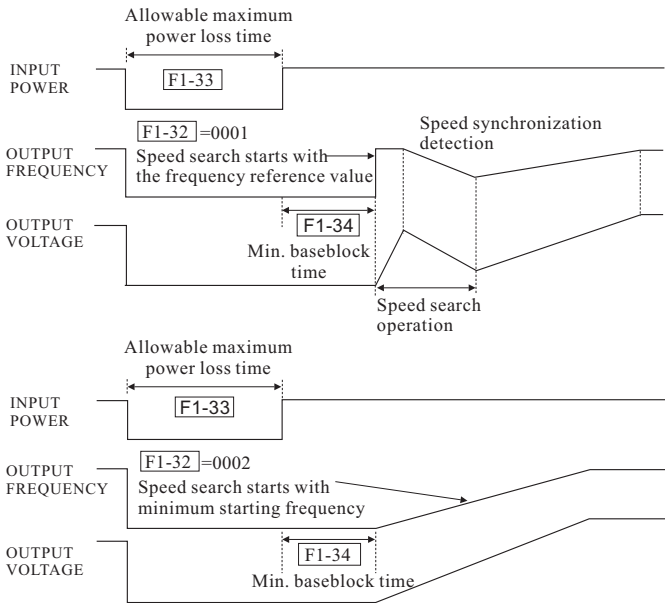

F1-36 F1-37 Reference Frequency Upper / Lower Limit

F1-□□ 36

Parameter Name Reference frequency upper limit setting

Factory Setting 200.00Hz

Unit 0.01Hz

Settings 0.01~400.00Hz

 Determines the upper limit of the reference frequency in 0.01 Hz increments.

F1-□□ 37

Parameter Name Reference frequency lower limit setting

Factory Setting 0.00Hz

Unit 0.01Hz

Settings 0.00~400.00Hz

 Determines the lower limit of the reference frequency in 0.01 Hz increments.

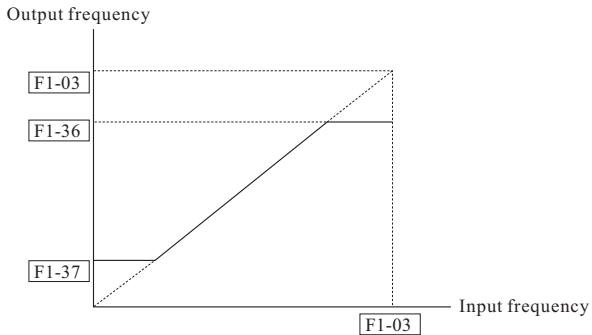

F1-38 External Control Terminal Configuration

F1- 38

Parameter Name 2-wire / 3-wire operation control selection

Factory Setting 0000

- Settings**
- 0000 FWD / STOP, REV / STOP
 - 0001 FWD / REV, RUN / STOP
 - 0002 3-WIRE operation control mode 1
 - 0003 3-WIRE operation control mode 2

 This parameter determines the control functions and operating modes available through the external control terminals.

The following configurations are available:

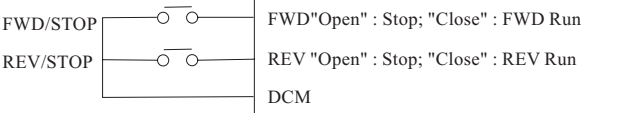
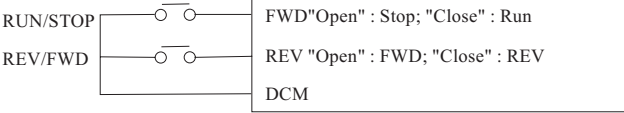
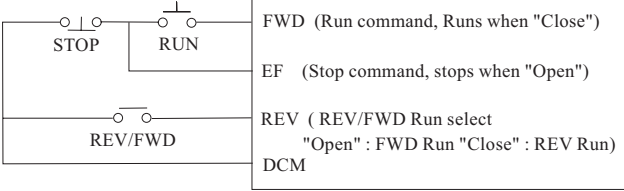
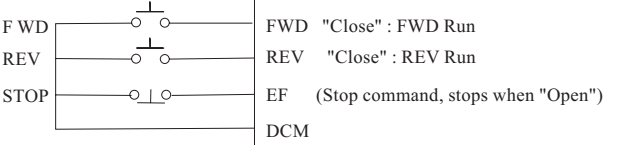
F1-38	Control terminal wiring diagram
<p>0000 Two wire FWD / STOP REV / STOP</p>	
<p>0001 Two wire REV / FWD RUN / STOP</p>	
<p>0002 Three wire operation control mode 1</p>	
<p>0003 Three wire operation control mode 2</p>	

F1-39	F1-40	F1-41	F1-42	Multi-function Input Terminals
-------	-------	-------	-------	---------------------------------------

F1- 39, 40, 41, 42

Parameter Name Multi-function input terminals 1,2,3,4

Factory Setting 0000, 0001, 0002, 0013

Settings

- 0000: Multi-step speed command 1
- 0001: Multi-step speed command 2
- 0002: Multi-step speed command 3
- 0003: Jog frequency reference select
- 0004: Accel/decel speed inhibit command
- 0005: First and second accel/decel time select
- 0006: External baseblock (NO-contact input)
- 0007: External baseblock (NC-contact input)
- 0008: Up command
- 0009: Down command
- 0010: Set counter to zero
- 0011: FWD jog command
- 0012: REV jog command
- 0013: External fault(NO-contact input)
- 0014: External fault(NC-contact input)
- 0015: External baseblock,no longer startup(NO-contact input)
- 0016: External baseblock,no longer startup(NC-contact input)
- 0017: Parameter locked
- 0018: Force operating command from digital panel
- 0019: Force frequency command from digital panel
- 0020: Reserved
- 0021: Slow-paced up command
- 0022: Slow-paced down command

 Parameter setting value limit :never same each other.

Description:

- ◆ 0000~0002: The multi-step speed commands 1 to 3 are used to determine a command frequency via the multi-step speed settings (F1-16 to F1-22).
- ◆ 0003: When "Closed", the jog reference frequency is selected.
- ◆ 0004: When "Closed", the output frequency remains constant.
- ◆ 0005: When "Open", the AC drive accelerates / decelerates according to the values set by ACCEL time 1 and DECEL time 1 (F1-10,11).
When "Closed", the AC drive accelerates / decelerates according to the values set by in ACCEL time 2 and DECEL time 2 (F1-12, 13).
- ◆ 0006: When "Closed", the AC drive output is turned off. (The reference frequency is held constant.)
- ◆ 0007: When "Open", the AC Drive output is turned off. (The reference frequency is held constant)

- ◆ 0008: When "Closed", the AC Drive output frequency is increased.
- ◆ 0009: When "Closed", the AC Drive output frequency is decreased.
- ◆ 0010: When "Closed", the internal counter is set to zero.
- ◆ 0011: When "Closed", the jog reference frequency in the forward direction is selected.
- ◆ 0012: When "Closed", the jog reference frequency in the reverse direction is selected.
- ◆ 0013: When "Closed", the AC drive external fault.
- ◆ 0014: When "Open", the AC drive external fault.
- ◆ 0015: When "Closed", the AC drive output is turned off, no longer startup.
- ◆ 0016: When "Open", the AC drive output is turned off, no longer startup.
- ◆ 0017: When "Closed", all Parameters are locked.
- ◆ 0018: When "Closed", the operating command comes from digital panel.
- ◆ 0019: When "Closed", the master frequency command comes from digital panel.
- ◆ 0020: Reserved
- ◆ 0021: When "Closed", the AC Drive output frequency is increased slow-paced.
- ◆ 0022: When "Closed", the AC Drive output frequency is decreased slow-paced.

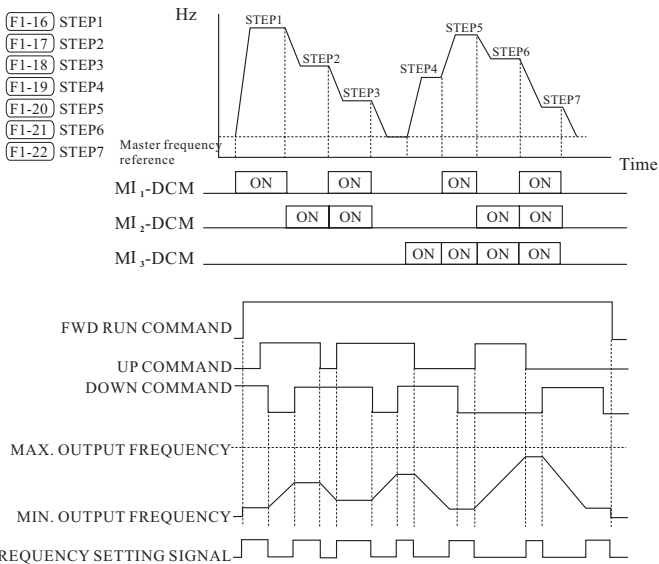

Note: When both the Up and Down command terminals are "closed", the AC drive neither accelerates or decelerates. The output frequency is also held constant.

F1-43 Digital Output Frequency Multiplier Factor

F1-□□ 43

Parameter Name Digital output frequency multiplier factor

Factory Setting 1

Unit 1

Settings 1~20

- ☞ This parameter determines the multiplying factor for the AC drive digital output frequency (+10V pulse, 50% duty cycle) at the digital output terminals (DFM, DCM).
The number of output pulses per second on DFM is equal to the AC drive output frequency multiplied by F1-43.

F1-44 Analog Output Gain Setting

F1-□□ 44

Parameter Name Analog output gain setting

Factory Setting 100%

Unit 1%

Settings 1~200%

- ☞ This parameter can be programmed while the drive is running.
- ☞ This function regulates the voltage level of the analog signal output (frequency or current) at the AFM output terminal, which is then fed to the meter.

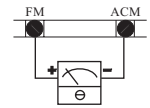
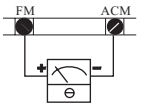
 <p>Analog frequency meter</p>	<p>The analog voltage output is proportional to the AC drive output frequency. The AC drive maximum operating frequency (F1-03) is equivalent to 10 VDC. If necessary, adjust the output level using F1-44 Analog Output Gain.</p>
 <p>Analog current meter</p>	<p>The analog voltage output is proportional to the AC drive output current. 10 VDC of analog voltage is equivalent to 2.5 times the AC drive rated output current. If necessary, adjust the output level using F1-44 Analog Output Gain.</p>

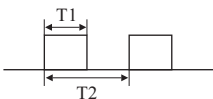
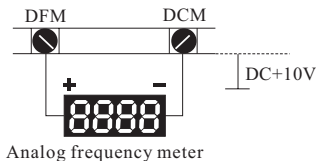

The number of output pulses per second is equal to the output frequency multiplied by [F1-43].
Note: The digital frequency output should be less than 1.2 KHz.

F1-45
F1-46
Multi-function Output Terminal Setting

 F1- 45, 46

Parameter Name Multi-function photocoupled output terminals: MO1, MO2

Factory Setting 0000, 0001

Settings	0000 AC drive operational
	0001 Pre-set frequency attained
	0002 Desired frequency attained
	0003 Count down complete
	0004 Non-zero speed
	0005 Over-torque detection
	0006 Baseblock indicator
	0007 Low-voltage detect indicator
	0008 AC drive operation mode
	0009 Fault indicator

 Control terminals MO1 and MO2 are open collector outputs. Terminal MCM is signal return.

 **Description:**
0000 AC drive operational:

This terminal will be "closed" when there is output from the AC drive or when the FWD or REV run command is input.

0001 Pre-set frequency attained:

This terminal will be "closed" once the AC drive attained the specified operating frequency.

0002 Desired frequency attained:

This terminal will be "closed" once the AC drive attained the desired operating frequency.

0003 Count down complete:

This terminal will be "closed" when the AC drive's internal counter, triggered by the external input TRG, starts countdown and reaches 0001.

Set the count down value using F1-63 and F1-66.

0004 Non-zero speed:

This terminal will be "closed" when the AC drive output frequency is greater than the minimum output frequency.

0005 Over-torque detection:

This terminal will remain "closed" as long as over-torque is detected. Set the over-torque detection level using F1-61 and the over-torque detection time using F1-62.

0006 Baseblock indicator:

This terminal will always be "closed" as long as the AC drive output is turned off.

0007 Low-voltage detect indicator:

This terminal will be "closed" when the AC drive detects a low voltage state.

0008 AC drive operation mode:

This terminal will be "closed" when the AC drive is operated by commands via the RS-485 serial interface or control terminals.

0009 Fault indicator:

This terminal will be "closed" when a major fault is detected.

F1-47 **Desired Frequency Attained Setting**

 F1- 47

Parameter Name Desired frequency attained setting

Factory Setting 0.00

Unit 0.01 Hz

Settings 0.00~400.00 Hz

 Used to select a specified frequency, set in increments of 0.01 Hz. (See F1-45, 46)

F1-48 **F1-49** **Analog Input Setting for Output Frequency Range**

 F1- 48

Parameter Name Maximum output frequency voltage setting

Factory Setting 10.0

Unit 0.1V

Settings 0.0~10.0V

 This parameter can be programmed while the drive is running.

 Sets the input signal voltage level (0 ~ 10V) that corresponds to the **maximum output frequency** (F1-03). Used in conjunction with F1-49, this parameter may be used to set the analog input for frequency command curve setting.

 F1- 49

Parameter Name Minimum output frequency voltage setting

Factory Setting 0.3

Unit 0.1V

Settings 0.0~ 10.0V

 This parameter can be programmed while the drive is running.

 Sets the input signal voltage level (0 ~ 10V) that corresponds to the **minimum output frequency** (F1-08).

Note: The absolute value of the difference between the settings of F1-48 and F1-49 should be greater than or equal to 3.

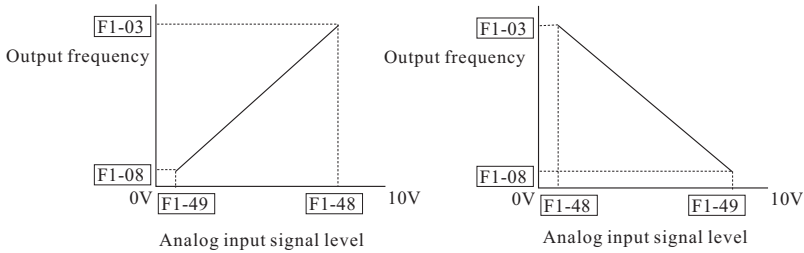

The analog input signal level is the combined input signals from the analog voltage input (VI) (0 - 10 V) and analog current input (CI) (4 - 20 mA). The voltage corresponding to the analog current input (4 - 20 mA) and analog input signal level is defined as follows:

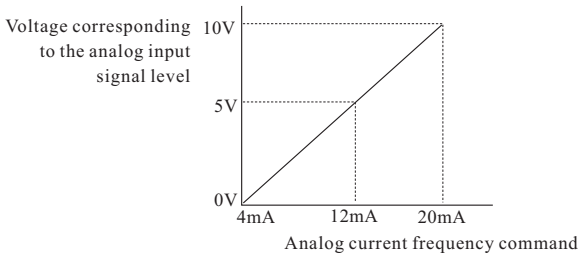

An example of such application may be illustrated as follows:

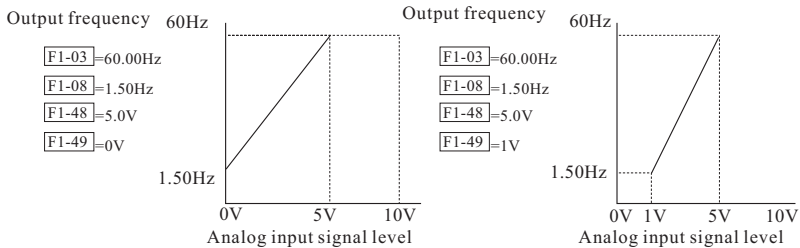

F1-50 Analog Meter Output Select

 F1- **□□** 50

Parameter Name Analog meter output select

Factory Setting 0000

Settings 0000 Analog frequency meter (0 to [Maximum Frequency])
 0001 Analog current meter (0 to 250% of the rated drive output current)

 This parameter selects the analog Meter output for either output frequency or output current (refer to Control Terminals FM, ACM).

F1-51 Automatic Voltage Regulation (AVR) Setting

 F1- **□□** 51

Parameter Name Automatic voltage regulation (AVR) select

Factory Setting 0001

Settings 0000 Disable automatic voltage regulation (AVR)
 0001 Enable automatic voltage regulation (AVR)

 This parameter determines whether the automatic voltage regulation function is enabled.
 When input voltage \geq output voltage pre-set,
 this function will ensure output voltage invariableness.
 When input voltage $<$ output voltage pre-set,
 this function will ensure Output Voltage Proportional to Input Voltage

F1-52 F1-53 Motor Current Setting



 F1- **□□** 52

Parameter Name Motor rated current

Factory Setting 100%

Unit 1%

Settings 30~ 120%

 This parameter can be programmed while the drive is running.
 This parameter must be set according to the motor specification found on its nameplate. This setting will limit the AC drive output current in order to prevent the motor from overheating. When the motor current exceeds this value, the output frequency will be reduced until the current drops below this limit.



F1- **□□** 53

Parameter Name Motor no-load current

Factory Setting 40%

Unit 1%

Settings 0~99%

-  This parameter can be programmed while the drive is running.
-  This parameter sets the motor no-load current in 1% increments.

F1-54 Torque Compensation Setting



F1- **□□** 54

Parameter Name Auto torque-compensation

Factory Setting 0

Unit 1%

Settings 0~10%

-  This parameter can be programmed while the drive is running.
-  This parameter may be set so that the AC drive will increase the voltage output during startup to obtain a higher initial starting torque. This additional torque will be present until the master operating frequency is attained.
-  **Be careful while setting the value for F1-54. If the value is too high, the motor might overheat or be damaged.**

F1-55 Slip Compensation



F1- **□□** 55

Parameter Name Slip compensation

Factory Setting 0.0

Unit 0.1

Settings 0.0~10.0

-  This parameter can be programmed while the drive is running.
-  This parameter is used to compensate for the nominal slip within a range of 0.0 -10.0. When the output current of the AC drive is greater than the motor no-load current (F1-53), the AC drive will adjust its output frequency according to F1-55.

F1-56 Reserved

F1-57 Multi-function Indication Output Contact

F1- 57

Parameter Name Multi-function indication output contact A-C(NO), B-C(NC)

Factory Setting 0000

- Settings** 0000 Fault indicator
0001 AC drive operational
0002 Pre-set frequency attained
0003 Desired frequency attained
0004 Non-zero speed
0005 Over-torque detection
0006 Baseblock indicator

 This parameter sets the multi-function programmable relay contact outputs.

F1-58 User-defined Frequency Setting

F1- 58

Parameter Name User-defined frequency setting

Factory Setting 10.00Hz

Unit 0.01Hz

Settings F1-08~F1-03

F1-59 Reserved



F1-60	F1-61	F1-62	Over-torque Detection Setting
-------	-------	-------	--------------------------------------

F1- **□□** 60

Parameter Name Over-torque detection mode select

Factory Setting 0000

- Settings**
- 0000 Over-torque detection not enabled
 - 0001 Over-torque detection during constant speed operation, operation halted after over-torque detection
 - 0002 Over-torque detection during constant speed operation, operation continues after over-torque detection
 - 0003 Over-torque detection during operation, operation halted after over-torque detection
 - 0004 Over-torque detection during operation, operation continues after over-torque detection

-  This parameter determines the AC drive operation after an over-torque is detected.
-  Over-torque detection is based on the following: When the output current exceeds the over-torque detection level (F1-61, factory preset value = 150%) and the over-torque detection time (F1-62, factory preset value = 0.1 second, †The Multi-function PHC output 1 and 2 may be set to indicate an over-torque condition. Refer to F1-45, 46. The Multi-function Indication Output (F1- 57) may also be set to indicate an over-torque condition.

F1- **□□** 61

Parameter Name Over-torque detection level

Factory Setting 150%

Unit 1%

Settings 30~200%

-  This parameter sets the over-torque detection level at 1% increments. The AC drive rated current is regarded as 100%.

F1- **□□** 62

Parameter Name Over-torque detection time

Factory Setting 1.3sec

Unit 0.1sec

Settings 0.1~10.0sec

-  This parameter sets the over-torque detection time in units of 0.1 second.

F1-64 Function Display Setting

 F1- 64

Parameter Name Displays the contents of the monitored item

Factory Setting 0000

Settings 0000 Displays the actual operating frequency(p)
 0001 Displays the user-defined setting(n)
 0002 Displays the value of the internal counter(r)
 0003 Displays the input voltage(u)
 0004~0012 Reserved

 Displays the contents of the monitored item as follows:

- ◆ p: Displays the actual operation frequency
- ◆ n: Displays the user-defined setting (where $n=p \times \text{F1-65}$)
- ◆ r: Displays the value of the internal counter. This counter is triggered by an external signal provided via the external input TRG. When the counter reaches 0000 during count down, the multi-function output terminal MO1 or MO2 will be "closed" (Refer to F1-45, 46). The counter will use the value contained in F1-66 as its starting point when another count down is to be executed.

F1-65 Coefficient K Setting

 F1- 65

Parameter Name Coefficient of line speed

Factory Setting 60

Unit 1

Settings 1~2000

 This parameter can be programmed while the drive is running.

 Coefficient K determines the multiplying factor for the user-defined setting (n). The value of the user-defined setting (n) is calculated and displayed as follows:
 Display value of n = output frequency \times K.

F1-63 **F1-66** **Count Down Value Attained Setting**

F1- 63

Parameter Name Pre-set count down value attained

Factory Setting 5

Unit 1

Settings 1~9999

 When the internal counter, triggered by the external input TRG, counts down and reaches this specified value, the specified output terminal (MO1) will be closed (assuming that F1-45 is set to 0003). The output terminal (MO1) will be opened when the internal counter reaches the value specified in F1-66. (See chart below)

F1- 66

Parameter Name Count Down Value Setting

Factory Setting 10

Unit 1

Settings 1~9999

 This parameter determines the value of the internal counter. The internal counter may be triggered by an external signal via the external input TRG terminal. Upon completion of the countdown, the specified output terminal (MO2) will be closed (assuming that F1-46 is set to 0003). (See chart below)

The timing chart is illustrated as follows:

F1-45=0003 F1-63=0005
 F1-46=0003 F1-66=0010

Application example:

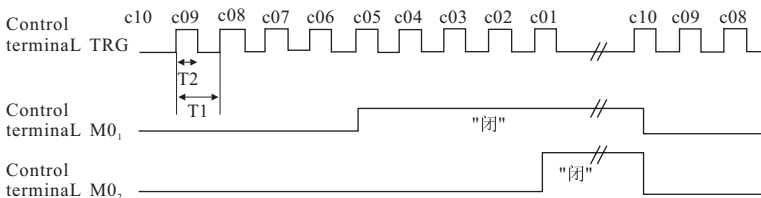

Note: The minimum On time for T2 is 2 msec or more.
 The minimum cycle time for T1 is 6 msec. or more.

F1-67 **Displays The User-difined Frequency** Read Only

F1-68 **F1-69** **F1-70** **Skip Frequencies Setting**

F1- 68, 69

Parameter Name Skip frequency 1, 2

Factory Setting 0.00

Unit 0.01 Hz

Settings 0.00~400.00Hz

 This parameter determines the two skip frequencies, which in conjunction with F1-70 [Skip Frequency Band] will cause the AC drive to skip operation at these frequency ranges. (See graph below)

F1- 70

Parameter Name Skip frequency band

Factory Setting 0.01

Unit 0.01Hz

Settings 0.01~20.00Hz

 This parameter determines the frequency band of a given [Skip frequency]. half of which is above and the other half is below the [Skip frequency] setting. Setting this parameter to 0.01 to disable all skip frequencies. (See graph below)

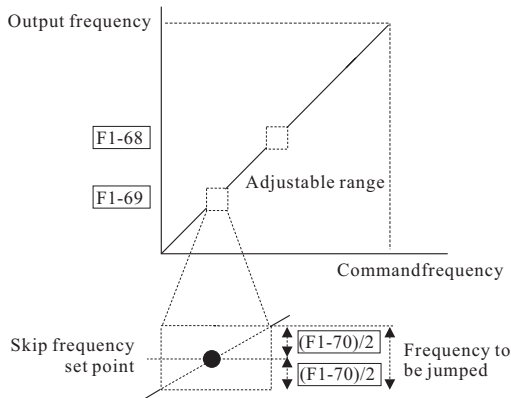

F1-71 PWM Frequency Setting

F1- 71

Parameter Name PWM frequency setting

Factory Setting According to Standard

- Settings**
- 0000: $f_c=1.8\text{KHz}$
 - 0001: $f_c=3\text{KHz}$
 - 0002: $f_c=6\text{KHz}$
 - 0003: $f_c=9\text{KHz}$
 - 0004: $f_c=12\text{KHz}$
 - 0005: $f_c=15\text{KHz}$

 This parameter determines the carrier frequency for the PWM (Pulse Width Modulation) output.

Carrier frequency	Acoustic noise	Leakage current	Heat dissipation
1.8KHz	significant ↑ ↓ minimal	minimal ↑ ↓ significant	minimal ↑ ↓ significant
3KHz			
6KHz			
9KHz			
12KHz			
15KHz			

Note: For AC drives rated below 7.5 KW (10HP), the output current derating applies above 9 KHz.
 For AC drives rated 7.5KW and above, the output current derating applies above 12KHz.
 See figure below:

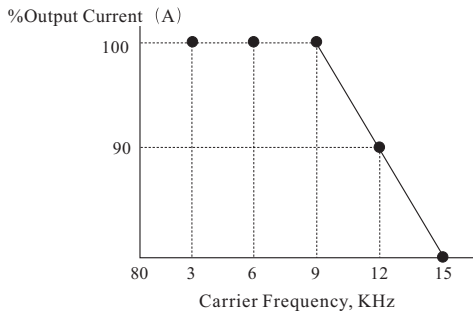

F1-72 Auto Reset / Restart Operation after Fault

F1-  72

Parameter Name Auto reset / restart operation after fault

Factory Setting 0

Settings 0~10

-  Reset / restart operation may be performed up to 10 times after a fault has occurred. Setting this parameter to 0 disables the reset / restart operation after any fault has occurred. If a protective shut-down operation (E009,E00A) occurs during operation, the auto reset / restart function can be selected. (Refer to Fault Names in Ch. 7)

F1-73 F1-74 F1-75 Fault Records

F1-  73, 74, 75

Parameter Name Three most recent fault records

Factory Setting 0000

- Settings**
- 0000 No errors occurred (Fault records clear)
 - 0001 E009 (Over-current)
 - 0002 E00A (Over-voltage)
 - 0003 E00E (Overheat)
 - 0004 E008 (Overload)
 - 0005 Manufacture used diagnostics
 - 0006 E00D (External fault)
 - 0007 E015 (CPU failure 1)
 - 0008 E004 (Over-current during acceleration)
 - 0009 E006 (Over-current during deceleration)
 - 0010 E005 (Over-current during steady state operation)
 - 0011 E001 (Low -voltage)
 - 0012 E001 (Low -voltage)
 - 0013 E00F (CPU failure 2)
 - 0014 E016 (External baseblock)
 - 0015 E013 (Over-torque)
 - 0016 E011 (Start warning)
 - 0017 E012(Shortage of input phase)
 - 0018~0020 Manufacture used diagnostics

-  These parameters store records of the three most recent faults that have occurred. If failures are got rid of ,set the parameter to 0000 to clear the fault records.

F1-76 Keypad Lockout / Reset

F1- 76

Parameter Name Keypad lockout / reset

Factory Setting 0000

Settings 0000 All parameters can always be set and read
0001 All parameters are read-only
0002~0009 Reserved
0010 Resets all parameters to the factory defaults

 This setting determines the access to the parameters and allows the user to return all parameters to the factory default settings.

F1-77 Baud Rate

F1- 77

Parameter Name Special function parameter

Factory Setting 0002

Settings 0000 1200 baud(Data rate bps)
0001 2400 baud(Data rate bps)
0002 4800 baud(Data rate bps)

 This parameter sets the communication baud rate between the personal computer and the AC drive. A personal computer may be connected to the AC drive via its RS-485 serial port. The PC may then be used to set or modify the internal parameters of the AC drive, or to control and monitor the AC drive operation. Thirty AC drives may be connected simultaneously to a personal computer.

F1-78 Slave Address

F1- 00 78

Parameter Name Slave address

Factory Setting 0

Settings 0~31

- ☞ If the AC drive is to be operated by remote control via the RS-485 serial interface, the bus address should be specified using this parameter.

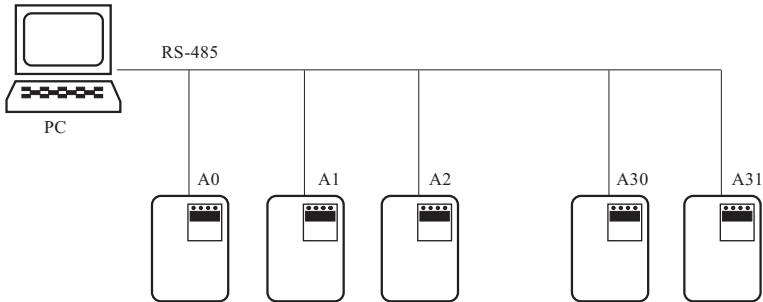

- ☞ A personal computer may be used to load, change, or monitor the parameter value through the PC's RS-485 interface, which permits communication with higher-level automation systems.

F1-79 User-defined Frequency Setting

F1- 00 79

Parameter Name User-defined frequency setting

Factory Setting 10.00Hz

Unit 0.01Hz

Settings F1-08~F1-03

F1-80 Manufacturer-used Function

- ☞ This parameter displays the firmware version number of the AC drive, which may vary according to the software version and AC drive system number.
- ☞ This parameter is read only.

Chapter 7 Troubleshooting and Fault information

The AC drive has a comprehensive fault diagnosis system. Once a fault is detected, the corresponding protective functions will be activated to turn off the AC drive output.

During any failure, the AC drive switches off and an error message will appear in the display. The three most recent faults are stored in the AC drive non-volatile memory and may be read through the digital keypad, or through the RS-485 interface on the control board.

Note: Pressing the Reset button will not restore the AC drive to its normal operating conditions unless the fault is corrected.

Fault Name	Fault Descriptions	Corrective Actions
E001	The AC drive detects that the DC bus voltage has fallen below its minimum value.	Check whether the input voltage falls within the rated AC drive's input voltage.
E004	Over-current during acceleration: 1. Short-circuit at motor output. 2. Torque boost too high. 3. Acceleration time too short. 4. AC drive output capacity too small.	Check for possible poor insulation at the output line. Decrease the torque boost setting in F1-54. Increase the acceleration time. Replace with an AC drive with higher output capacity.
E005	Over-current during steady state operation: 1. Short-circuit at motor output. 2. Sudden increase in motor loading. 3. AC drive output capacity too small.	Check for possible poor insulation at the output line. Check for possible motor stall. Replace with an AC drive with higher output capacity.
E006	Over-current during deceleration: 1. Short-circuit at motor output. 2. Deceleration time too short. 3. AC drive output capacity too small.	Check for possible poor insulation at the output line. Increase the deceleration time. Replace with an AC drive with higher output capacity.

Fault Name	Fault Descriptions	Corrective Actions
E008	<p>1.The AC drive detects excessive drive output current.</p> <p>2.The AC drive can withstand up to 150% of the rated current for a maximum of 60 seconds.</p>	<p>Check whether the motor is overloaded.</p> <p>Reduce the torque compensation setting as set in F1-54.</p> <p>Increase the AC drive's output capacity.</p>
E009	<p>The over-current hardware trip circuit detects an abnormal increase in current.</p>	<p>Check whether the motor output power corresponds to the AC drive output power.</p> <p>Check the wiring connections between the AC drive and motor for possible short circuits.</p> <p>Increase the Acceleration time 1 and 2 (F1-10,12).</p> <p>Check for possible excessive loading conditions at the motor.</p> <p>After short-circuit being removed, if there is any abnormal conditions when operating the AC Motor Drive, it should be sent back to the agency or manufacturer.</p>
E00A	<p>The AC drive detects that the DC bus voltage has exceeded its maximum allowable value.</p>	<p>Check whether the input voltage falls within the rated AC drive input voltage. Check for possible voltage transients.</p> <p>Bus over-voltage may also be caused by motor regeneration. Either increase the Decel time or add an optional braking resistor. Check whether the required braking power is within the specified limits.</p>
E00d	<p>The external terminal EF-DCM goes from ON to OFF.</p>	<p>External fault.</p>
E00E	<p>The AC drive temperature sensor detects excessive heat.</p>	<p>Ensure that the ambient temperature falls within the specified temperature range.</p> <p>Make sure that the ventilation holes are not obstructed.</p> <p>Remove any foreign objects on the heatsinks and check for possible dirty heatsink fins.</p> <p>Provide enough spacing for adequate ventilation.</p>
E00F	<p>AC drive E2PROM contains invalid data or can not be programmed.</p>	<p>Check the connections between the main control board and the power board.</p> <p>Reset drive to factory defaults.</p>

Fault Name	Fault Descriptions	Corrective Actions
E011	Realy contact don't work (Start-up warning)	Check whether the internal Realy is damaged.
E012	Shortage of input phase	Check whether the input wire breaks off. Check for possible shortage of input phase.
E013	Motor overload. Check the parameter settings F1-60, 62.)	Reduce the motor load. Adjust the over-torque detection setting to an appropriate setting.
E014	Protection circuitry of hardware detected abnormal operation.	Remove power from the AC drive and then restore power. If H.P.F. fault appears again, the AC drive should be returned for service.
E015	Drive's internal circuitry abnormal.	Switch off power supply. Check whether the input voltage falls within the rated AC drive input voltage. Switch on the AC drive.
E016 (bb)	External baseblock. AC drive output is turned off.	When the multi-function input 1 (2, 3)-DCM terminal goes from OFF to ON, the AC drive output will be turned off.
E017	<p>Ground fault or fuse failure:</p> <p>1. Ground fault : The AC drive output is abnormal. When the output terminal is grounded (short circuit current is 50% more than the AC drive rated current), the AC drive power module may be damaged. The short circuit protection is provided for the AC drive protection, not user protection.</p> <p>2. Fuse failure: The fuse failure information will be displayed by the LED located on the power board.</p>	<p>Ground fault :</p> <ol style="list-style-type: none"> 1. Check whether the IGBT power module is damaged. 2. Check for possible poor insulation at the output line. <p>Fuse failure:</p> <ol style="list-style-type: none"> 1. Replace Fuse. 2. Check whether the IGBT power module is damaged. 3. Check for possible poor insulation at the output line.

Chapter 8 Quality Guarantee

Quality guarantees of our products is transacted as the following rules and regulations:

8.1 Responsibility of manufacturer:

A: Interior

- ★ One month goods exchanging ,maintenance, and return after delivery
- ★ Three months goods exchanging ,maintenance after delivery
- ★ Twelve months goods maintenance after delivery

B:Abroad

- ★ Three months goods maintenance after delivery

8.2 Whenever and wherever use our product, users have the rights to take our service with payment.

All distributors, manufacturers and agents in the whole country can provide the service.

Our company has the right to entrust maintenance to others.

8.3 Responsibility immunity:

- ★ Abuse producing or inducing failure is out of our responsibility
- ★ The damage or referred,secondary damage caused by the fault of the equipment will not be compensated.

8.4 The equipment is guaranteed for twelve months from the date of exporting.

8.5 However the remedy of faults caused by the following reasons will be at user's cost, even though it happens during the guarantee period.

- ★ Improper operation□□unauthorized repair or modification;
- ★ Operation beyond the standard specifications;
- ★ Falling down , barbarous transport;
- ★ Device ageing and failure caused by unsuitable environment;
- ★ Damage caused by earthquake, fire, windstorm, flood, lightning ,abnormal voltage and other natural disaster, or effect hereof.

Appendix A: Standard Specifications

	Item	Description
Input	Rated Voltage	220V Class:220V±20% 50/60Hz±5Hz
	Frequency	380V Class:380V±20% 50/60Hz±5Hz
Output	Maximum Output Voltage	Proportional to Input Voltage
	Output Frequency	0.01Hz~400.00Hz (The frequency can be reached to 1500Hz by 100HSeries AC Motor Drives.)
	Overload Endurance	150% of rated current for 1 minute
Control Characteristics	Control system	SPWM (Sinusoidal Pulse Width Modulation, carrier frequency 1-15kHz)
	V / F pattern	V/F pattern,Adjustable V/F pattern
	Frequency setting precision	0.01Hz
	Frequency resolving capability	Digital setting:0.01Hz Analog setting:Maximum frequency×0.1%
	Slip compensation	Aoto slip compensation,range:0.00-10.00
	Torque compensation	Manual/aoto torque compensation,range:0%-10%
	Accel/decel time	Two curve:linear and s-curve; Two accel/decel curve,range:1.0-999.9
	Multi-step operation	Internal PLC operation;Multi-function terminal input
	Internal Counter	Realize product-line automatic count control
Operating Characteristics	Operation Setting Signal	Digital operation(Setting by RUN, STOP, FWD / REV); External signa(FWD, REV, EF can be combined for 2 or 3-wire operation, RS-485 serial interface.)
	Frequency setting	Digital operation(Setting by up/down or JOG key); External signal(Multi-function 1~4,JOG, Multi-step speed, Up / Down, 0 to 10 VDC, 4~20mA,RS-485 serial port)
	Input signal	Multi-step selection 1 ~7, Jogging, Accel. / Decel. Prohibit, First / Second Accel. / Decel. Switching command, External BB (NC, NO selection), etc.
	Output signal	During running, Up to frequency setting, Up to desired frequency setting Count out detection, Non zero-speed, Over-torque detection, etc.
	Analog / Digital Output	Analog frequency / current signal output, digital frequency signal output
	Other function	Automatic Voltage Regulation (AVR), S-Curve, over voltage, over-current stall prevention,abnormal records checking,Frequency limit, Carrier-frequency adjustable, DC braking, DB starting frequency setting, Momentary power failure restart, over-voltage stall prevention, etc.
	Display	Displays:pre-set frequency;operate frequency;output current;moto speed; internal count value;fault information,etc
	Protective function	Over-current, over voltage, under voltage, overheat ground fault,overload limit, over voltage supply, short-circuit protection of output terminals,etc.
Environments	Installation site	Indoor(no straight sunshine,keep from corrosive gasses, liquid and dust
	Altitude	1,000m or lower
	Ambient temperature	-10℃~+40℃
	Ambient Humidity	Below 90% RH (non-condensing)
	Vibration	1.0G less than 20Hz, 0.6G at 20~50Hz
	Storage temperature	-20℃-60℃
Frame	Defend grade	IP20
	Cooling Method	Forced air-cooling

◆ AC220V Series Rating:

Voltage classification(220V)		0005	0007	0015	0022	0037							
Output Rating	3 Phase motor rating(KW)	0.5	0.75	1.5	2.2	3.7							
	Inverter output(KVA)	0.7	1.0	2.0	3.0	5.0							
	Output current(A)	2.5	4.0	7.0	10	17							
	Output voltage(V)	Adjustable from 0 to input voltage											
Input Rating	Input current(A)	4.0	5.2	10	15	25							
	Operational range (V)	Single/3 phase 220V±20%, 47~63Hz											

◆ AC380V Series Rating:

Voltage classification(380V)		0007	0015	0022	0037	0055	0075	0110	0150	0185	0220	0300	0370	
Input Rating	3 Phase motor rating(KW)	0.75	1.5	2.2	3.7	5.5	7.5	11	15	18.5	22	30	37	
	Inverter output(KVA)	1.0	2.0	3.0	5.0	7.5	10	15	20	25	30	40	50	
	Output current(A)	2.5	3.7	5.0	8.5	13	18	24	30	39	46	58	75	
	Output voltage(V)	Adjustable from 0 to input voltage												
Output Rating	Input Current(A)	3.2	4.2	4.8	6.5	11	16	23	31	39	50	75	97	
	Operational range (V)	3 phase 380V±20%, 47~63Hz												
Voltage classification(380V)		0450	0550	0750	0930	1100	1320	1600	1870	2000	2200	2500	2800	3150
Input Rating	3 Phase motor rating(KW)	45	55	75	93	110	132	160	187	200	220	250	280	315
	Inverter output(KVA)	60	75	100	125	150	175	220	250	270	300	330	370	420
	Output current(A)	90	110	150	170	210	250	300	340	380	430	470	520	620
	Output voltage(V)	Adjustable from 0 to input voltage												
Output Rating	Input Current(A)	110	140	190	220	260	320	350	390	450	480	520	590	700
	Operational range (V)	3 phase 380V±20%, 47~63Hz												

Appendix B: Serial Communications

The different AC motor drive parameters can be programmed and displayed by remote control via the RS-485 serial interface. A personal computer may be used to load, change, or monitor the parameter value through the PC's RS-485 interface, which permits communication with higher-level automation systems.

This appendix describes the following:

- **Computer Control**
- **Data Format and Protocol**
- **Character Delay Time and Response Delay Time**

■ **Computer Control:**

The DZB100 series AC motor drive has a built in RS-485 serial communication port on its control terminal block marked SG+, SG-. The two connector pins are defined as follows:

SG +: Signal +

SG -: Signal -

Each DZB100 AC motor drive has a pre-assigned slave address specified by F1-78.

The computer may select any AC drive according to this slave address.

The computer may also control all of the AC drives connected to it when the "A" code in command string is 02H.

■ **Data Format and Protocol:**

● **Data Format**

- ★ Baud Rate (Transmission speed in bits per second)
- ★ Range of values: 1200, 2400, 4800 Baud (See F1-77)
- ★ Eleven (11) bits are required to represent each character, as shown in the following example:

Number of bits	1	8	1	1
Function	start bit	data bits	odd parity bit	stop bit

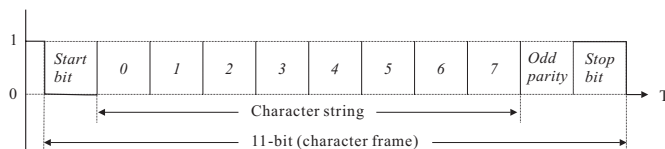

● **Protocol**

★ **Control Command**

COMMAND STRUCTURE

"C,S,A,UU,MM,FFFF"

Word length = 11 characters

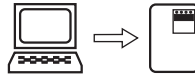

Computer to AC Motor Drive

C: Header of control string

S: Check sum (03H)

A: Command acknowledge

01H: Command acknowledged by a single AC drive

02H: Command acknowledged by all AC drives

UU: Slave address ("00" - "31")

MM: Operation command (X = don't care)

X0 Stop

X1 Forward running

X2 Stop

X3 Reverse running

X4, X5 Jog (FWD)

X6, X7 Jog (REV)

X8 Reset after AC drive error

FFFF: Frequency command, Setting range: from 0000 (0.00Hz) to 4000 (400.00Hz)

Example: A setting of "5000" = 50.00Hz

The AC drive will return a character string, the format of which will be as follows:

COMMAND STRUCTURE

"C,S,B,UU,MM,FFFF"

Word length = 11 characters

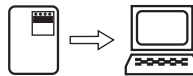

AC Motor Drive to Computer

C: Header of control string

S: Check sum (03H)

B: Acknowledge back

Correct: 06H Error: 07H

UU: Slave address ("00" - "31")

MM: Operation command (X = don't care)

X0 Stop

X1 Forward running

X2 Stop

X3 Reverse running

X4, X5 Jog (FWD)

X6, X7 Jog (REV)

X8 Reset after AC drive error

FFFF: Frequency command, Setting range: from 0000 (0.00Hz) to 4000 (400.00Hz)

Example: A setting of "5000" = 50.00 Hz

★ **Parameter Setting Command**

COMMAND STRUCTURE

"P,S,A,UU,NN,DDDD"

Word length = 11 characters

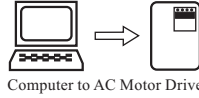

P: Header of parameter string

S: Check sum (03H)

A: Command acknowledge

 01H: Command acknowledged by a single AC drive

 02H: Command acknowledged by all AC drives

UU: Slave address ("00" - "31")

NN: Parameter number ("00" - "80")

DDDD: Data of parameter

The AC drive will return a character string, the format of which will be as follows:

COMMAND STRUCTURE

"P,S,B,UU,NN,DDDD"

Word length = 11 characters

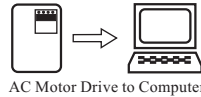

P: Header of parameter string

S: Check sum (03H)

B: Acknowledge back

 Correct: 06H Error: 07H

UU: Slave address ("00" - "31")

NN: Parameter number ("00" - "80")

DDDD: Data of parameter

★ **Parameter Read Command**

COMMAND STRUCTURE

"R,S,A,UU,NN"

Word length = 7 characters

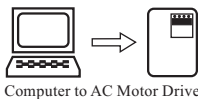

R: Header of read string

S: Check sum (03H)

A: Command acknowledge

01H: Command acknowledged by a single AC drive

02H: Command acknowledged by all AC drives

UU: Slave address ("00" - "31")

NN: Parameter number ("00" - "80")

The AC drive will return a character string, the format of which will be as follows:

COMMAND STRUCTURE

"R,S,B,UU,NN,DDDD"

Word length = 11 characters

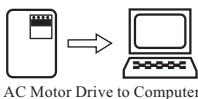

R: Header of read string

S: Check sum (03H)

B: Acknowledge back

Correct: 06H Error: 07H

UU: Slave address ("00" - "31")

NN: Parameter number ("00" - "80")

DDDD: Data of parameter

★ **AC drive Status Read Command**

COMMAND STRUCTURE

"Q,S,A,UU,NN"

Word length = 7 characters

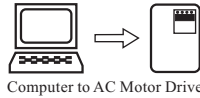

Q: Header of question string

S: Check sum (03H)

A: Command acknowledge

01H: Command acknowledged by a single AC drive

02H: Command acknowledged by all AC drives

UU: Slave address ("00" - "31")

NN: Retrieve contents of drive status. (x = don't care)

X0: Frequency command

X1: Output frequency

X2: Output current

X3: Operation command Drive status and Error code

The AC drive will return a character string, the format of which will be as follows:

COMMAND STRUCTURE

"Q,S,B,UU,NN,ABCD"

Word length = 11 characters



Q: Header of question string

S: Check sum (03H)

B: Acknowledge back

Correct: 06H Error: 07H

UU: Slave address ("00" - "31")

NN: 00 → Frequency command = ABC.D (Hz)

01 → Output frequency = ABC.D (Hz)

02 → Output current = ABC.D (Amp)

03 → Operation command, Drive status & Error code

ABCD: When NN = 00, ABC.D (Hz)
 When NN = 01, ABC.D (Hz)
 When NN = 02, ABC.D (Amp)
 When NN = 03,

A: Operation command

- 0: Stop
- 1: Forward operation
- 2: Stop
- 3: Reverse operation
- 4: Forward jog
- 5: Forward jog
- 6: Reverse jog
- 7: Reverse jog
- 8: Reset after AC drive error

B: AC drive status

"□" = Binary code bit map

bit 0: 0 = Stop 1 = Run

bit 1: 0 = Forward 1 = Reverse

bit 2: 0 = Non-DC braking start
 1 = DC braking start

bit 3: 0 = Non-DC braking stop
 1 = DC braking stop

bit no.

7 6 5 4	Frequency reference source
0 0 0 0	Keypad control
0 0 0 1	Multi-step speed command 1
0 0 1 0	Multi-step speed command 2
0 0 1 1	Multi-step speed command 3
0 1 0 0	Multi-step speed command 4
0 1 0 1	Multi-step speed command 5
0 1 1 0	Multi-step speed command 6
0 1 1 1	Multi-step speed command 7
1 0 0 0	Jog speed command
1 0 0 1	Analog input freq. command
1 0 1 0	RS-485 serial interface
1 0 1 1	Up/Down control

CD: Error code

Code	Fault Name
00	No error
01	Over-current (E009)
02	Over voltage (E00A)
03	Overheat (E00E)
04	Overload (E008)
05	Manufacture used diagnostics
06	External fault (E00d)
07	CPU fault 1 (E015)
08	Over-current acceleration (E004)
09	Over-current deceleration(E006)
10	Over-current during steady state operation (E005)
11	Low voltage (E001)
12	Low voltage (E001)
13	CPU fault 2 (E00F)
14	External Baseblock (E016)
15	Over-torque (E013)
16	Start waring (E011)
17	Shortage of input phase (E012)
18-20	Manufacture used diagnostics

■ **Character Delay Time and Response Delay Time**

● **Character Delay Time**

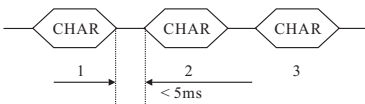

● **Response Delay Time**

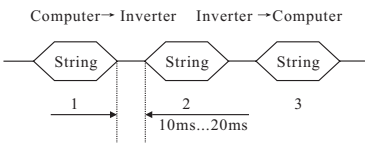

Appendix C: Dimensions

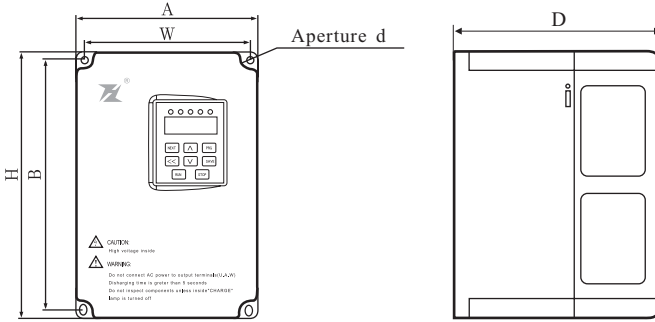

Type 1: Plastic Frame

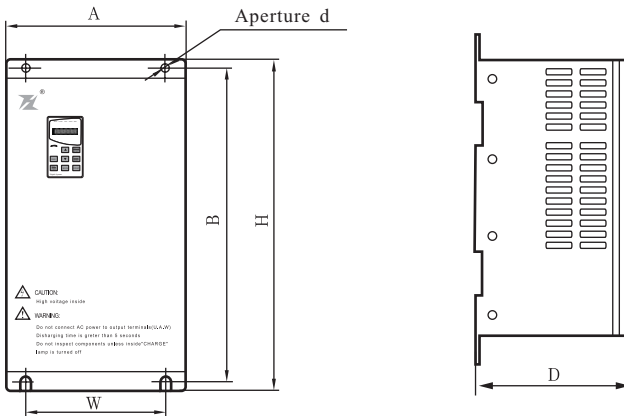

Type 2: Steel Frame (Hanging)

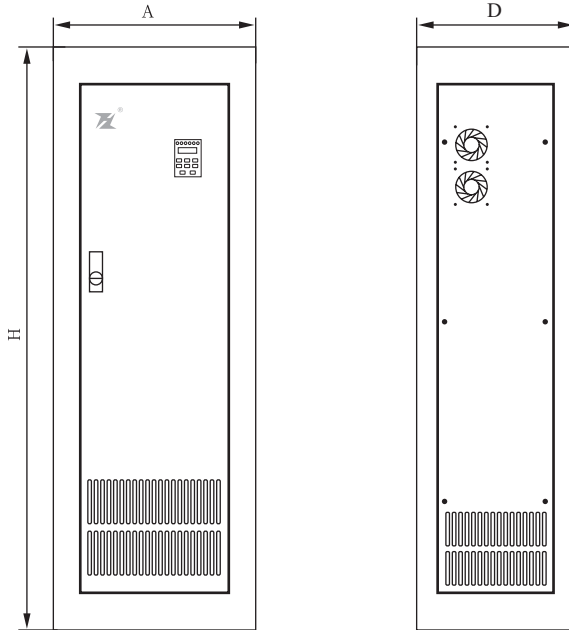

Type 3:Steel Frame (Standing)

Dimension form:

Model	AC Drives Model	Applicable Motor(KW)	Dimensions (mm)					
			A	B	H	W	D	d
FL08	DZB100B0005L2A	0.55	85	131	142	75	113	5
	DZB100B0007L2A	0.75						
FL22	DZB100B0015L2A	1.5	100	141	151	89	117	5
	DZB100B0007L4A	0.75						
	DZB100B0015L4A	1.5						
FL28	DZB100B0007L2A	0.75	125	159	170	113	142	5
	DZB100B0015L2A	1.5						
	DZB100B0007L4A	0.75						
	DZB100B0015L4A	1.5						
FL37	DZB100B0022L2A	2.2	154	238	250	142	155	5
	DZB100B0037L2A	3.7						
	DZB100B0022L4A	2.2						
	DZB100B0037L4A	3.7						
	DZB100B0055L4A	5.5						
FL75	DZB100B0075L4A	7.5	205	300	322	190	193	6.5
	DZB100B0110L4A	11						
	DZB100B0150L4A	15						
FL015	DZB100B0075L4A	7.5	210	358	378	160	205	10
	DZB100B0110L4A	11						
	DZB100B0150L4A	15						
FL030	DZB100B0185L4B	18.5	285	457	475	195	240	9
	DZB100B0220L4B	22						
	DZB100B0300L4B	30						

Model	AC Drives Model	Applicable Motor(KW)	Dimensions (mm)					
			A	B	H	W	D	d
FL045	DZB100B0370L4B	37	315	620	645	230	310	11
	DZB100B0450L4B	45						
FL075	DZB100B0550L4B	55	375	725	750	290	335	13
	DZB100B0750L4B	75						
FL132	DZB100B0930L4B	93	480	860	885	370	335	13
	DZB100B1100L4B	110						
	DZB100B1320L4B	132						
FL160	DZB100B1320L4B	132	535		1480		420	
	DZB100B1600L4B	160						
FL220	DZB100B1870L4B	187	700		1650		470	
	DZB100B2000L4B	200						
	DZB100B2200L4B	220						
	DZB100B2800L4B	280						

AppendixD: Accessories List
1.All Braking Resistors & Braking Units Use in AC Drives

Applicable Motor		Braking Unit Used		Braking Resistors Model No. of Units Used			Braking Torque 10%ED
Voltage	KW (HP)	Model 70BR	NO.	Resistors Values Recommended	Resistors Model	NO.	
220V Series	0.5(0.7)			80W 200Ω	80W 120Ω	1	100%
	0.75(1.0)			80W 200Ω	80W 120Ω	1	
	1.5(2.0)			150W 100Ω	150W 100Ω	1	
	2.2(3.0)			200W 80Ω	200W 68Ω	1	
	3.7(5.0)			300W 50Ω	300W 50Ω	1	
400V Series	0.75(1.0)			80W 400Ω	80W 400Ω	1	100%
	1.5(2.0)			120W 330Ω	180W 300Ω	1	
	2.2(3.0)			160W 250Ω	250W 250Ω	1	
	3.7(5.0)			300W 150Ω	400W 150Ω	1	
	5.5(7.5)			400W 100Ω	600W 100Ω	1	
	7.5(10)			550W 75Ω	800W 75Ω	1	
	11(15)			1000W 50Ω	1000W 50Ω	1	
	15(20)			1500W 40Ω	1500W 40Ω	1	
	18.5(25)	4030	1	2500W 35Ω	2500W 35Ω	1	
	22(30)	4030	1	3000W 27.2Ω	1200W 6.8Ω	4	
	30(40)	4045	1	5000W 17.5Ω	2500W 35Ω	2	
	37(50)	4045	1	9600W 16Ω	1200W 8Ω	8	
	45(60)	4045	1	9600W 13.6Ω	1200W 6.8Ω	8	
	55(75)	4030	2	6000W 20Ω	1500W 5Ω	4	
	75(100)	4045	2	9600W 15Ω	1200W 7.5Ω	8	
93(125)	4045	2	9600W 13.6Ω	1200W 6.8Ω	8		
110(150)	4045	3	9600W 15Ω	1200W 7.5Ω	8		
132(175)	4045	3	9600W 13.6Ω	1200W 6.8Ω	8		

Note:

1. Please only use the resistors and recommended values.

For instance, in 400 V series, 100 HP, AC drive has 2 braking units with each of 8 braking resistors, so two braking units use 16 braking resistors.

(Refer to the "Braking Unit Module User Manual" for further detail.)

2. Take into consideration the safety of the environment when installing the braking resistors.

3. If the minimum resistance value is to be utilized, consult local dealers for the calculation of the Watt figures.

2. Standard Extension Cable:

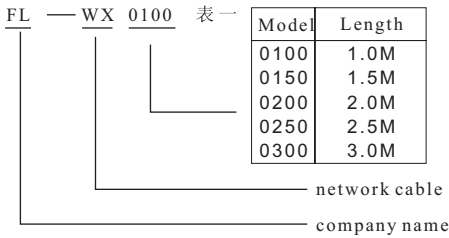

3. The Apparatus Size of the Digital Hand-Held Programming Panel

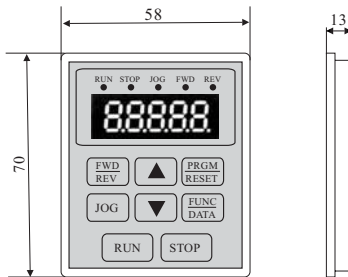
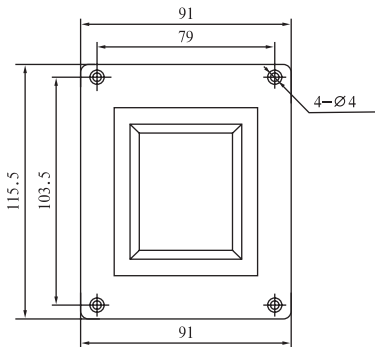

Digital Hand-Held Programming Panel 1

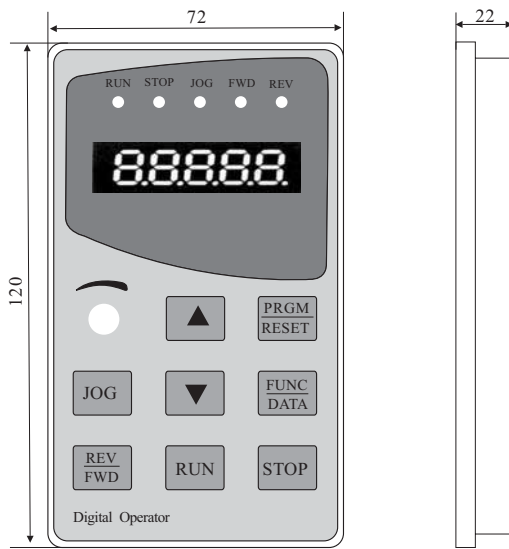

Digital Hand-Held Programming Panel 2