

Read this manual before operation

- The content include of electric connections and operating steps
- Read the manual to operate the systems

# RDC6432G

## Laser cutting engraving control system user manual

### **RuiDa Technology Co., Ltd**

Addr: 202-203,B-Block,Technology Building,NO.,1057 Nanhai  
Avenue,Nanshan District,Shenzhen city,Guangdong  
Province,P.R.China

Tel: 0755--26066687

Fax: 0755--26982287

E-mail: sales@rd-ac.com

Web: www.rd-ac.com



# COPYRIGHT

■ All rights reserved. You may not reproduce, transmit, store in a retrieval system or adapt this publication, in any form or by any means, without the prior written permission of RuiDa, except as allowed under applicable copyright laws. We have identified words that we consider as trademarks. Neither the presence or absence of trademark identifications affects the legal status of any trademarks.

# CERTIFICATION DECLARATION

## CE

The product has been certified by the CE (Communate European) safety certification. It has passed the corresponding conformity assessment procedure and the manufacturer's declaration of conformity, in accordance with the relevant EU directive.

## ROHS

This product has been certified by EU legislation (Restriction of Hazardous Substances) Safety certification; comply with relevant EU environmental regulations.

## FCC

This product has been certified by the Federal Communications Commission for safety, Comply with us electronic safety regulations.

# SAFETY INFORMATION

When using this system, please make sure the operation is correct and the usage is safe. Some signs or text will be used to remind you to pay attention to the dangerous matters and some important information.

**Dangerous:**

Indicates a serious danger. In the process of use, if the operation is improper or the way of use is wrong, it may cause serious injury or even death to the user. Please do not operate it easily until you have made sure that the operation method is correct and the way of use is correct.

**Warning:**

Danger. In the process of use, if the operation is improper or the use is wrong, which may lead to the injury of the personnel, please do not operate the personnel and related personnel easily, until ensure the correct operation method and use method is correct before use.

**Cautious:**

Represents the potential risk of the product. In the process of use, if the use method is wrong or improper operation, it may cause damage to the product or some parts. Please do not use it until you have made sure that the operation method is correct and the usage is correct.

**Important:**

Represents important information to be paid attention to during the use of the product. Please do not ignore this information, this information will provide effective operational help.



This sign indicates laser radiation, which is usually posted on products with laser output. Please be careful with laser and pay attention to safety when using this kind of equipment.

## Sign in、Devanning、Examine cargo

The product itself with plastic or metal shell, can protect the external electrical components from damage. The products are packed in foam bags and anti-static bags. If there is any external damage to the package, check the equipment and notify the carrier and carrier in writing of the damage.

### **Important:**



After receiving the product, please check whether the outer package is intact, check whether the product is complete after unpacking and whether all parts are intact. If any damage is found, please contact ruida immediately.

Remove all cargo from package and keep packing material and wiring parts. Please take care of the safety of the goods when unpacking them. After taking out the goods, please check whether the parts are complete and intact. If any missing parts or damaged parts are found, please contact ruida technology immediately. Do not install or debug the equipment if any obvious damage is found.

# Contents

Section 1	Overview.....	1
1.1	RDC6432G Control System Introduction.....	1
Section 2	Installation dimensions.....	2
2.1	Mainboard installation size.....	4
2.2	Panel mounting dimensions.....	5
Section 3	Physical maps and interfaces.....	6
3.1	Picture of mainboard.....	7
3.2	Picture of panel.....	8
3.3	Control system electrical connection diagram.....	9
Section 4	Mainboard Interface Signal Description.....	10
4.1	Main power connector power.....	11
4.2	Mainboard and display connector HMI.....	11
4.3	Udisk interface.....	11
4.4	PC-USB interface.....	11
4.5	General/dedicated OUTPUT.....	12
4.6	Dedicated/ General input interface INPUT.....	13
4.7	Three-axis limit input interface LIMIT.....	13
4.8	X/Y/U Three-axis drive interface AXIS_X~AXIS_U.....	14
4.9	Laser power control interface.....	15
Section 5	Examples of Laser Power Interface.....	16
5.1	Overview.....	17
5.2	Diagram of glass tube laser power connection.....	18
5.3	RF CO2 laser wiring diagram.....	19
Section 6	Example of Stepper Motor Driver Interface.....	20
6.1	Overview.....	21
6.2	Drive connection diagram.....	22
Section 7	IO Port Wiring Example.....	23
7.1	Input port.....	24
7.2	Output port.....	25
Section 8	HMI operation instructions.....	26
8.1	HMI introduction.....	27
8.1.1	Key function description.....	28
8.1.2	Main interface function.....	29
8.2	Speed Setting.....	30
8.3	Power setting.....	31
8.4	Layer function.....	31
8.5	Menu function.....	32
8.5.1	Jog settings.....	33
8.5.2	Pulse setting.....	34
8.5.3	Axis Reset.....	34

---

8.5.4	Multi-point setting.....	35
8.5.5	Screen origin setting.....	36
8.5.6	Language settings.....	37
8.5.7	Diagnosis.....	37
8.5.8	System Information.....	38
8.5.9	Back up factory parameters.....	39
8.5.10	Restore factory parameters.....	40
8.5.11	Controller management.....	40
8.5.12	Backup to U disk.....	40
8.5.13	Restore parameters from U disk.....	41
8.5.14	Time setting.....	42
8.5.15	Permission Management.....	43
8.5.16	IP setting.....	44
8.5.17	Z-axis stop setting.....	45
8.6	File management.....	47
8.6.1	Memory file.....	47
8.6.2	Array information.....	49
8.6.3	Feeding parameters.....	50
8.6.4	Memory operation.....	50
8.6.5	Format memory.....	51
8.6.6	U disk file.....	51
8.7	Password input and setting.....	52
8.7.1	Password input.....	52
8.8	Prompt and alarm information.....	52
8.9	Parameter setting operation.....	53
8.9.1	Option parameter box.....	53
8.9.2	Number parameter.....	54
8.9.3	Setting parameters from the panel.....	54

# Section 1 Overview

## CONTENTS:

- RDC6432G Control System Introduction



## 1.1 RDC6432G Control System Introduction

RDC6432G system is a laser engraving and cutting control system developed by Ruida Technology. The control system has better hardware stability, anti-high voltage and anti-static characteristics. The HMI system based on 3.5-inch color screen has a more friendly operation interface and more powerful functions. The controller includes complete and excellent motion control functions, large-capacity file storage, an independent and adjustable laser power control interface, compatible U disk driver, multi-channel general/special IO control, and PC communication support USB communication.

# Section 2 Installation Dimensions

## CONTENTS:

- Mainboard installation size
- Panel mounting dimensions

## 2.1 Mainboard installation size

All dimensions are in mm, accurate to 0.1mm (four of the positioning holes are symmetrical)

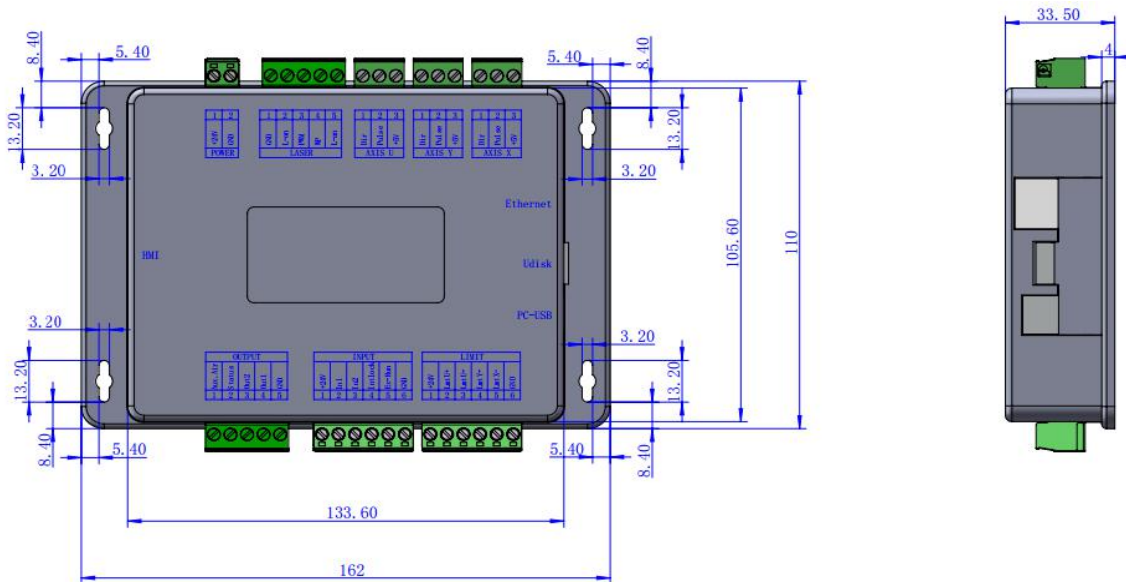

## 2.2 Panel mounting dimensions

All dimensions are in mm, accurate to 0.1mm

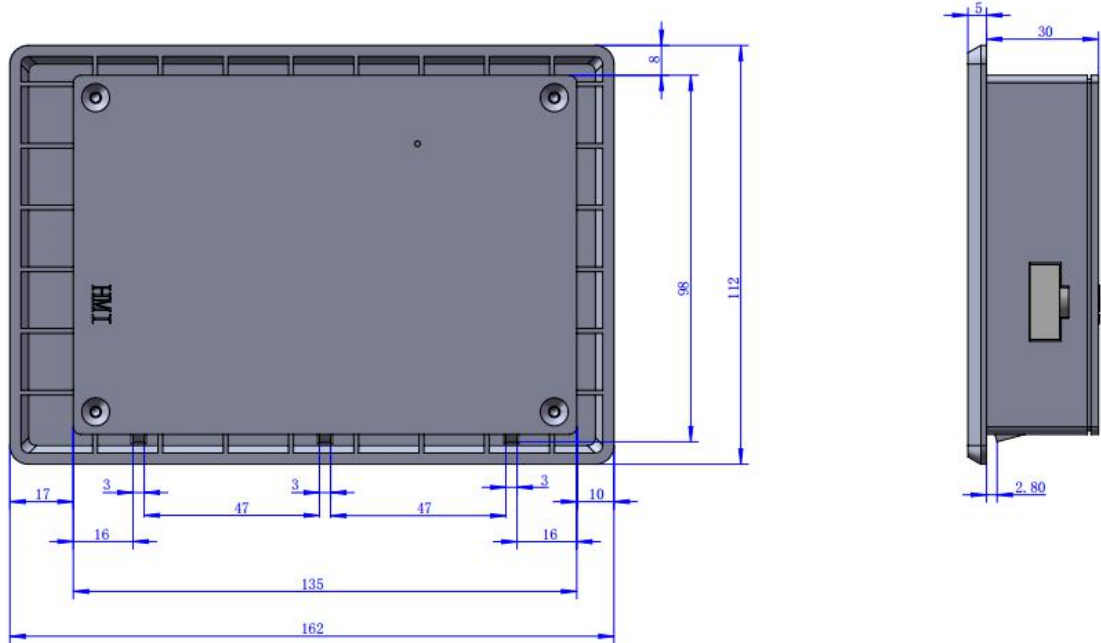

# Section3 Physical maps and interfaces

## CONTENTS:

-  Picture of mainboard
-  Picture of Panel

### 3.1 Picture of mainboard

For more detailed pin description, see Chapter 4 Interface Signal Description.

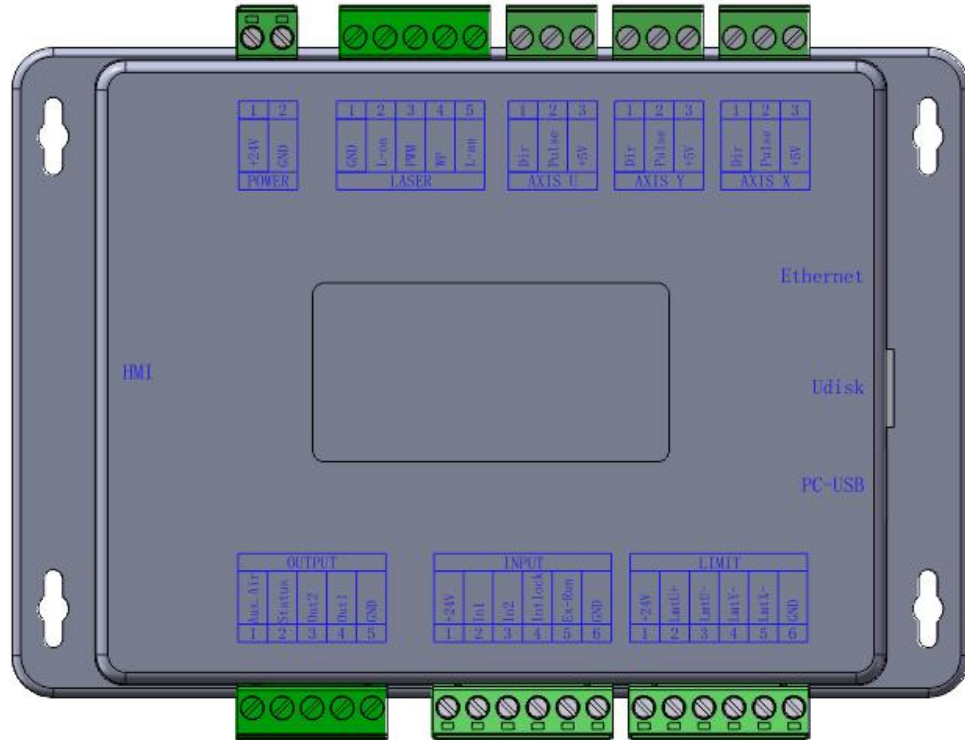

Figure 3.1-1 Picture of Mainboard

### 3.2 Picture of panel



Figure 3.2-1 Picture of Panel

### 3.3 Control system electrical connection diagram

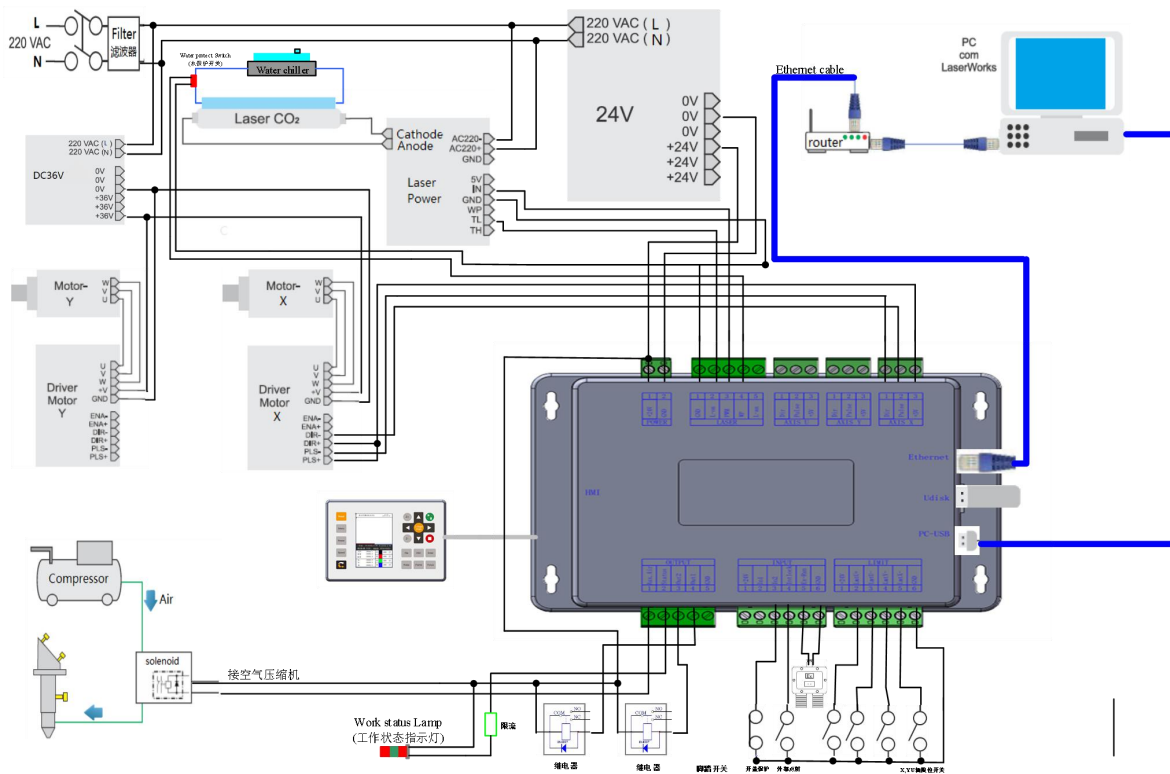

Figure 3.3-1 Control system electrical connection diagram



# Section 4 Mainboard Interface Signal Description

## CONTENTS:

- Main power connector power
- Mainboard and display connector HMI
- Udisk Interface
- PC-USB Interface
- General/dedicated OUTPUT
- Dedicated/ General input interface INPUT
- Three-axis limit input interface LIMIT
- X/Y/U Three-axis drive interface AXIS\_X~AXIS
- Laser power control interface

## 4.1 Main power connector POWER

Pin	Symbols	Definitions
1	GND	24V power ground (input)
2	+24V	24V power positive (input)

 <b>Caution</b>	<p>This control system uses a single 24V power supply. In order to leave a certain margin, it is recommended to choose a power supply of 24V / 2A or more. At the same time, the control system is compatible with 36V power supply, that is, the driver's 36V power can be directly connected to the main power interface of the control system, but this is not recommended.</p>
---	--

## 4.2 Mainboard and display connector HMI

The connection line between the mainboard and the display should be a parallel line of PIN to PIN.

## 4.3 Udisk Interface

U disk is the USB-AM interface, which is the interface for the mainboard to access the U disk.

## 4.4 PC-USB Interface

PC-USB is a communication port that can build up the communication between the controller and the computer. It supports USB2.0 protocol.

## 4.5 General/dedicated OUTPUT

General and dedicated output definition

PIN	Signal	Definition
1	Aux.Air	<p>Dedicated output. When fan control is enabled, this port outputs fan control signal, otherwise it is the first brush control signal. When the fan is connected and the fan control is enabled, the switch of the fan can be set in each layer. If an external relay is connected, the relay coil will be on when the fan is on, and the relay coil will be off when the fan is off.</p>
2	Status	<p>Dedicated output, working status signal port (or the second pen signal). When it is a working state signal, if the port is connected to a relay, the relay coil will be turned on when working, and there will be no effect when the work is suspended. The relay coil will be cut off when the work ends or is cancelled manually.</p>
3	Out2	General output, reserved.
4	Out1	General output, reserved.
5	GND	GND

 <b>Prompt</b>	<p>All output signals are isolated by opto-couplers. OC output, the maximum driving capacity is 300mA, which can directly drive 6V / 24V relay.</p>
--	---

## 4.6 Dedicated/ General input interface INPUT

PIN	Signal	Definition
1	+24V	Power supply + 24V (output)
2	IN1	General input, reserved
3	In2	General input, for a remote laser shot control. When connected to GND, it can perform laser pulse.
4	IntLock	Dedicated input, protection signal input. If the machine needs to be protected in a specific state (such as cover protection), the protection signal is input from this pin. This pin can be enabled and disabled. When the pin is disabled, the signal will not be queried by the mainboard. If the pin is enabled, when the input is high or the input port is floating, the machine is protected, Work in progress will be suspended and the laser will be turned off.
5	Ex-Run	Dedicated input, foot switch input port. The connection method is: when the pedal is stepped on, input a low-voltage signal to the port, when the pedal is released, disconnect the port or input a high-voltage signal to the port; When the pedaling time is not less than 100ms, if the current machine is idle, the work will be started, if the current machine is in the working state, the work will be suspended, if the current machine is in the suspended state, the suspended work will be restarted, namely The function of the foot switch is similar to the "start/pause" key on the keyboard. If the time between the second stepping of the foot switch and the first stepping is less than 100 milliseconds, the second stepping action will be considered invalid by the mainboard.
6	GND	Power ground (output)

## 4.7 Three-axis limit input interface LIMIT

X/Y axis limit interface

PIN	Signal	Definition
1	+24V	Power +24V (output)
2	LmtU+	U+, U axis moves to the limit at the maximum coordinate
3	LmtU-	U-, U axis moves to the limit at 0 coordinate
4	LmtY-	Y-, Y axis moves to the limit at 0 coordinate
5	LmtX-	X-, X axis moves to the limit at 0 coordinate
6	GND	Power ground (output)

The limit polarity is optional. That is, if the motion axis reaches the limit position, a low voltage signal is triggered to make the LED corresponding limit lights up. And the motion axis leaves the limit position, a high voltage signal is triggered or the limit signal connection is disconnected to make When the limit indicator is off, the limit polarity is negative at this time; on the contrary, if the corresponding indicator is off when the motion axis approaches the limit, and the corresponding indicator is on when it leaves the limit, the limit polarity is positive. If the limit polarity is set incorrectly, the limit will not be detected when the system is reset, resulting in axis collision.

**XYU axis limit input port is compatible with 5V/12V/24V logic level input.**

## 4.8 X/Y/U Three-axis drive interface AXIS\_X~AXIS\_U

The three motion axis interfaces are the same. Take the X axis interface AXIS\_X as an example.

PIN	Signal	Definition
1	DIR	Direction signal terminal (OC output)
2	PUL	Pulse signal terminal (OC output)
3	+5V	+5V power supply ( output, only for driver common anode connection )

The direction signal polarity of the driver can be set. If an axis moves in the opposite direction of the machine origin when reset, it means that the direction signal polarity of the axis is incorrect. At this time, the connection between the axis and the motor driver can be disconnected (otherwise the mainboard cannot detect the limit, which may cause The axis collides), and then wait until the axis reset is completed, then correct the direction signal polarity of the axis, and then press the reset button to reset the main board after the modification is completed.

Drive pulse signal may be provided rising or falling edge, default is falling edge.

 <b>Prompt</b>	<p>The pulse signal and direction signal are both OC output, so the controller and motor driver must use the common anode connection method. Common cathode and differential connection methods are not supported.</p>
--	--

## 4.9 Laser power control interface

PIN	Signal	Definition
1	GND	Laser power ground (output) Laser enable control interface 1. When the laser is a RF laser, this pin is reserved
2	L-ON	2. When the laser is a glass tube, if the laser power is low-voltage output, then this pin is connected to the laser power laser enable end to control the laser on/off; high- voltage laser power is not supported. Laser/tube power control interface
3	LPWM	1. When the laser is a RF laser, this pin is connected to the laser RF-PWM terminal. 2. When the laser is a glass tube, this pin is connected to the PWM end of the laser power supply to control the power of the laser.
4	WP	The first laser power supply water protection status input port. When the water protection 1 is enabled, the main board will detect the water protection 1 input port. If the port is in low-voltage, it is normal. If the port is in high-voltage, the mainboard will force the laser to be turned off, and the ongoing work will Pause, and the system will alarm at the same time. If water protection 1 is not enabled, the mainboard will not detect the water protection 1 input port, at this time the user cannot connect the water protection 1. <b>The water protection input port must use 24V logic level input.</b>
5	L-AN	Laser power analog signal output. If it is a glass tube laser power supply, this pin is recommended for the power signal.



Prompt

Please select the correct laser type in the factory parameter settings.

# Section 5 Examples of Laser Power Interface

## CONTENTS:

- Overview
- Diagram of glass tube laser power connection
- RF CO2 laser wiring diagram

## 5.1 Overview

This control system has two independent and adjustable laser power control interfaces, which can control the glass tube laser power and RF CO2 laser.

**When connecting different laser power types, please set the laser type correctly in the manufacturer's parameters, otherwise it may cause the laser fire to be incorrect.**



## 5.2 Diagram of glass tube laser power connection

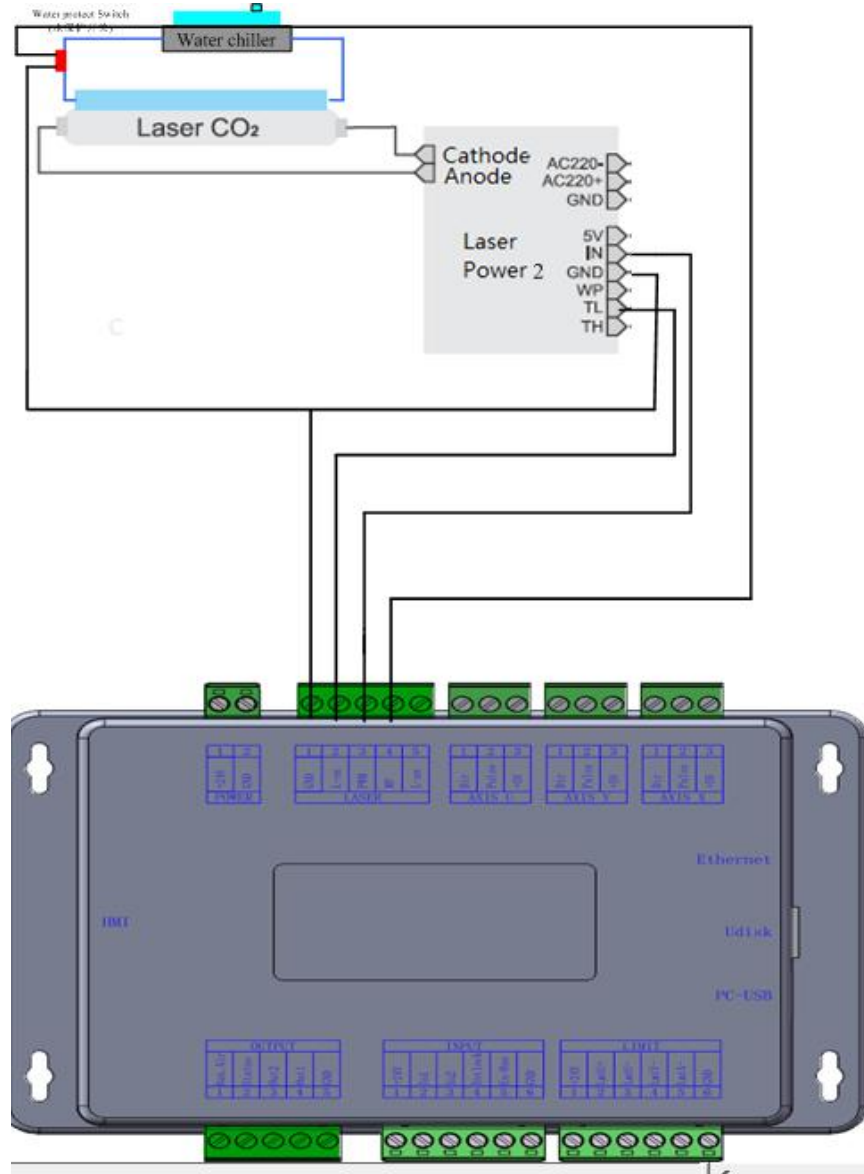

Figure 5.2-1 Example of glass tube laser connection

### 5.3 RF CO2 laser wiring diagram

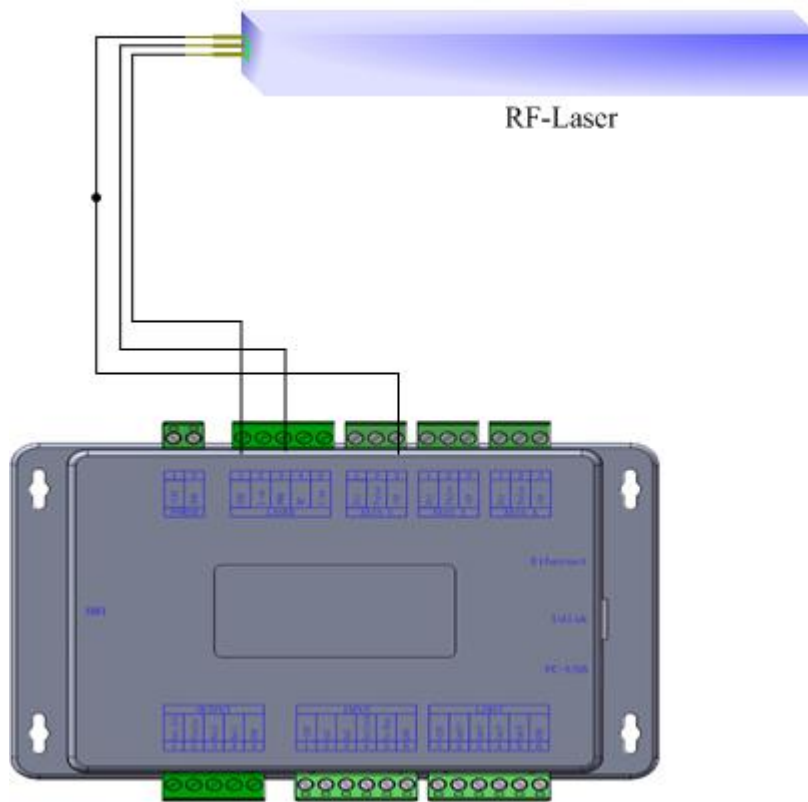

Figure 5.3-1 Example of RF CO2 laser connection

# Section 6 Example of Stepper Motor Driver Interface

## CONTENTS:

- Overview
- Drive connection diagram

## 6.1 Overview

The input signal end of the stepper motor driver adopts optocoupler isolation technology. For stepping pulse signals, some of the isolation side optocoupler diodes from cut-off to conduction (that is, the falling edge of the pulse signal input from the negative end of the diode is valid), And some are the isolation side optocoupler diode from on to off (that is, the rising edge of the pulse signal input from the negative end of the diode is valid).

**When the pulse signal of the motor driver is valid at the rising edge or the falling edge, the pulse signal input from the negative terminal of the photocoupler diode on the isolation side shall prevail.**

Some of the motor driver input signals are independent, and some are internal common anodes, so some of the outgoing lead wires are 4, and some are 3 (only counting pulse and direction signals), as shown in Figure 6.1-1 and Figure 6.1-2 .

Each motor driver interface of RDC6432G mainboard provides a direction signal, a pulse signal, and a 5V signal for common anode connection. The pulse signal and direction signal are both OC output.

**RDC6432G only supports common anode connection, and cannot use common cathode or differential connection. Among them, the polarity of the direction signal can be set by the PC, and whether the pulse signal is valid at the rising edge or the falling edge can also be set by the PC.**

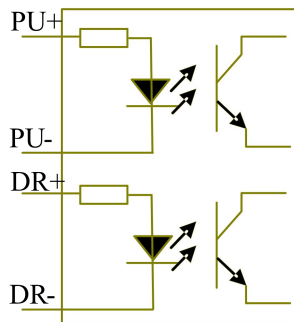

Figure 6.1-1 Four inputs, independent drive input signal

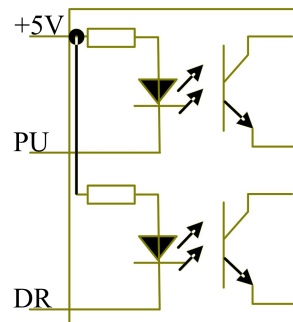

Figure 6.1-2 Three inputs, drive input signal common anode

## 6.2 Drive connection diagram

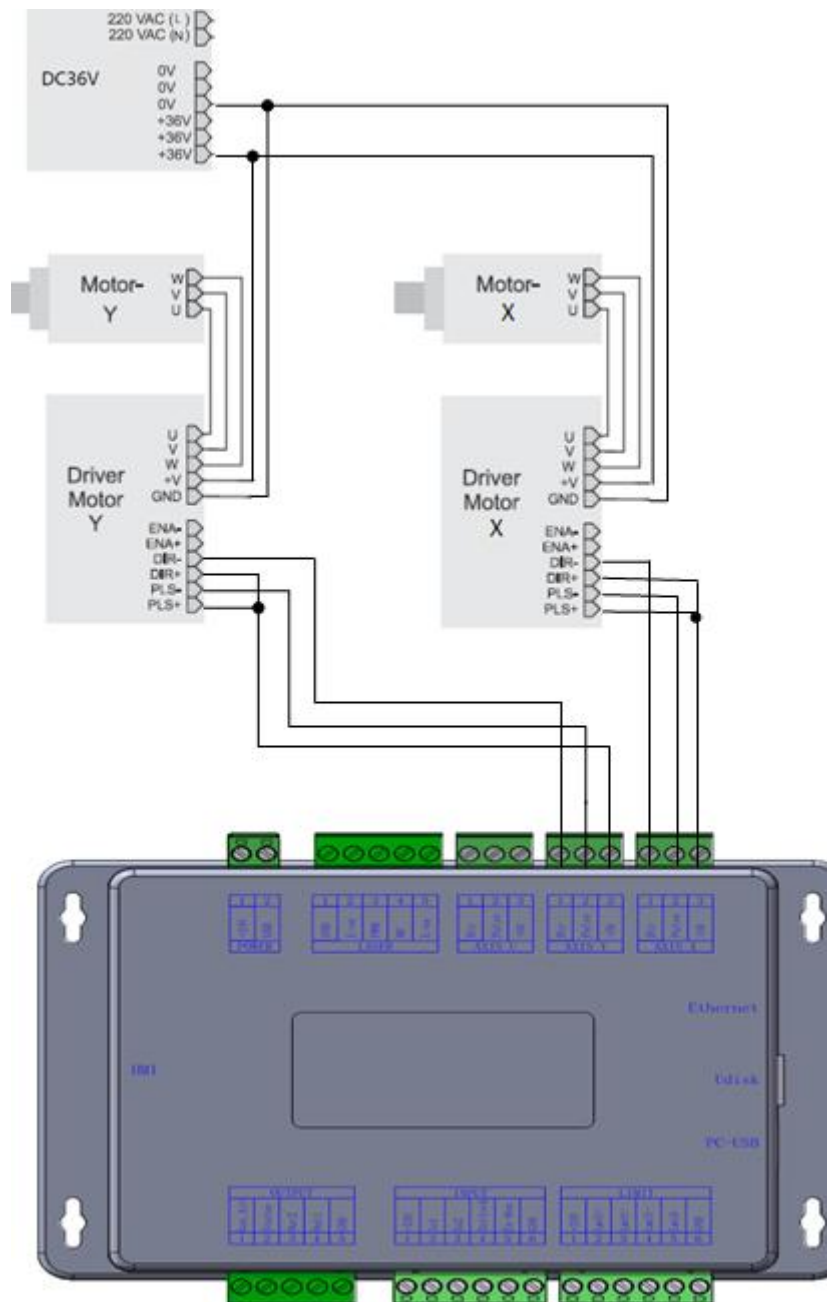



Figure 6.2-1 Example of driver connection

# Section 7 IO Port Wiring Example

## CONTENTS:

-  Input port
-  Output port

## 7.1 Input port

The water protection input port WP of this controller is only compatible with 24V. All other input ports are compatible with input 5V / 12V / 24V.

The wiring diagram of the input port is as follows:

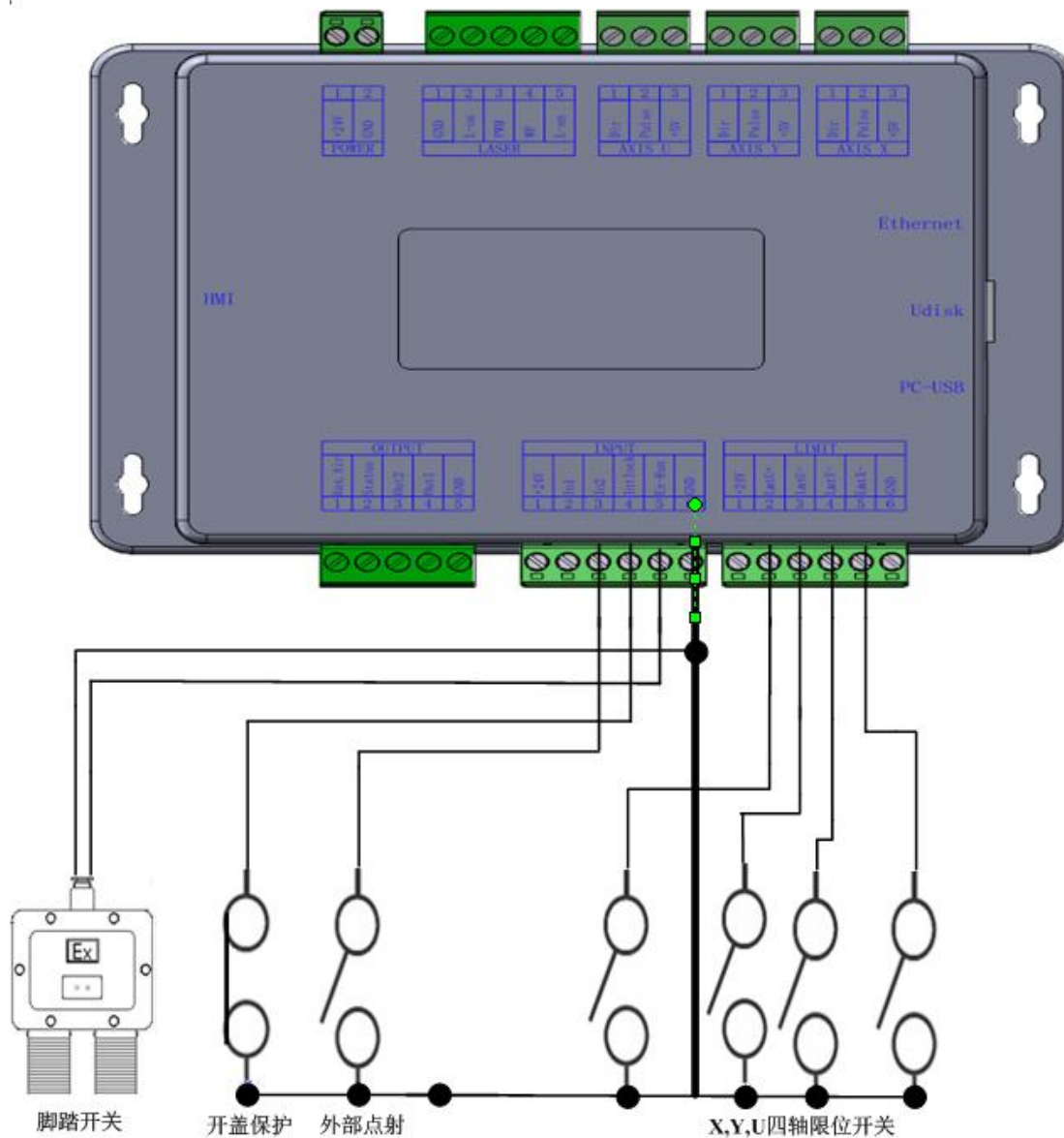

Figure 7.1-1 Example of input

## 7.2 Output port

All output signals of this controller are output based on opto-coupler isolation technology and OC gate output. Its maximum driving capacity is 300mA, which can directly drive 6V / 24V relays, light-emitting indicators, buzzer alarm devices, etc. If user wants to drive valve, a relay is strongly recommended to be added between the controller and the valve.

The output wiring diagram is as follows:

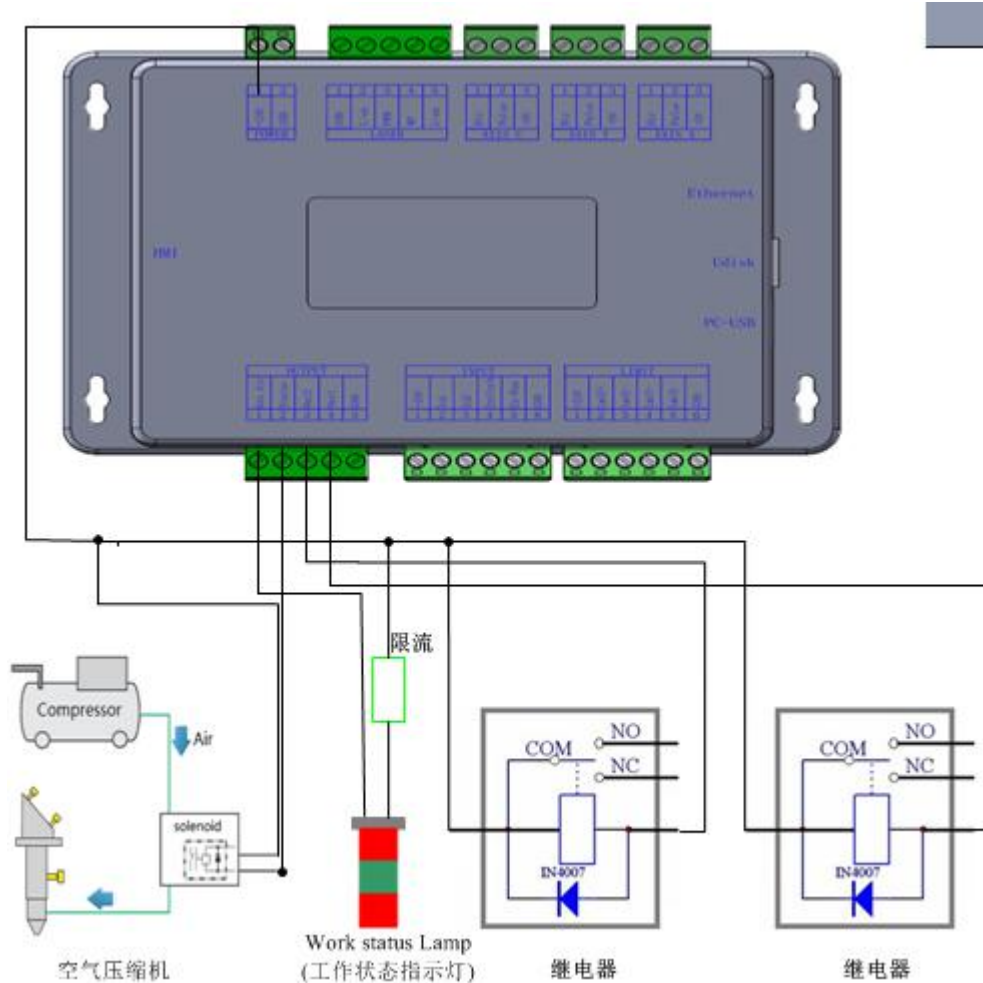

Figure 7.2-1 Example of output connection



# Section 8 HMI operation instructions

## CONTENTS:

- HMI introduction
- Speed Setting
- Power setting
- Layer function
- Menu Function
- File management
- Password input and setting
- Prompt and alarm information
- Parameter setting operation

## 8.1 HMI introduction

RDC6432G-HMI panel (hereinafter referred to as "panel") is a HMI based on 3.5TFT LCD screen, with beautiful interface, friendly, smooth control, high cost performance. The panel can depict the motion track of the controller in real time, allowing users to see the current processing graphics clearly, support file management, file preview, parameter modification, support multi-language interface switching and other functions.

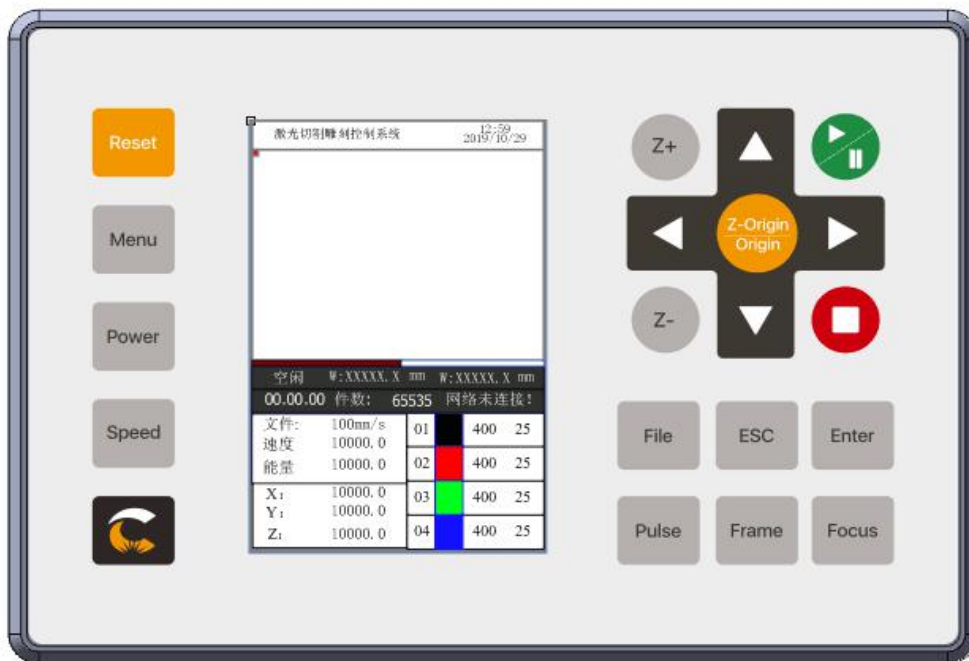

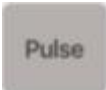

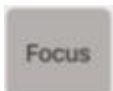
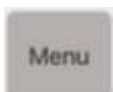
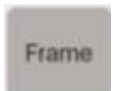
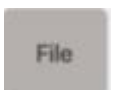





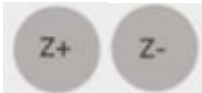
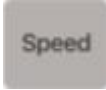

Figure 8.1.1-1 Panel image

Panel characteristics:

- 3.5-inch TFT
- 320×480 Resolution
- 64K color
- RS232 Standard communication
- Buzzer

## 8.1.2 Key function description

-  "RESET": Reset system
-  "RUN/PAUSE": Start job or pause / restart job
-  "PULSE": Laser tube pulse (Note: Press 'Shift '+'Pulse' for continuous pulse)
-  "STOP": Stop processing/Motor axis movement
-  "FOCUS": Auto Focus
-  "MANU": User parameters, manufacturer parameters, language settings etc.
-  "FRAME": Perform border operation on the current processing file
-  "FILE": Memory file and U disk file management
-  "Origin" : Set the positioning point (Note: Press and hold 'Shift' + 'Z-Origin' to set the current coordinate of the Z axis as the focus point)
-  "ESC": Used to return to the previous menu, cancel parameter settings, etc.
-  "ENT": Enter
-  Arrow keys: used to move the X axis and Y axis or to move options when setting parameters in the menu, adjust the value size, etc. (Note: Press and hold 'Shift' + 'X, Y' to switch to fast movement mode)

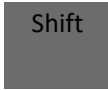
-  Z axis: used to move the Z axis (Note: press and hold 'Shift' + 'Z+' to return to the Z axis focus point)
-  Speed : used to set the speed
-  Shift : use the switching function with other keys 

## 8.2 Main interface function

When the system is reset after power on, the main interface will be displayed. As shown below:

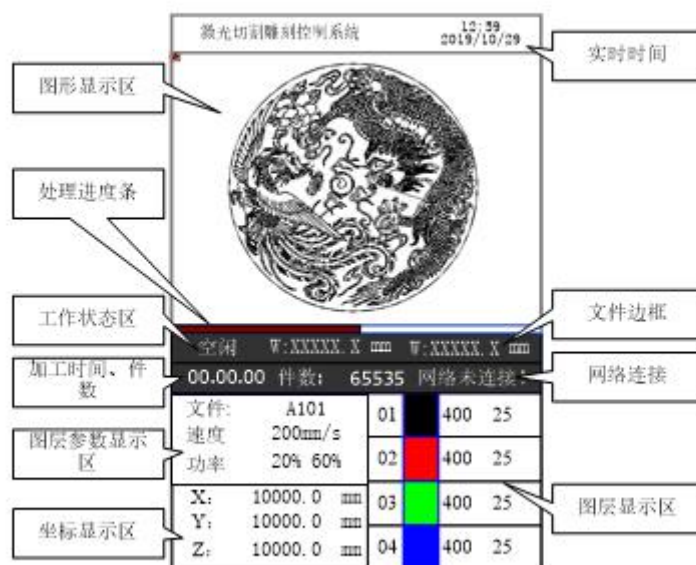

Figure 8.2.2-1 Main interface display example

- Graphic display area: This area is used to trace the processed file image during file preview display and processing.
- Processing parameter display area: Display the file number, speed and maximum power of the current processing file.
- Coordinate display area: Display the coordinate value of the current position of the laser head

- Layer parameter area: Display the layer parameters of the current processing file or the layer parameters of the preview file. The parameters from left to right are: layer color, layer speed, and layer maximum power.
- Working status area: Used to display the current working status of the system, which are idle, paused, completed, running. The processing time is displayed on the right.
- Processing progress bar: Display the current processing progress
- Number of pieces: Display the processed quantity of the current processing file.
- Frame size of processing file: The range of the processing file is displayed.
- Version number: Program version number for panel and motherboard.
- System time: Display the current system time

In the completed / idle state, the keys can respond, and users can perform file processing, parameter setting, file preview and other operations.





In the running / pause state, some keys do not respond, such as positioning key, border key, file key, etc.

### 8.3 Speed Setting

Press the [Speed] key in the main interface, and the following interface will pop up:



Figure8.2-1

1. Press [Enter] to confirm the editing of this parameter box, as shown in the figure above, you can modify the underlined number. Press the key  on the panel to move the underline of the value to the left, and press the key  on the panel to move the underline of the value to the right.
2. Press the key  on the panel to increase the value, press the key  on the panel to decrease the value ( “1” is selected in the figure above, and only “1” can be modified at this time).

3. After setting, press [Enter] to save the modified parameters, and press [ESC] to exit the interface.







## 8.3 Power Setting

Press [Power] key in the main interface, the following interface will pop up:

最大功率:  %  
 最大功率:  %

按<确定>键设置参数

Figure 8.3-1

1. As shown in the figure above, press   on the panel to select the input box parameters which need to be modified. The selected input box will change from black to red.
2. After selecting, press [Enter] key to modify the underlined number. Press the key  on the panel to move the underline of the value to the left, and press the key  on the panel to move the underline of the value to the right.
3. Press the key  on the panel, the value becomes larger, press the key  on the panel, the value becomes smaller (the "0" is selected in the figure above, and only "0" can be modified at this time)
4. After setting, press [Enter] to save the modified parameters.
5. If you need to set other input box parameters, repeat step 1, and press [ESC] to exit this interface.

## 8.4 Layer function

When the systems is completed / idle in the main interface, if there is layer information in the layer parameter area, as shown below:

	100	99.9%
	100	99.9%
	100	99.9%
	100	99.9%

Figure 8.4-1

Press [ENT] to enter the parameter area. Use the up and down arrow keys to select the layer parameter

area. At this time, the "red selection box" appears in the first line of the layer list, as shown in the figure below:

	100	99.9%
	100	99.9%
	100	99.9%
	100	99.9%

Figure 8.4-2

User can press the up and down keys to select the layer number, and the "select block" will also move. Select the layer number to be modified and press [ENT], the layer setting interface will pop up, as shown in the figure below:

图层0:           

速度:  mm/s

最小功率:  %

最大功率:  %

按<确定>键修改  
按<退出>键返回上级菜单

Figure 8.4-3

Please refer to section 8.9.3 for parameter setting operation. Press **【ESC】** key to exit the interface and return to the main interface.

## 8.5 Menu Function

Press [Menu] in the main interface, the pop-up menu interface is as follows:

点动设置	系统信息
点射设置	备份出厂参数
各轴复位	恢复出厂参数
多定位点设置	控制器管理
屏幕原点设置	授权管理
语言设置	IP设置
诊断	Z轴停靠点设置

Figure 8.5-1

Press the panel direction keys ▲, ▼, ◀, ▶ to select the parameter to be set, the selected parameter box will change from black to red. Press [Enter] key to enter the Submenu, and press [ESC] key to return to the previous menu.

## 8.5.1 Jog settings

When the "red selection box" stops on the item and press the [Enter] key, the following interface will pop up:

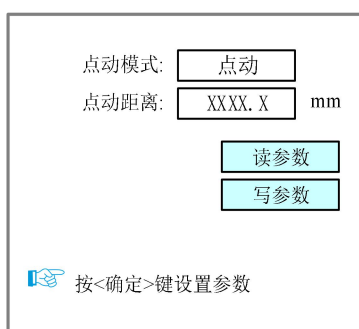

Figure 8.5.1-1

1. As shown in the figure above, press the key ▲ ▼ on the panel, select [Read], and press the [Enter] key (the selected input box will change from black to red).
2. Select [Jog Mode], press [Enter] to enter the setting state, press ▲ ▼ to select "Jog" or "Continuous" mode, after setting, press [Enter] to save the modified parameters.
3. Press the key ▼ on the panel, select "Jog distance", press the [Enter] key, press ◀ ▶ to move the underline, press the key ▲ to make the underline value larger; press the button ▼ on the panel to make the underline value smaller.
4. After setting, press [Enter] to save the modified parameters.
5. Finally select [write and press [Enter] to save the modified parameters, and press [ESC] to exit this interface.

When the jog mode is "continuous", the jog parameter has no effect. When returning to the main interface, press the direction key, the axis moves, and when the direction key pops up, the axis stops moving. When the jog mode is "Jog", the corresponding motion axis will run once every time you press the direction key, and run distance is equal to the jog distance value set by the user (in the case of not exceeding the machine format).



## 8.5.2 Pulse setting

When the "red selection box" stops on the item and press the [Enter] key, the following interface will pop up:

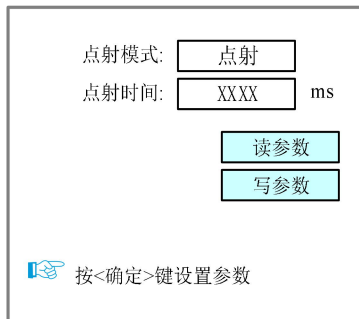

Figure 8.5.2-1

Please refer to section 8.5.1 for setting steps.

If the pulse mode is selected as "continuous", the laser will always on when the pulse button is pressed, and the laser will be turned off when the start button is ejected. If the pulse mode is selected as "pulse", the laser will be on once every time the pulse button is pressed. The laser time is the pulse time value set by the user.

## 8.5.3 Axis Reset

When the "red selection box" stops on the item and press the [Enter] key, the following interface will pop up:

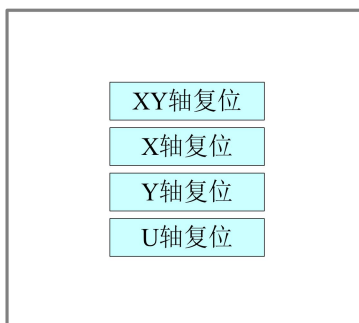

Figure 8.5.3-1

Press the arrow keys ▲ ▼ , select an item and press [Enter] key, the system will reset the axis and prompt "Resetting..."

Press 【ESC】 key to return to the previous menu.

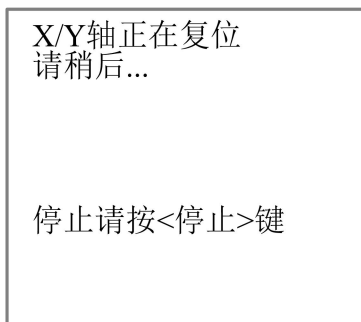

Figure 8.5.3-2

## 8.5.4 Multi-point setting

In the menu interface, select the "positioning Settings" item, press [Enter] key and then the following interface will pop up:

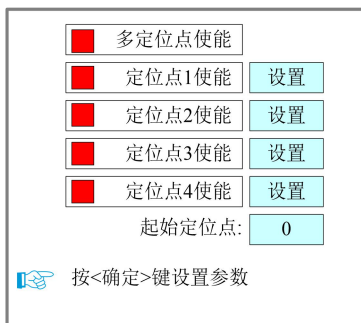

Figure 8.5.4-1

At this time, the "red selection box" defaults to the "multi point enable" item, press the [Enter] key to enable or disable multiple points (the small square on the right is displayed in red  多定位点使能 when enabled), and other point operations are same, just enable the point that needs to be used. After each position point is enabled, there is a **【Set】** button. When you need to set the corresponding position of the positioning point, just use the "Up, Down, Left, Right" keys to select the red selection box corresponding to the positioning point **【Set】** button, and press the **【Enter】** then enter the positioning point position setting interface, as shown in the figure:

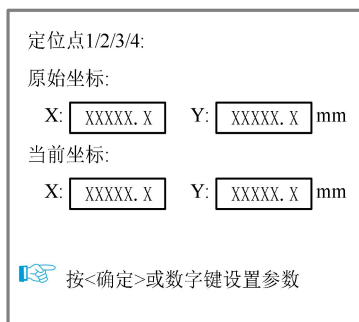



Figure 8.5.4-2

Press the up, down, left, and right keys to move the X or Y axis to the target position. After pressing the [Origin] key, the original coordinates will become the current coordinates. Press [ESC] to exit the interface and the parameters will take effect automatically, and then press the [ESC] key to return to the previous menu.

The setting methods of other points are the same as above.

Each sub-item is introduced as follows:

- Multiple positioning enable: "Yes" and "No" are optional. When "No" is selected, the system uses single point logic. Press the "Origin" key on the keyboard to set the positioning, and this point takes effect. When "Yes" is selected, the system uses multi-point logic and the "Origin" key on the keyboard is invalid. The value of each point needs to be set in the menu, see below.
- Start positioning point: 0~4 is optional, it displays the positioning point to be used for the next picture to be worked. No. 0 anchor point indicates the anchor point set by the "Origin" key on the panel in the single point logic, and 1~4 indicate the anchor point serial number in the multiple point logic. The next point can be modified to any point from 1 to 4, so as to control the starting point of the next work (provided that the anchor point is enabled), and cannot be modified to the 0 anchor point (if it is a single point logic, always take No. 0 point).
- Positioning points 1~4 enable: When the multi-positioning point logic is enabled, the four positioning points can be individually disabled and enabled.

 Prompt	Once the multi-point logic is selected, assuming that the initial positioning point number is 1, and all four positioning points are enabled, when the memory file is started (including keyboard startup and PC startup), or when the PC uses direct output to start the work and When the option "Use the original anchor point as anchor point" is selected, a different anchor point will be used each time the job is started, and the rotation sequence of anchor points is 1->2->3->4->1->2..... . If the PC uses the direct output to start the work, when the "current point is the anchor point" is selected, the system always uses the current point as the anchor point.
---	---

## 8.5.5 Screen origin setting

When the "red selection box" stops on the item and press the [OK] key, the following interface will pop up:

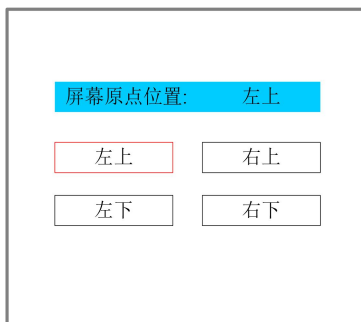

Figure 8.5.5-1

Set the origin position of the display screen here, and select different screen origin positions to mirror the displayed graphics in different X/Y directions.

Press the arrow keys to select a position and then press the [Enter] key, the screen origin position will be displayed as the currently selected position, press [ESC] to return to the main menu interface.

## 8.5.6 Language settings

When the "red selection box" stops on the item of [language setting] and press [Enter] key, the following pops up :

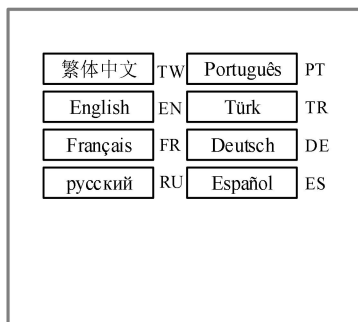

Figure 8.5.6

Press the arrow keys to select a language and press the [Enter] key, the setting takes effect, and then it automatically returns to the main interface.

## 8.5.7 Diagnosis

When the "red selection box" stops on the [diagnosis] item and press the [Enter] key, the following interface will pop up:

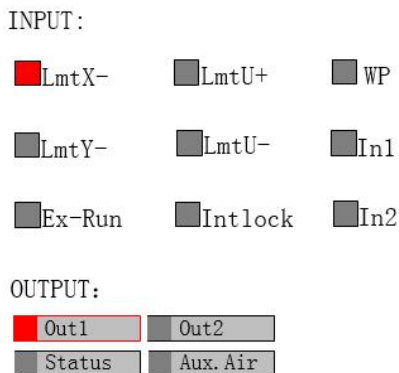

Figure 8.5.7-1

This interface displays the hardware IO port information of the system: ■ trigger ■ Not triggered

Input signal:

Read system hardware information. When the hardware signal is triggered, the small box on the left of the corresponding item will be red, otherwise it will be gray.

Output signal:

Select an output port with the cursor and press [Enter] to switch the output state.

Press **【Exit】** to return to the previous menu.

## 8.5.8 System Information

Choose “System info” option and press the [ENT], fill in “RD8888” and confirmed, the following interface pops up:

密码:

0	1	2	3	4	5	6	7	8	9
A	B	C	D	E	F	G	H	I	J
K	L	M	N	O	P	Q	R	S	T
	U	V	W	X	Y	Z			

按方向键选择密码，按<确定>键选中

Figure 8.5.8-1

1. Use the arrow keys to select numbers or letters, and press [Enter] to confirm.



## 8.5.10 Restore factory parameters

In the menu interface, select the "Restore default", and press the [ENT] key to pop up the password input interface, fill in "HF8888". If the password is entered correctly, the system will restore all current user parameters and vendor parameters with the factory parameters that were set before. The interface prompts "Restored success."

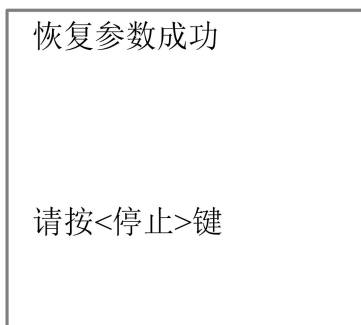

Figure 8.5.10-1

## 8.5.11 Controller management

Choose the "controller set" and press [ENT], the following interface pops up:



Figure 8.5.11-1

Press [Enter] on the corresponding item to read and execute the corresponding functions, and press [ESC] to return to the previous menu.

## 8.5.12 Backup to U disk

When the "red selection box" stops on the item, press [Enter] key, the following interface will pop up:



Figure 8.5.11-2

If there is a problem with the U disk, it will prompt "Parameter backup failed".



Figure 8.5.11-3

### 8.5.13 Restore parameters from U disk

When the "red selection box" stops on the item, press [Enter] and enter the password. Please refer to section 8.5.8 for the password input operation, the following interface will pop up:

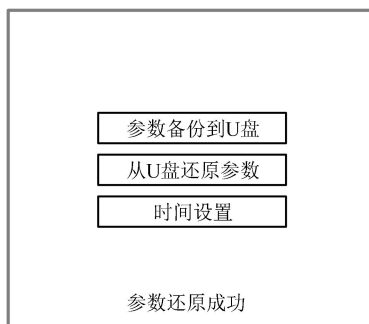

Figure 8.5.11-4

If there is a problem with the U disk or the parameters are not backed up, it will prompt "parameter file does not exist"





Figure 8.5.11-5







## 8.5.14 Time setting

When the "red selection box" stops on the item and press the [Enter] key, the following interface will pop up:



Figure 8.5.11-6

This interface can only be displayed when the system is not encrypted. The parameter setting steps are as follows:

1. Press the arrow keys to select the entry date or time, and press [Enter] to enter the setting.
2. Press   the arrow keys to move the underline under the number, such as: 2019, press the key  on the panel, the underline of the value moves to the left, press the key  on the panel, and the underline of the value moves to the right.
3. Press the key  on the panel, the underline value becomes larger. Press the key  on the panel, the underline value becomes smaller. (Only modify the underlined numbers)
4. After setting the current input box, press [Enter] to save the setting, repeat steps 1, 2 and 3 to continue

to modify.

5. After all modifications are completed. Select the item [write], press [Enter] to save the parameter settings, and press [ESC] to return to the previous menu interface.

### 8.5.15 Permission Management

The product should be authorized if users are the first time to choose RUIDA

If the current product is not authorized, choose the option of "Permission", press [ENT] and the following interface pops up:

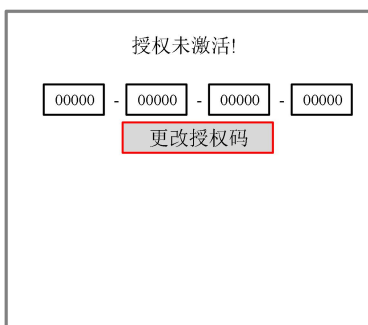

Figure 8.5.12-1

2. Select [Change Authorization Code] in the red selection box and press [Enter] to enter the following interface.

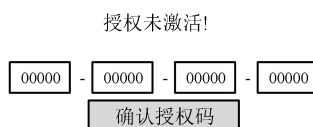

Figure 8.5.12-2

3. The red selection box selects the first parameter box, and then press [Enter] again to display the soft keyboard, as shown in the figure below:

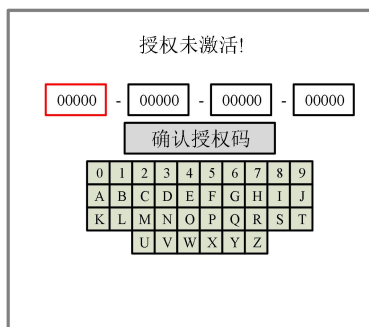

Figure 8.5.12-3

4. Use the "up, down, left, and right" direction keys to select the corresponding character, and press [Enter] to confirm the input. If you make a mistake in the operation, just press [Exit] to reselect and press [Enter] to enter the setting.
5. After input, press 【ESC】 key to exit the current input box setting, and the soft keyboard will disappear. Press the arrow keys to select other parameter boxes. The parameter setting operation is the same as above.
6. After setting all parameters, move the red selection box to [Change Authorization Code], and press [Enter] to set successfully.
7. If the authorization code is wrong, prompts such as "non-compliant authorization code" or "authorization is not activated, setting is invalid", "authorization code does not match" will be displayed.

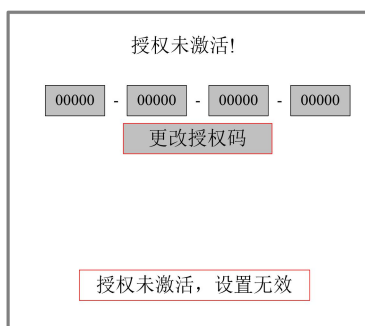

Figure 8.5.12-4

8. If the authorization code is correct, it will prompt authorization activation. Press the exit key to return to the upper operation interface.

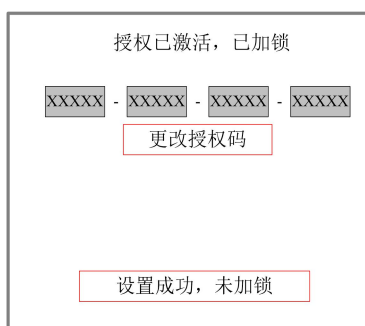

Figure 8.5.12-5

## 8.5.16 IP setting

When the "red selection box" stops on the [IP settings] item and press the [Enter] key, the following interface will pop up

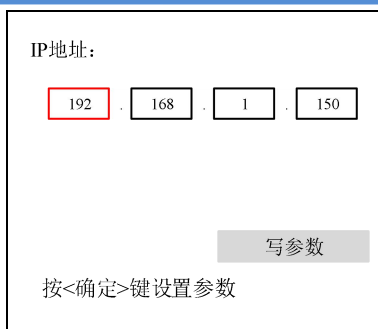



Figure 8.5.13-1

2. Use the arrow keys  to select the item to be set, the red box is the selected item, as shown in the figure below, press [Enter]:

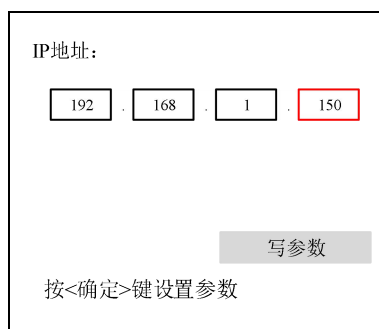





Figure 8.5.13-2

3. After pressing the [Enter] key, an underline will be added to the number of the item. Users can use the arrow keys  to move the underline 150, press the key  to increase 160 the value of the underline, and press the key  to reduce the underline value 140.

4. After setting is completed, press [Enter] key to save the settings of the current entry, and repeat the above steps if you need to set other entries.

5. All items are set up, select [write parameters], press [Enter] key to save all item settings.

6. Press [ESC] key to return to the main menu interface.

## 8.5.17 Z-axis stop setting

When the "red selection box" stops on the [Z-axis origin point setting] item and press the [Enter] key, the following interface will pop up:

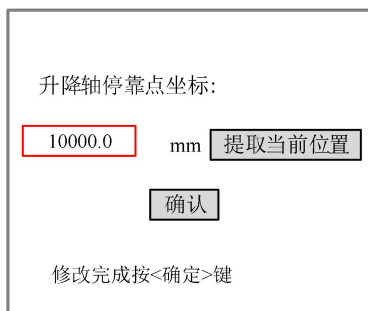



Figure 8.5.14-1

There are two ways to set the Z-axis point, one is to directly input the Z-axis coordinate, and the other is to set the current coordinate position.

### Enter the Z coordinate

1. As shown in the figure below, select the input box with the arrow keys , and press [Enter] to enter the editing state.

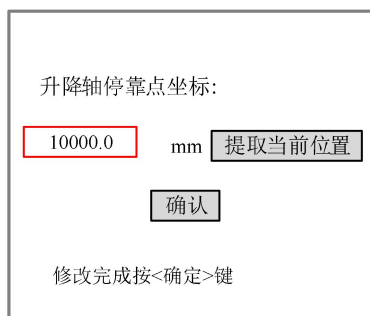





Figure 8.5.14-2

2. An underline will be added to the number in this entry. Users can move the underline with the arrow keys , and press the key  to increase the value of the underline, and press the key  to reduce the value of the underline.

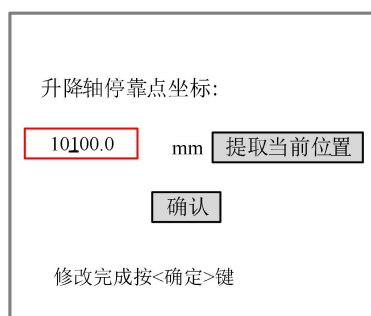

Figure 8.5.14-3

3. After setting, press [Enter] key to save the setting of this input box.

4. Press [Enter] on the panel to save the settings.

5. Press **【ESC】** key to return to the main menu interface.

### Current location

1. As shown in the figure below, use the arrow keys, to select [current location], and press [Enter] to get the current location.

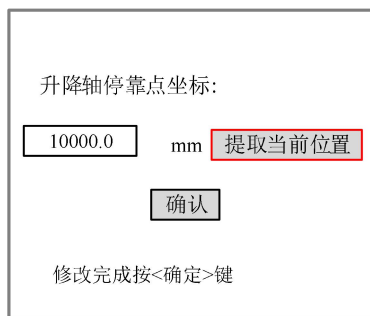

Figure 8.5.14-2

2. Press [Enter] on the panel to save the settings.
3. Press 【ESC】 key to return to the main menu interface.

Note: Before getting the current position, users can move the Z axis to the desired position, and then enter this menu to set the Z axis origin point.

## 8.6 File management

### 8.6.1 Memory file

In the main interface, press [File] to pop up the following interface:

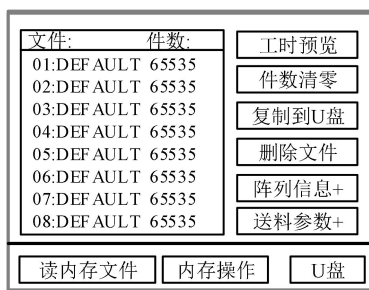

Figure 8.6.1

After entering this interface, the controller will automatically read the system memory file. The first column is the file name. The second column is the copies that have been processed. When a file is selected and confirmed, the file will be displayed in the preview area. When there are multiple files, press the up and down keys to select a file, the file will be previewed, and the graphic will be displayed in the upper right of the interface. After pressing [ENT], the file will be previewed on the main interface, and the current file dialog box will be closed. If you want to cancel the preview, press [Esc].

Press the left and right keys to switch the activated area with a blue square between the file list on the left and the item on the right, indicating that the list or item is activated. When the "red selection box"

stops on the item, press the up and down keys to select the item and press [ENT] to select the item.

Press [Esc] to return to the main interface.

The contents of the entries on the right and bottom are as follows:

- Work time check: The total processing time of the file is predicted, and the difference between the predicted time and the actual running time is only milliseconds.
- Clear processed copies: Clear the number of processed pieces of the selected file.
- Copy to U disk: Copy the selected file to U disk.
- Delete file: delete the selected file.
- Feeding parameter: enter the feeding parameter setting.
- Array information: enter the array information parameter setting.
- Read memory file: read the memory file list.
- Memory operation: Enter the lower-level menu of memory operation.
- U disk: U disk file menu.

Main steps:

1. Press **【File】** to enter the main file interface, and use ▲ ▼ keys to select the file to be edited, as shown below:

文件:	件数:
01:DEF AULT	65535
02:DEF AULT	65535
03:DEF AULT	65535
04:DEF AULT	65535
05:DEF AULT	65535
06:DEF AULT	65535
07:DEF AULT	65535
08:DEF AULT	65535

Figure 8.6.1-1

2. After selecting, press the key ▶ to make the selection box to the editing area on the right, and press ▲ ▼ keys to select operation, as shown in the figure below :

文件:	件数:	
01:DEF AULT	65535	工时预览
02:DEF AULT	65535	件数清零
03:DEF AULT	65535	复制到U盘
04:DEF AULT	65535	删除文件
05:DEF AULT	65535	阵列信息+
06:DEF AULT	65535	送料参数+
07:DEF AULT	65535	
08:DEF AULT	65535	

读内存文件	内存操作	U盘
-------	------	----

Figure 8.6.1-2

After selecting, press [Enter].

## 8.6.2 Array information

1. In the above interface, select the "Array Information" item and press [Enter] key, then the pop-up menu is shown in the following figure:

阵列名称:
00:DEFAULT1
01:DEFAULT2
02:DEFAULT3
03:DEFAULT4
04:DEFAULT5
05:DEFAULT6
06:DEFAULT7
07:DEFAULT8

请按<ENT>键设置参数.

Figure 8.6.2-1

2. Then in the above interface, press ▲ ▼ keys to select the item, press [Enter] key, the pop-up menu will be shown as below:

	X:	Y:	
大小	202.3	418.0	mm
个数	<u>2</u>	2	
间隔1	3	2	mm
间隔2	3	2	mm
错位	2	2	mm
镜像	<input checked="" type="checkbox"/> H <input type="checkbox"/> V	<input checked="" type="checkbox"/> H <input type="checkbox"/> V	
	<input type="button" value="读参数"/> <input type="button" value="写参数"/>		

修改请按<确定>键.

Figure 8.7.2-2

3. Press the arrow keys to select [Read Parameters], and press the [Enter] .
4. Press the arrow keys to move the red box, press [Enter] to confirm the setting of the parameters of the current red box, press the key ▲ to increase the value of the underline, and press the key ▼ to reduce the value of the underline.
5. After modification, press [Enter] to save the current parameter settings.
6. Press 【ESC】 key to cancel the modified parameter and return to the previous interface.



7. After the parameters are set, select [Write Parameters], and press [Enter] to save the parameter settings.

### 8.6.3 Feeding parameters

In the above interface, select the "Feeding Parameters" item and press [Enter] key, then the pop-up menu is shown as below:

Figure 8.6.3

1. Press the arrow keys to select [Read Parameters], and press the [Enter].
2. Press the arrow keys to move the red box, press [Enter] to confirm the setting of the current red box parameters, press the key ▲ to increase the value of the underline, and press the key ▼ to reduce the value of the underline.
3. After the modification is completed, press [Enter] to save the current parameter settings.
4. After the parameters are set, select [Write Parameters], and press [Enter] to save the parameter settings.

### 8.6.4 Memory operation

Select the "Memery oper" item in the interface above, and the pop-up menu is as shown below:

Figure 8.6.4

- Current work time: Preview the processing time of the currently selected file.
- Clear all files: Clear the number of processed files in flash memory.
- Del all memory files: delete all memory files.
- Format memory: Format the flash memory.
- Total Pieces: display the total number of processed pieces of all memory files, which can be cleared by the "clear" item on the right.

The operation method is the same as above, press [ESC] key to return to the previous menu.

## 8.6.5 Format memory

In the above interface, select the "Format Memory" item and press [Enter], the pop-up menu is shown as follows:

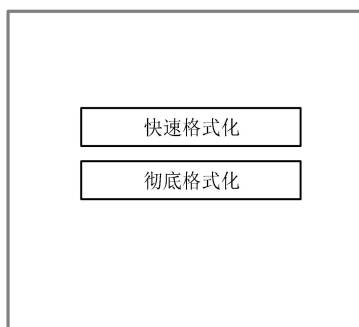

Figure 8.6.4.1

After formatting the memory, all memory files will be cleared.

The operation method is the same as above, press [ESC] key to return to the previous menu.

## 8.6.6 U disk file

Select the "Udisk" entry on the "File" interface and press [ENT] to pop up the U disk file list, as shown in the figure:

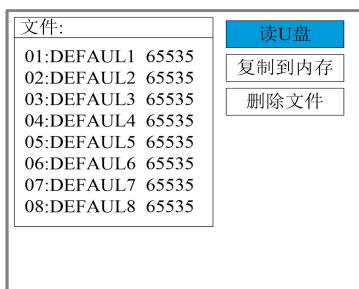



Figure 8.6.5

The operation method is the same as the memory file, press [ESC] key to return to the "File" interface.

- Read U disk file: read the U disk file list.
- Copy to memory: copy the selected file to internal memory.
- Delete file: delete the selected file in the U disk.

 <b>Prompt</b>	<p>This system supports the FAT32 and FAT16 file formats of the U disk. The file must be placed in the root directory of the U disk to be recognized by the system. File names longer than 8 characters will be automatically cut off by the system. Except for English and numbers named files. Others will not be displayed on the controller. Files copied from the controller to the U disk are placed in the root directory of the U disk.</p>
--	---

## 8.7 Password input and setting

### 8.7.1 Password input



图 8.7.1

User can select a number or letter by pressing the arrow keys, and press the [Enter] key to select, and press the [Enter] key when you enter a full six-digit password. If the password is correct, enter the next interface or perform an operation, otherwise it will display "Password" Error", re-enter.

Press **【ESC】** key to return to the previous menu.

## 8.8 Prompt and alarm information

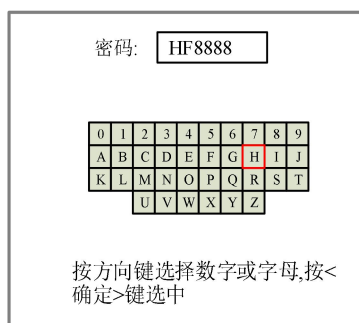
During user operation or system operation, some prompts and alarm messages will pop up, such as resetting, water protection failure, limit protection, border crossing, etc.

- Prompts

The system pops up and the system is resetting, the interface is as follows:



Figure 8.8-1

Operate according to the interface prompts.

- Alarm information

The system pops up a water protection failure, the interface is as follows:



Figure 8.8-2

Press [Enter] or [ESC], and the system will execute related operations.

## 8.9 Parameter setting operation

This chapter introduces some parameter modification operation methods when using the product.

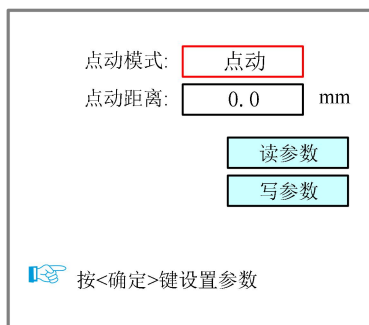



Figure 8.9.1

### 8.9.1 Option parameter box

1. When modifying a parameter box with options, first select the parameter .
2. Then press [Enter], up and down from the parameter box  , the selected parameter box changes from black to red.
3. Users only need to press the "up and down" keys to select other options, and press the [Enter] to confirm the currently selected parameter.

4. After setting all the parameters, select [write parameters] and press [Enter]

## 8.9.2 Number parameter

When user modify the numerical parameters, select the parameter box and press the [OK] key, the cursor appears below the first digit (  ), At this time, press the "up and down" key to modify the number at the cursor position (  ), For other digits, press the left and right keys to move the cursor to the digit to be modified and repeat the operation described above .

If the number of digits required for the parameter setting is greater than the current display digits, the highest display here is up to ten digits. When you need to set hundreds or more parameters, just move the cursor to the leftmost side and continue to press the "left direction" key or the rightmost to press the "right direction" key on the side, other operations are the same as above. At the same time, if the current number of display digits is greater than the number of digits required for the parameter, if the highest digit of the current display is thousands , and the parameter only needs to set the highest digit as the hundredth, and then set the number of digits before the hundredth to 0 .

When user need to set other digits, use the "up and down arrow keys" to select the parameter to be modified and perform.

Note: The parameter box has a limit on the number of digits. When the parameter digit was limited, pressing the left and right arrow keys will not increase the number.

## 8.9.3 Setting parameters from the panel

### Arrow keys

 can use to select the parameter box, the right black of the selected parameter box becomes red. Select a parameter box and press [Enter] to confirm and edit this parameter box.

If this parameter box is a selected type of parameter box, use the up and down direction keys  to select the required parameter, and then press the [Enter] key to confirm and save the parameter value modified by the current parameter box.

If this parameter box is a number type parameter box, use the left and right direction keys  to move the underline of the number, and then use the up and down direction keys to adjust the size of the number (adjust the size of the underlined number), and repeat the above steps to set the value. Finally, press [Enter] key to confirm and save the parameter value modified in the current parameter box.

 : Select the parameter box, select the options in the parameter box, and adjust the size of

the underlined value.

 : Select the parameter box and move the number underline

**【ESC】** Cancel, return to the previous level

[Enter] Confirm, save, and enter the next level

Thank you for your selection of our production!

All the copyright of this manual is owned by Ruida technology. Any person or company can not copy upload and send the manual without Ruida's permission.

Content will be revised or modified. We will not send message to every users.

If there are any question or suggestion about our products and manuals, please tells us.

Tel: (086)0755-26066687

Fax: (086)0755-26982287

Adress : 202-203,B-Block,Technology Building,NO.,1057 Nanhai Avenue,Nanshan district,  
Shenzhen, Guangdong , China.

Website: [www.rd-ac.com](http://www.rd-ac.com)