

SYNTEC

Mill Machine Program Manual

By: SYNTEC

Date: 2015/05/11

Version: 8.19

版本更新記錄

項次	更改內容紀錄	更改日期	作者	更改後版本
01	初版定稿	2001/07/01		V8.6
02	修正 G87 規格說明	2006/04/21	賴春億	V8.7
03	修正 G84 規格說明	2006/05/09	林昀暉	V8.8
04	修正 G73~G89 Z,R 引數規格說明	2006/05/25	賴春億	V8.9
05	修正 G65 G66 G67 規格說明	2006/07/18	賴春億	V8.10
06	修正 G50 G51 範例 修正 Page59 說明----重覆次數引數 L 為 K	2006/10/12	賴春億	V8.11
07	新增 G05, G06.2 規格說明	2008/11/17	王芝峰	V8.12
08	修改圖片 並與中文手冊同步	2010/4/20	陳弘真	V8.13
09	與中文手冊同步	2012/01/02	謝鎮陽	V8.14
10	G05.1 說明圖片中文化	2012/08/02	楊念祖	V8.15
11	修正 G01 規格說明	2013/11/26	吳長壽	V8.16
12	增加 G05 的注意事項	2015/03/31	許哲榮	V8.17
13	加入 G37 和 G37.1 說明	2015/04/07	謝汶宏	V8.18
14	修改 G37 和 G37.1 說明	2015/05/11	許哲榮	V8.19

Contents

1	G Function Description.....	1
1.1	G code list	1
1.2	G code description	3
1.2.1	G00: POSITIONING	3
1.2.2	G01: LINEAR INTERPOLATION	4
1.2.3	G02/G03: CIRCULAR INTERPOLATION.....	7
1.2.4	G02/G03: HELICAL INTERPOLATION.....	11
1.2.5	G04: Dwell.....	13
1.2.6	G05: High Speed & High Precision Interpolation	14
1.2.7	G05.1 Path Smoothing	16
1.2.8	G06.2 NURBS Curve Interpolation	19
1.2.9	G09/G61: EXACT STOP	22
1.2.10	G10: PROGRAMMABLE DATA INPUT	23
1.2.11	G15/G16 POLAR COORDINATES COMMAND MODE	25
1.2.12	G17/G18/G19: PLANE SELECTION	29
1.2.13	G28: RETURN TO REFERENCE POSITION	30
1.2.14	G29: RETURN FROM REFERENCE POSITION	31
1.2.15	G30: 2 nd , 3 rd and 4 th REFERENCE POSITION RETURN.....	33
1.2.16	G31: SKIP FUNCTION.....	35
1.2.17	G33: THREAD INTERPOLATION.....	38
1.2.18	G37: AUTOMATIC TOOL LENGTH MEASUREMENT - I....	40
1.2.19	G37.1: AUTOMATIC TOOL LENGTH MEASUREMENT - II	43
1.2.20	G40/G41/G42: CUTTER COMPENSATION.....	46
1.2.21	G43/G44/G49: TOOL LENGTH COMPENSATION.....	53
1.2.22	G51/G50: SCALING	56
1.2.23	G51.1/G50.1: PROGRAMMABLE MIRROR IMAGE	58
1.2.24	G52: LOCAL COORDINATE SYSTEM	64
1.2.25	G53: MACHINE COORDINATE SYSTEM SELECTION.....	67
1.2.26	G54...G59.9: WORKPIECE COORDINATE SELECTION.....	69
1.2.27	G64: CUTTING MODE	72
1.2.28	G65: SIMPLE CALL	74
1.2.29	G66/G67: MACRO CALL	75
1.2.30	G68/G69: COORDINATE ROTATION	76
1.2.31	G70/G71: UNIT SETTING OF INCH/METRIC SYSTEM	80
1.2.32	Cycle perform function:	81
1.2.33	G73: HIGH SPEED PECK DRILL CYCLE	84

1.2.34	G74: LEFT HAND TAPPING CYCLE	87
1.2.35	G76: FINE BORING CYCLE	91
1.2.36	G81: DRILLING CYCLE.....	96
1.2.37	G82: DRILLING CYCLE OF DWELL ON THE HOLE BOTTOM.....	98
1.2.38	G83: PECK DRILL CYCLE	101
1.2.39	G84: TAPPING DRILLING CYCLE.....	104
1.2.40	G85: DRILLING CYCLE.....	110
1.2.41	G86: HIGH SPEED DRILLING CYCLE	113
1.2.42	G87: FINE BORING CYCLE OF BACK SIDE	116
1.2.43	G88: FINE BORING CYCLE OF HALF AUTOMATION.....	121
1.2.44	G89: BORING CYCLE OF DWELL ON THE HOLE BOTTOM 124	
1.2.45	G90/G91: ABSOLUTE/INCREMENT COMMEND	127
1.2.46	G92: SETTING OF WORK COORDINATE SYSTEM.....	128
1.2.47	G94/G95: FEED UNIT SETTING	129
1.2.48	G96/G97: CONSTANT LINEAR VELOCITY CONTROL ON SURFACE.....	130
1.2.49	G134: CIRCUMFERENCE HOLE CYCLE	132
1.2.50	G135: ANGULAR STRAIGHT HOLE CYCLE	134
1.2.51	G136: ARC TYPE HOLE CYCLE.....	135
1.2.52	G137.1: CHESS TYPE HOLE CYCLE	136
1.2.53	Tool Function: T Code Command	138
1.2.54	Spindle Speed Function: S Code Command.....	138
1.2.55	Cyclic Processing Function.....	138

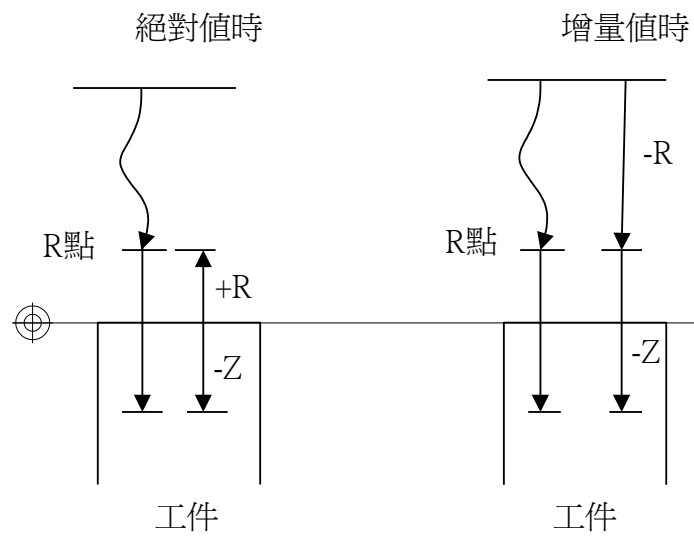

..... 141

1.2.56 Feed Function: F Code Command 141

2 M Code Description: 142

1 G Function Description

1.1 G code list

G code	Function	PS.	Item	Function name	PS.
G00	Positioning		G64	Cutting mode	
G01	Linear interpolation		G65	Marco call	※
G02	Circular interpolation /Helical interpolation (CW)		G66	Marco modal call	※
G03	Circular interpolation /Helical interpolation (CCW)		G67	Marco modal call cancel	※
G04	Dwell ,exact stop		G68	Coordinate rotation	
G05	High speed and high precision interpolation		G69	Coordinate rotation cancel	
G09	Exact stop		G70	Inch perform	
G10	Programmable data input		G71	Mm perform	
G15	Polar coordinates command cancel		G73	Peck drilling cycle	
G16	Polar coordinates command		G74	Counter tapping cycle	
G17	X-Y plane selection		G76	Fine boring cycle	
G18	Z-X plane selection		G80	Canned cycle cancel	
G19	Y-Z plane selection		G81	Drilling cycle	
G28	Return to reference position		G82	Drilling cycle of dwell on the hole bottom	
G29	Return from reference position		G83	Peck drilling cycle	
G30	2 nd ,3 rd and 4 th reference position return		G84	Tapping cycle	
G31	Skip function		G85	Drilling cycle	
G33	Thread cutting		G86	High speed drilling cycle	
G40	Cutter compensation		G87	Fine boring cycle of back	

	cancel			side	
G41	Cutter compensation left		G88	Fine boring cycle of half automation	
G42	Cutter compensation right		G89	Boring cycle of dwell on the hole bottom	
G43	Tool length compensation + direction		G90	Absolute command	
G44	Tool length compensation - direction		G91	Increment command	
G49	Tool length compensation cancel		G92	Setting of work coordinate system	
G50	Scaling		G94	Feed per minute(mm/min.)	
G51	Scaling cancel		G95	Feed per rotation (mm/rev.)	
G50.1	Programmable mirror image cancel		G96	Constant linear velocity control on surface	
G51.1	Programmable mirror image		G97	Constant linear velocity control on surface cancel	
G52	Local coordinate system setting		G98	Return to initial point in canned cycle	
G53	Machine coordinate system setting		G99	Return to R point in canned cycle	
G54	Workpiece coordinate system 1 selection		G134	Circumference hole cycle	
G59	Workpiece coordinate system 6 selection		G135	Angular straight hole cycle	
G61	Exact stop mode		G136	Arc type hole cycle	
			G137.1	Chess type hole cycle	

- SYNTEC 900M G code uses RS274D standards, and the only differences with FANUC 0M are G70, G71 respective to G20, G21.

1.2 G code description

1.2.1 G00: POSITIONING

Command form:

G00 X__Y__Z__ ;

X、Y、Z: Specified point

Description:

each axes move to appointed point in no interpolation status, X、Y、Z is the final position, use G90/G91 to design absolute or increment value.

<Notice>: the movement mode can decide by parameter #411
(0: linear, 1: each axle move in max speed independently)

PIC:

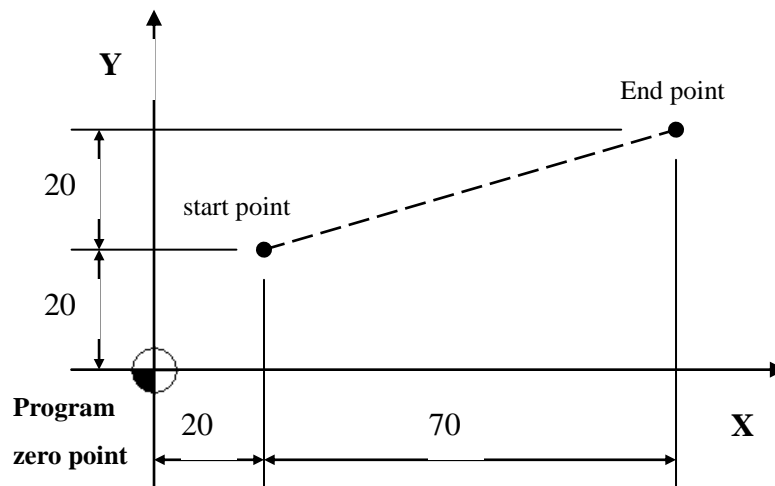

Program description:

1. first way(absolute): G90 G00 X90.0 Y40.0 ;

//use difference value between appointed point and zero point to do straight interpolation to appointed point

2. second way(increment): G91 G00 X70.0 Y20.0 ;

// use difference value between appointed point and initial point to do straight interpolation to appointed point

1.2.2 G01: LINEAR INTERPOLATION

Command form:

G01 X__Y__Z__ F__ ;

X、Y、Z: Specified point

F: Feed rate, Unit: mm/rev (inch/rev) for G95

mm/min (inch/min) for G94 ← default mode

Description:

G01 executes linear interpolation, it can be used G90/G91 to decide absolute or increment mode, use feed rate provided by F to go to the specified position.

Note:

- The max. feed rate of G01 is defined by PR405-maximum cutting feed rate or (PR621~PR636)-each axis maximum cutting feed rate
- Default value F: 1000mm/min(inch/min) for G94 mode and 1.mm/rev(inch/rev) for G95 mode
- Default mode G94/G95 can be changed by parameter Pr3836 (reboot controller to activate setting).

Example 1:

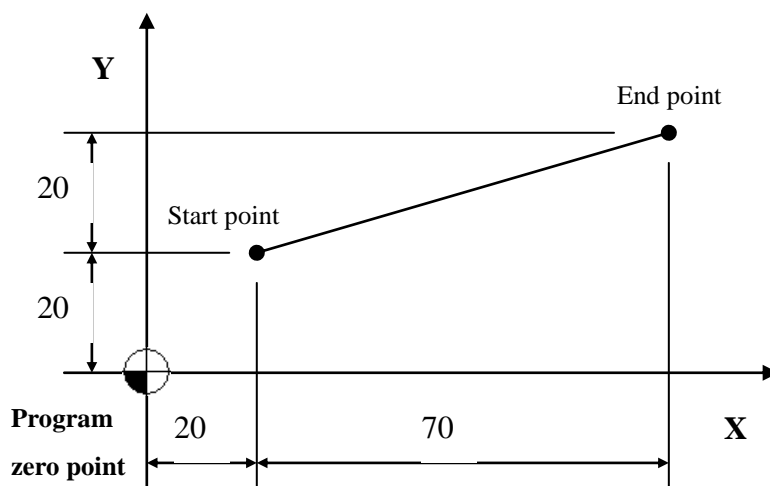

1. absolute command: G90 G01 X90.0 Y40.0 ;

//do linear interpolation from zero point to the specified point(90,40)

2. increment command: G91 G01 X70.0 Y20.0 ;
// the tool does linear interpolation X + 70 and Y + 20 to specified point

Example 2: processing example

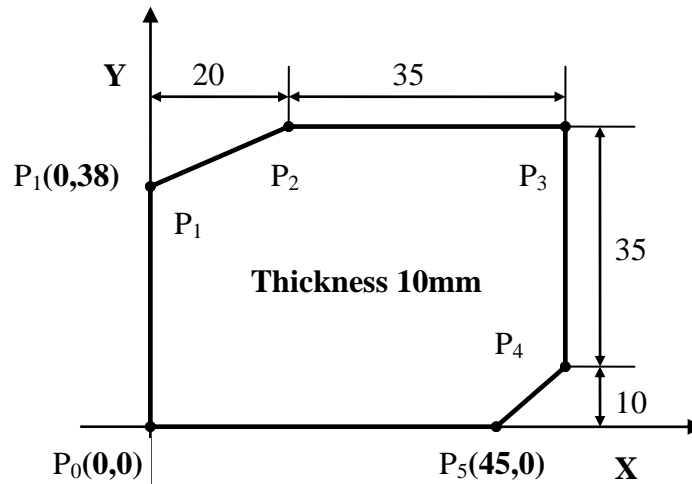

Program description:

1. absolute way:

```

N001 G00 X0.0 Y0.0 Z10.0 ; //positioning to above of P0
N002 G90 G01 Z-10.0 F1000 ; //straight interpolation to bottom of
workpiece, speed 1000mm/min
N003 Y38.0 ; //P0 → P1
N004 X20.0 Y45.0 ; //P1 → P2
N005 X55.0 ; //P2 → P3
N006 Y10.0 ; //P3 → P4
N007 X45.0 Y0.0 ; //P4 → P5
N008 X0.0 ; //P5 → P0
N009 G00 Z10.0 ; //positioning back to above of P0
N010 M30 ; //program end

```

2. increment way

```

N001 G00 X0.0 Y0.0 Z10.0 ; //positioning to above of P0
N002 G91 G01 Z-20.0 F1000 ; //straight interpolation to bottom of
workpiece, speed 1000mm/min
N003 Y38.0 ; //P0 → P1
N004 X20.0 Y7.0 ; //P1 → P2
N005 X35.0 ; //P2 → P3
N006 Y-35.0 ; //P3 → P4
N007 X-10.0 Y-10.0 ; //P4 → P5
N008 X-45.0 ; //P5 → P0
N009 G00 Z20.0 ; //positioning back to above of P0
N011 M30 ; //program end

```

1.2.3 G02/G03: CIRCULAR INTERPOLATION

Command form:

1. X-Y plane circular interpolation:

$$G17 \left\{ \begin{array}{l} G02 \\ G03 \end{array} \right\} X_ Y_ \left\{ \begin{array}{l} R_ \\ I_ J_ \end{array} \right\} F_;$$

2. Z-X plane circular interpolation:

$$G18 \left\{ \begin{array}{l} G02 \\ G03 \end{array} \right\} X_ Z_ \left\{ \begin{array}{l} R_ \\ I_ K_ \end{array} \right\} F_;$$

3. Z-X plane circular interpolation

$$G19 \left\{ \begin{array}{l} G02 \\ G03 \end{array} \right\} Y_ Z_ \left\{ \begin{array}{l} R_ \\ J_ K_ \end{array} \right\} F_;$$

X, Y, Z: Specified point

I, J, K: the vector value that starting point of arc to the center of a circle(center of a circle – starting point)

R: Radius of arc

F: Feed rate

G90/G91 decide absolute or increment

Description:

G02、G03 do circular interpolation according to appointed plane、coordinate system、size of arc and speed of interpolation, and the rotate direction decide by G02(CW)、G03(CCW). Description of the command format as below:

	Setting Data	Command	Definition
1	Plane selection	G17	X-Y plane setting
		G18	X-Z plane setting
		G19	Y-Z plane setting
2	Direction	G02	Clockwise direction (CW)
		G03	Counterclockwise direction (CCW)

3	End position	G90	Two axes of X, Y, Z	End coordinate of arc
		G91	Two axes of X, Y, Z	Vector value from start point to end point
4	Distance from start point to center of circle		Two axes of I, J, K	Vector value from start of arc to center of circle
	Radius of arc		R	Radius of arc
5	Speed of feed (feedrate)		F	Feedrate along the arc

Example:

1. G02, G03 direction

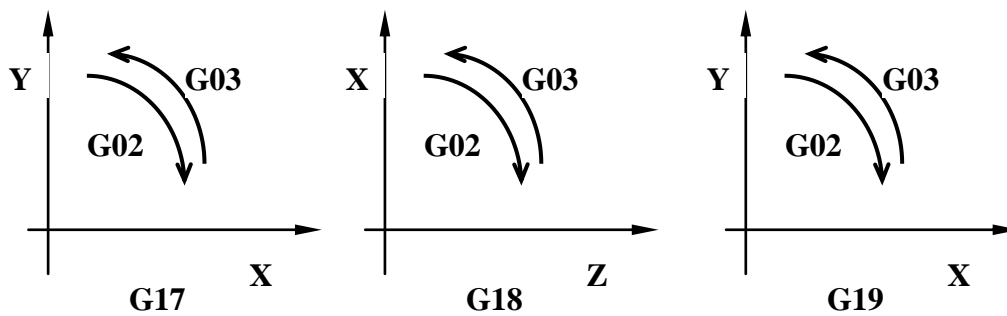

2. I, J, K definition:

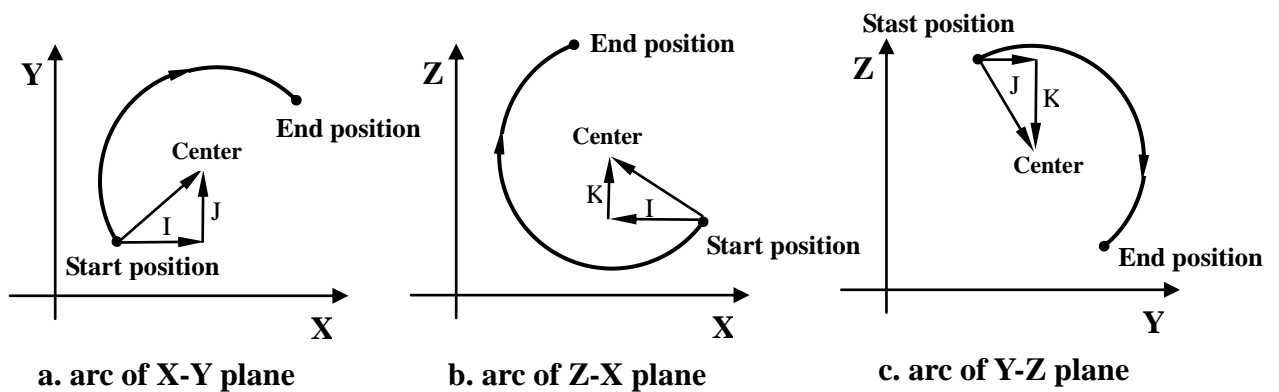

3. how to use R:

- ◆ When $\theta \leq 180$ degree, R is positive.

$$\begin{Bmatrix} G02 \\ G03 \end{Bmatrix} X_ Y_ R25.0;$$

- ◆ When $180 \text{ degree} < \theta < 360$ degree, R is negative.

$$\begin{Bmatrix} G02 \\ G03 \end{Bmatrix} X_ Y_ R-25.0;$$

- ◆ When $\theta = 360$ degree, only use **I**、**J**、**K**.

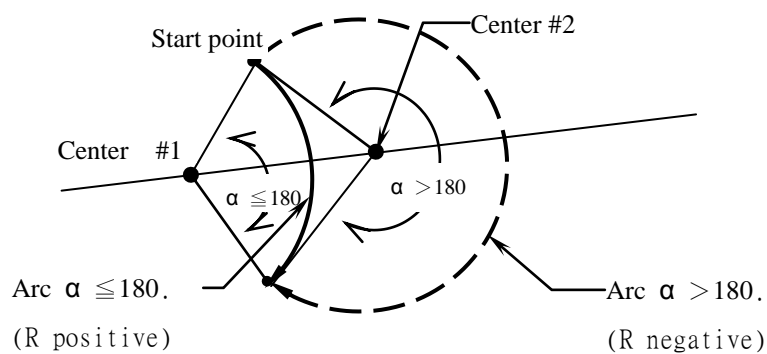

Program example 1:

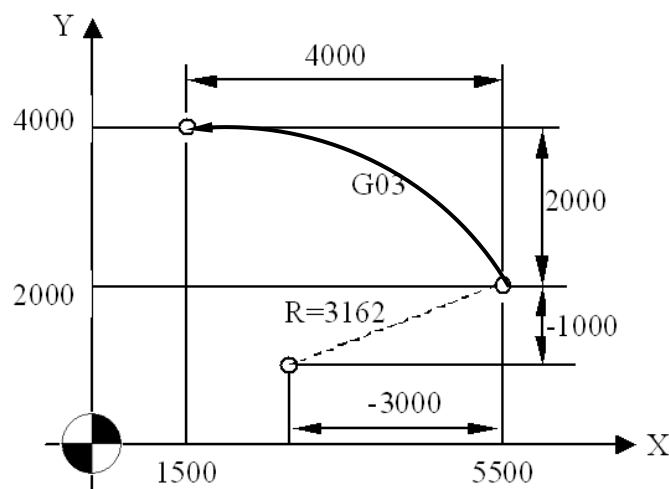

```
G90 G00 X5500 Y4000;//positioning to start point of arc
G17 G90 G03 X1500 Y4000 I-3000 J-1000 F200;
//absolute command
(G17 G91 G03 X-4000 Y2000 I-3000 J-1000 F200;
//increment command)
```

Program example 2: (interpolate a full circle)

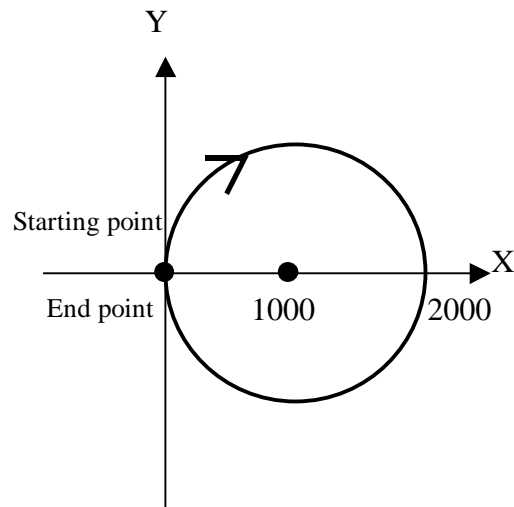

```
G90 G00 X0 Y0;  
G02 I1000 F100; //interpolate a full circle
```

1.2.4 G02/G03: HELICAL INTERPOLATION

Command form:

(1)

$$G17 \left\{ \begin{array}{l} G02 \\ G03 \end{array} \right\} X_ Y_ \left\{ \begin{array}{l} R_ \\ I_ J_ \end{array} \right\} Z_ F_;$$

X, Y: end position of arc ;

Z: end position of straight line ;

R: radius of arc ;

I, J: center position of arc ;

F: speed of tool feed(feed rate) ;

(2)

$$G18 \left\{ \begin{array}{l} G02 \\ G03 \end{array} \right\} X_ Z_ \left\{ \begin{array}{l} R_ \\ I_ K_ \end{array} \right\} Y_ F_;$$

X, Z: end position of arc ;

Y: end position of straight line ;

R: radius of arc ;

I, K: center position of arc ;

F: speed of tool feed(feed rate) ;

(3)

$$G19 \left\{ \begin{array}{l} G02 \\ G03 \end{array} \right\} Y_ Z_ \left\{ \begin{array}{l} R_ \\ J_ K_ \end{array} \right\} X_ F_;$$

Y, Z: end position of arc ;

X: end position of straight line ;

R: radius of arc ;

J, K: center position of arc ;

F: speed of tool feed(feed rate) ;

Description:

When the 3rd axis which is vertical to arc plane moves, G02/G03 is to be helical interpolation. The choice of helical interpolation is the same as circular interpolation. Helical interpolation uses G code(G17/G18/G19) to decide which plane to do circular interpolation.

G17 form: synchronously with arc of X-Y plane.

G18 form: synchronously with arc of Z-X plane.

G19 form: synchronously with arc of Y-Z plane

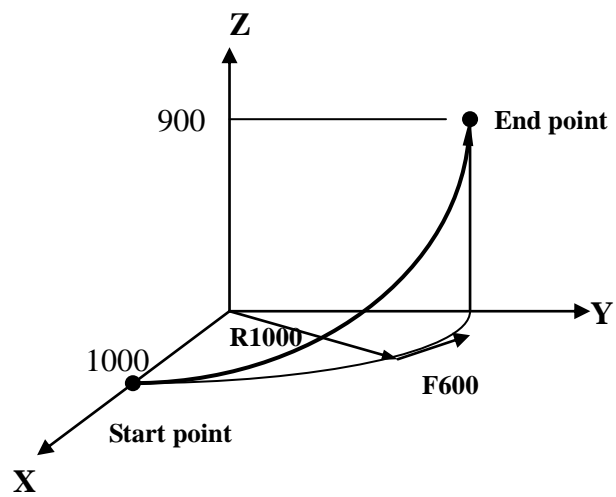

Program description:

```
G17 G03 X0.0 Y1000.0 R1000.0 Z900.0 F600 ;
```

// synchronously with arc of X-Y plane (CCW), do helical interpolation
with feedrate 600mm/min

1.2.5 G04: Dwell

Command form:

$$G04 \left\{ \begin{array}{l} X_ \\ P_ \end{array} \right\} ;$$

X: specific time (decimal point permitted 0.001~9999.999s)

P: specific time (decimal point not permitted)

Description:

By specifying a dwell, the execution of the next block is delayed by the specified time. In addition, a dwell can be specified to make an exact check in the cutting mode.

Program example:

G04 X2500;//delay 2.5 sec

G04 X2.5;//delay 2.5 sec

G04 P2500;//delay 2.5 sec

G04 P2.5;//delay 2 sec (decimal point not permitted)

1.2.6 G05: High Speed & High Precision

Interpolation

Command form:

$$G05 \ P \left\{ \begin{array}{c} 10000 \\ 1 \\ 2 \\ 3 \\ 4 \\ 5 \end{array} \right\} ; \ // \text{Start HSHP interpolation}$$

G01 X__Y__Z__F__;

G02 X__Y__Z__R__;

G00 X__Y__Z__;

G05 P0; // Cancel HSHP interpolation

P: Multiple motion parameters

X, Y, Z: Specific coordinate point

F: Max feedrate (mm/min)

Description:

G05 provides one default parameter, P10000, and five other parameters, P1~P5, for users. Interpolation commands execute the mode of smoothing curve by processing program. G90/G91 decides absolute or increment mode. Feedrate is decided by **F** code for high speed & high precision interpolation.

Condition:

- On high speed & high precision interpolation (G05 P__) mode, M code and MPG simulation of negative direction are invalid.
- On high speed & high precision interpolation (G05 P__) mode, if cutter compensation(G40/G41/G42) and tool length compensation (G43/G44/G49) are used, the program can cancel G05 mode until G40/G41/G42 or G43/G44/G49 ending. It is not recommended to do that unless necessary.

- On high speed & high precision interpolation (G05 P__) mode, M30 or M99 is needed to be added in the end of program.

Example:

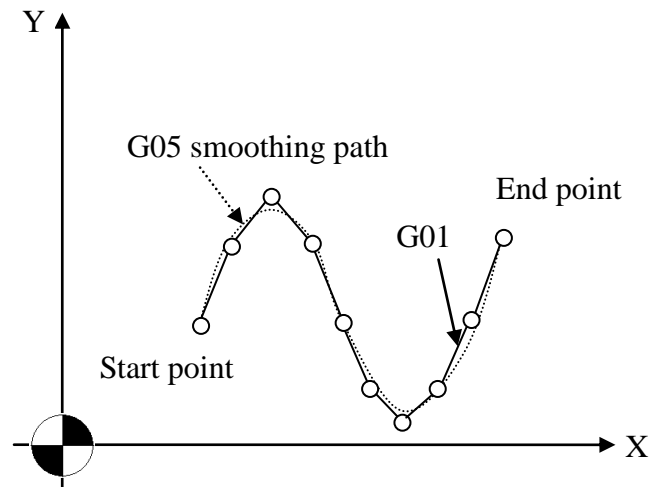

```
G0 X3. Y4. Z0.
G05 P10000 //Start high speed & high precision interpolation
G01 X3.8 Y6.1 F5000.
X4.6 Y7.
X5.4 Y6.1
X6.1 Y4.
X6.9 Y1.9
X7.7 Y1.
X8.5 Y1.9
X9.3 Y4.
X10. Y6.1
G05 P0 // Cancel high speed & high precision interpolation
M30
```

1.2.7 G05.1 Path Smoothing

Command form :

G5.1 Q1 E_ : Start path smoothing function

:

G5.1 Q0 : Close path smoothing function

Q : Switch to start/Close the smoothing function

E : The maximum allowable path error while smoothing. Use “mm” as the unit.

Descriptions

1. If command is inadequate (ex: Q or E unspecified), it will be ineffective.
2. G90 and G91 can both be used in conjunction with G05.1.
3. Path smoothing is only effective on command G01 between G5.1 Q1 E and G5.1 Q0.
4. Under G5.1 mode, press single block stop will not necessarily stop the process at the end of the block.

Conditions:

1. Under G61/G63 mode, Commands to start path smoothing (G5.1) are prohibited. Otherwise, system will issue the alarm.
2. Under G5.1 mode, if G61/G63 is performed, path smoothing will stop. Until system leaves G61/G63 mode, path smoothing function will be restart automatically.
3. Under G5.1, If command G01 is after tool length compensation command(G43) or coordinate transformation command(G54), path smoothing will not be performed. Afterwards, G01 command returns to perform path smoothing.

Figure

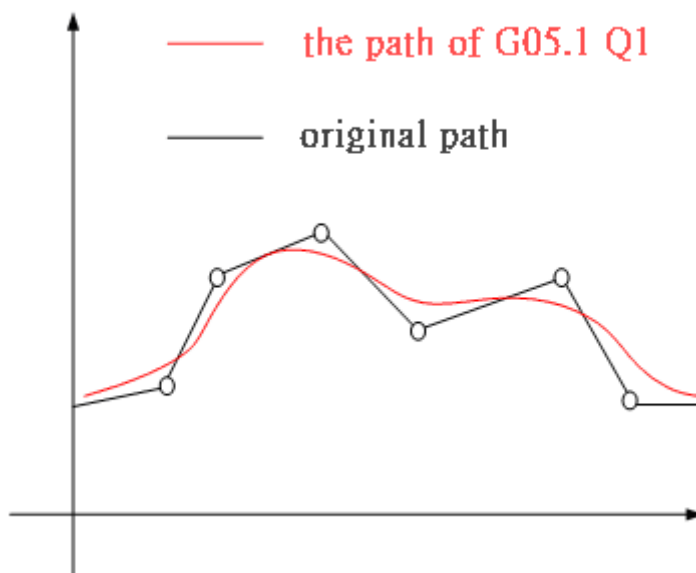

Example 1

```
N001 G05.1 Q1 E0.01 //Start path smoothing function, allowable error:
10um
N002 G90 G01 F2000
```

```
N003 X-0.002 Y-0.001 //the following commands perform path smoothing
function
N004 X-0.003 Y-0.003
N005 X-0.004 Y-0.005
N006 X-0.005 Y-0.007
N007 X-0.007 Y-0.008
N008 X-0.008 Y-0.009
N009 X-0.011 Y-0.010
N010 X-0.013 Y-0.012
N011 X-0.014 Y-0.013
N012 X-0.015 Y-0.015
N013 X-0.016 Y-0.018
N014 G05.1 Q0 // close path smoothing function
N015 M30 //program ends
```

Example 2

```
N001 G05.1 Q1 E0.01 //Start path smoothing function, allowable error:
10um
N002 G91 G01 F2000
N003 X-0.002 Y-0.001 //the following commands perform path smoothing
function
N004 X-0.001 Y-0.002
N005 X-0.001 Y-0.002
N006 X-0.001 Y-0.002
N007 X-0.002 Y-0.001
N008 X-0.001 Y-0.001
N009 X-0.003 Y-0.001
N010 X-0.002 Y-0.002
N011 X-0.001 Y-0.001
N012 X-0.001 Y-0.002
N013 X-0.001 Y-0.003
N014 G05.1 Q0 // close path smoothing function
N015 M30 //program ends
```

Example 3

```
G5.1 Q1 E0.1 // Start path smoothing function, allowable error: 100um
G91 G01 F2000 // the following commands perform path smoothing function
X -0.005
:
G43 H3 //G43command
Y -0.005 // this command doesn't perform path smoothing function
X -0.005 // restart path smoothing function
:
M30 //program ends
```

Example 4

```
G5.1 Q1 E0.05 // Start path smoothing function, allowable error: 50um
G90 G01 F2000 // the following commands perform path smoothing
function
X-0.005 Y0.
:
X-0.1Y-0.01
G61 //start G61 mode and close path smoothing function
X-0.1Y-0.02 //the following commands do not perform path
smoothing function
:
X0.005 Y0.
G64 //close G61
X0.005 Y0.01 //restart path smoothing function
:
M30 //program ends
```

1.2.8 G06.2 NURBS Curve Interpolation

Command form

```
G05 P10000;// Start high speed & high precision interpolation
:
G06.2 P_K_X_Y_Z_R_F_;//NURBS curve interpolation
K_X_Y_Z_R_;
K_X_Y_Z_R_;
K_X_Y_Z_R_;
K_;
```

K__;

K__;

K__;

:

G05 P0;// Cancel high speed & high precision interpolation

P : Order of NURBS curve (2 ~ 4), default value is 4 if it is leaved blank.

K : NURBS node value of curve

X 、 Y 、 Z : NURBS control-point coordinates

R : NURBS curve weight (0.001 ~ 1000), default value is 1.0 if it is leaved blank.

F : The maximum feedrate of NURBS curve (mm/min) · default value is that of previous curve if it is leaved blank.

Description:

G06.2 cutting command executes NURBS curve interpolation according to the program. G90/G91 determines whether absolute or incremental mode is used. The cutting feedrate of NURBS curve interpolation is set by “F” function.

Condition

Single block Execution and hand-wheel simulation in negative direction are not supported.

Definition of NURBS curve :

A NURBS curve can be expressed as the formula shown below :

p : Order of NURBS curve rank

$$U = \left\{ \underbrace{a, \dots, a}_{p+1}, u_{p+1}, \dots, u_{n-p-1}, \underbrace{b, \dots, b}_{p+1} \right\} : \text{node vector of NURBS curve}$$

$$u_i \leq u_{i+1}, m = n + p + 1$$

P_i : coordinates of NURBS curve control point

w_i : weight of NURBS curve

The definition of NURBS basis function is :

$$N_{i,p}(u) = \begin{cases} 1, & u_i \leq u < u_{i+1} \\ 0, & \text{otherwise} \end{cases}$$

$$N_{i,p}(u) = \frac{u - u_i}{u_{i+p} - u_i} N_{i,p-1}(u) + \frac{u_{i+p+1} - u}{u_{i+p+1} - u_{i+1}} N_{i+1,p-1}(u).$$

Example:

```
N001 G0 X0.0 Y0.0 Z0.0
N002 G05 P10000 //Start high speed & high precision
interpolation
N003 G06.2 P3 K0.0 X0.0 Y0.0 Z0.0 R1.0 F5000.
//execute NURBS curve interpolation
N004 K0.0 X0.0 Y5.0 Z0.0 R1.0
N005 K0.0 X5.0 Y5.0 Z0.0 R1.0
N006 K1.0
N007 K1.0
N008 K1.0
N009 G05 P0 // high speed & high precision interpolation off
```

1.2.9 G09/G61: EXACT STOP

Command form:

G09 X__ Y__ Z__ ;

G61 ;

X, Y, Z: position of exact stop

Description:

when cut the corner, because tool moves too fast or servo system delays, tool can not cut the exact shape of corner, but when you need to cut high precision rectangular, you can use G09 or G61 to make it, it slow down the tool when approach to corner, when reach to the specified position (in CNC parameter range), it will run the next block. G09 exact stop only effected in one block which has G09; G61 exact stop effected each cutting command (G01~G03) after G61, until G62 or G63 or G64 is specified.

Notice:

G01 check window: parameter 421-440

G00 check window: parameter 461-480

Example:

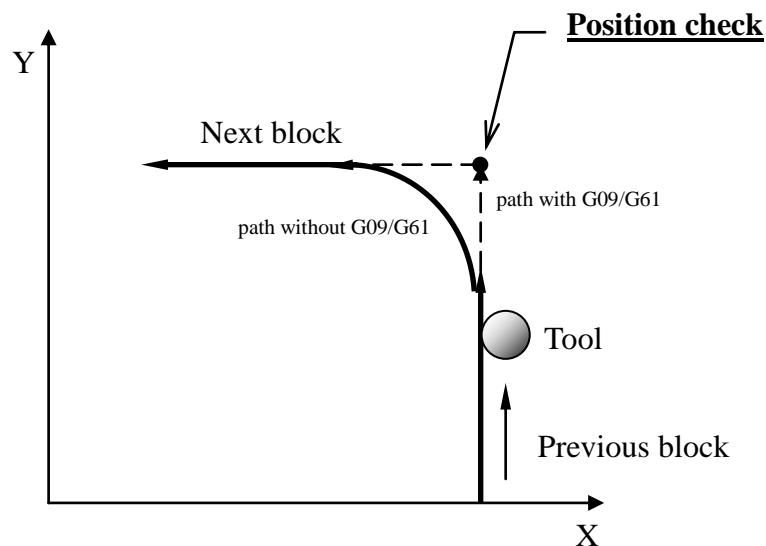

1.2.10 G10: PROGRAMMABLE DATA INPUT

Command form:

$$G10 \begin{Bmatrix} L10 \\ L11 \\ L12 \\ L13 \end{Bmatrix} P_ R_ ;$$

L10: for tool length(H) geometric compensation value

L11: for tool length(H) wear compensation value

L12: for tool diameter(D) geometric compensation value

L13: for tool diameter(D) wear compensation value

P: tool NO.

R: compensation value(data of tool length or tool diameter)

Description:

G10 command: it can directly use program command to enter tool compensation value.

In absolute mode (G90), value of G10 is the new compensation value; in increment mode (G91), value of G10 is the sum of the value of the moment with the new compensation value.

Example:

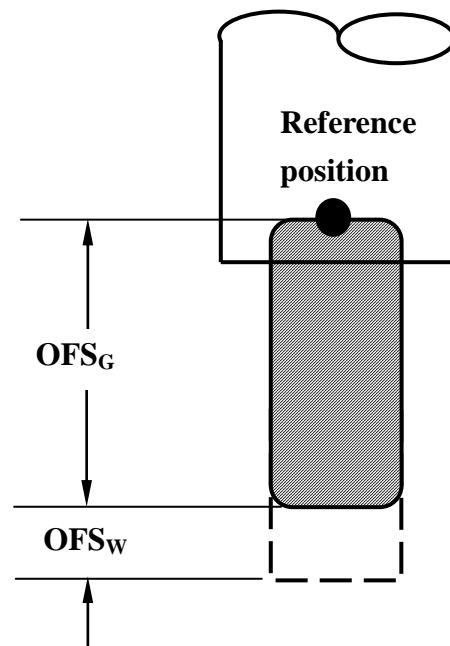

1.2.11 G15/G16 POLAR COORDINATES

COMMAND MODE

Command form:

```
G16;           //Start polar coordinate mode
G _ X _ Y _
:
:
G15;           //Cancel polar coordinate command
```

} //Polar coordinate command

X: polar coordinate radius

Y: polar coordinate angle(“+” for CW, ”-” for CCW)

Description:

start polar coordinate mode in first line, G16 for polar coordinate command start, G15 for polar coordinate command cancel, it can use polar coordinate mode to enter position(radius and angle), G90/G91 can specify in it. First address is radius, second address is angle. Absolute or increment is decided by G90 or G91, G90 is absolute, G91 is increment, in absolute mode, the increase of radius or angle from origin point; in increment mode, angle or radius total from the last radius or angle.

Example:

1. when polar coordinate zero point is the same as working coordinate

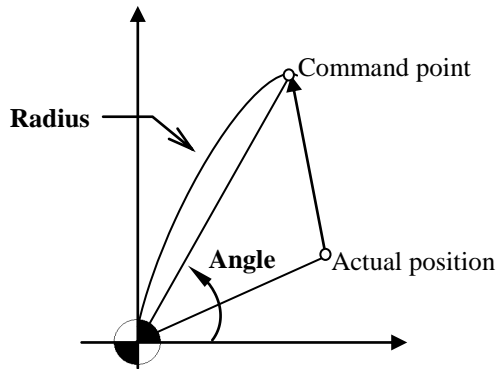

- a. When angle is specified with an absolute command

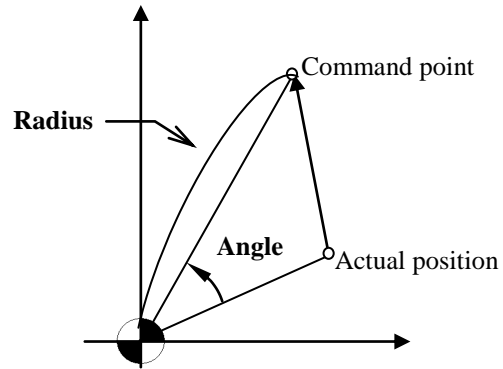

- b. when angle is specified with an increment command

2. when polar coordinate zero point is in normal position

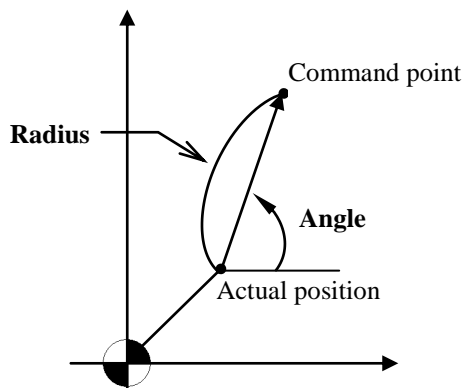

- a. When angle is specified with an absolute command

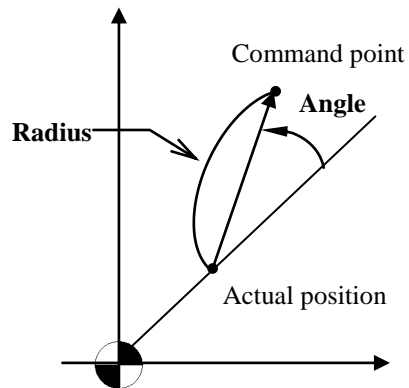

- b. when angle is specified with an increment command

Program example:

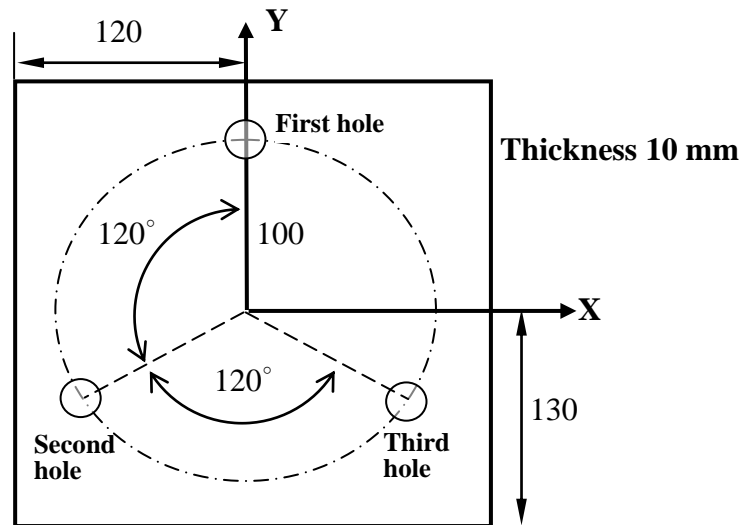

1. Absolute command:

N001 T1 S1000 M03 ;

//NO.1 tool(diameter 10 mm drill), spindle 1000rpm (CW)

N002 G17 G90 G16 ;

//X-Y plane, absolute mode, start polar coordinate mode

N003 G99 G81 Z-12.0 R2.0 F600 K0 ;

//do drilling cycle, depth 12mm, feedrate 600mm/min, back to R point when finish

N004 X100.0 Y90.0 ;

//specified a distance 100mm, angle 90 degree(first hole)

N005 Y210.0 ;

//specified a distance 100mm and angle 210 degree, from the origin point(second hole)

N006 Y330.0 ;

//specified a distance 100mm and angle 330 degree, from the origin point(third hole)

N007 G15 G80 M05 ;

//polar coordinate mode cancel, cycle cancel, spindle stop

N008 M30 ; //program end

2. Increment command:

N001 T1 S1000 M03 ;

// NO.1 tool(diameter 10 mm drill), spindle 1000rpm (CW)

```
N002 G17 G90 G16 ;  
// X-Y plane, absolute mode, start polar coordinate mode  
N003 G99 G81 Z-12.0 R2.0 F600 K0 ;  
// do drilling cycle, depth 12mm, feedrate 600mm/min, back to R point  
when finish  
N004 X100.0 Y90.0 ;  
//specified a distance 100mm, angle 90 degree(first hole)  
N005 G91 Y120.0 K2 ;  
//increment command, angle totals 120 degree from last point (second  
hole)  
N006 Y120.0 ;  
//increment command, angle totals 120 degree from last point (third  
hole)  
N007 G15 G80 M05 ;  
// polar coordinate mode cancel, cycle cancel, spindle stop  
N008 M30 ; //program ends
```

1.2.12 G17/G18/G19: PLANE SELECTION

Command form:

G17; X-Y plane selection

G18; Z-X plane selection

G19; Y-Z plane selection

Description:

when use circular interpolation, tool radius compensation or polar coordinate command, need to use G17, G18, or G19 to set cutting plane and tell controller the working plane(default G17).

Example:

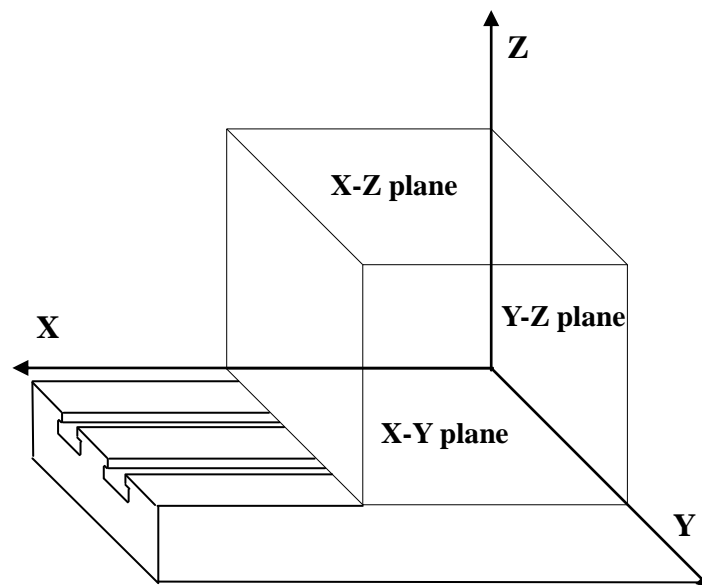
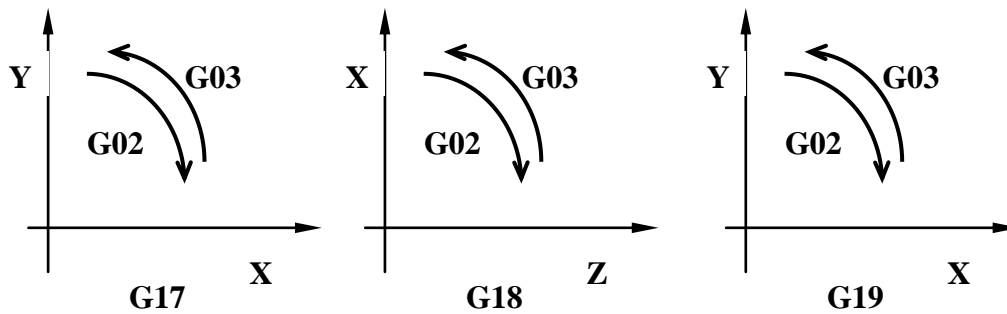

1.2.13 G28: RETURN TO REFERENCE POSITION

Command form:

G28 X__Y__Z__ ;

X, Y, Z: mid-point position (absolute value in G90 mode, increment value in G91 mode)

Description:

it can return to reference position or return to origin point, in order not to let the tool crush, it will use G00 mode to move from present position, it will move to the specified safety mid-point first and then return to origin point or reference point.

<Note> this command usually use in auto tool exchange. For safety, before doing G28, must cancel tool compensation

Example 1:

G90 G28 X50.0 Y30.0; //A→B→C, mid-point(50,30)

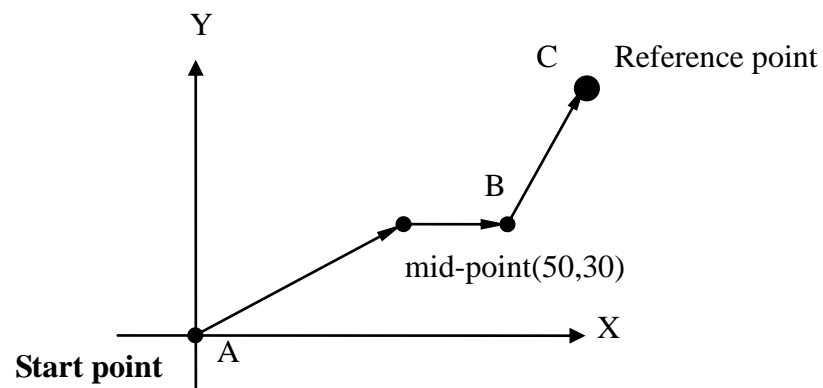

Example 2:

G28 X0; //only X axis return to reference point

G28 Y0; //only Y axis return to reference point

G28 Z0; //only Z axis return to reference point

1.2.14 G29: RETURN FROM REFERENCE

POSITION

Command form:

G29 X__Y__Z__;

X, Y, Z: specified coordinate ; (absolute value in G90 mode, increment value in G91 mode)

Description:

G29 can let tool from reference point through mid-point to specified point after setting G28. Notice that G29 can not use alone, because G29 does not specify mid-point, G29 use the mid-point from G28, therefore, before do G29 must do G28 first.

Under G90, the specified point is the absolute coordinate; under G91, it is the increment distance from mid-point to specified point.

Example:

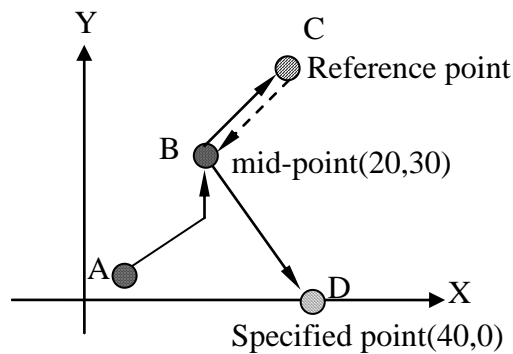

1. Absolute command:

```
N001 G90 G28 X20.0 Y30.0;
```

//A→B→C, mid-point(20,40), in absolute command mode

```
N002 M06;//change the tool
```

```
N003 G29 X40.0 Y0.0;
```

// C→B→D, the specified point is absolute coordinate

2. Increment command:

```
N001 G91 G28 X20.0 Y40.0;
```

//A→B→C, mid-point(20,40), in increment command mode
N002 M06;//change the tool
N003 **G29** X40.0 Y-40.0;
//C→B→D, the specified position is the increment value from
mid-point to specified point

1.2.15 G30: 2nd, 3rd and 4th REFERENCE POSTION

RETURN

Command form:

G30 Pn X__ Y__ Z__ ;

X、Y、Z: mid-point coordinates ; (absolute value under G90, increment value under G91)

Pn: Specified reference point(parameter #2801 ~ #2860)

P1: mechanical origin point ;

P2: second reference point ;

P_: default is P2 ;

Description:

for the convenience that change tool and check, we use parameter to set a reference point to suitable position, it can let tool need not return to mechanical zero point, increase efficiency in changing the tool, the usage of this command is the same as G28 only expect returned point. Floating reference position return command, usually use in the position of automatically change the tool differ from the origin point. Movement mode G00.

<Notice> usually this command use in automatically change the tool, for safety, before do G30, need to cancel the tool compensation function.

Example:

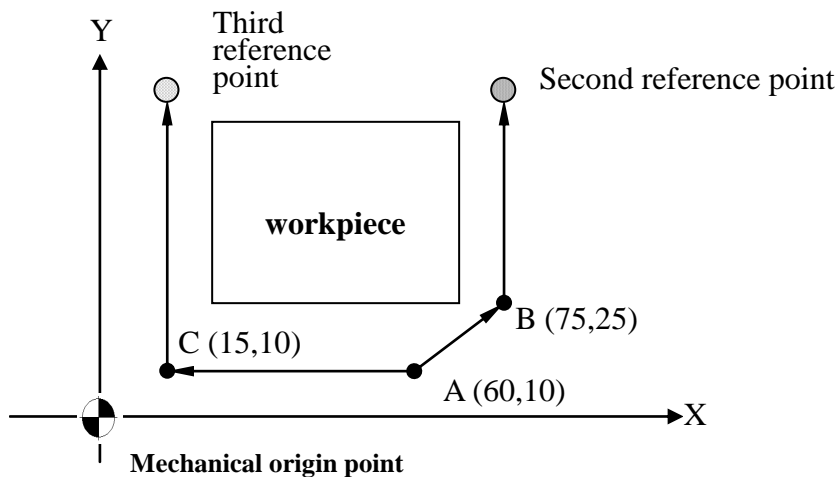

Program description: presume tool is in A (60,10)

1. to second reference point
G30 P2 X75.0 Y25.0 ; //A→B→ 2nd reference point
2. to third reference point
G30 P3 X15.0 Y10.0 ; //A→C→ 3rd reference point

1.2.16 G31: SKIP FUNCTION

Command form:

G31 X__ Y__ Z__ F__;

X, Y, Z: specified point

F: feedrate

Description:

skip command use in a unknown program point, and it specify that point, when measurement runs into impede, when machine get skip signal, LADDER C BIT ON, G31 will record the present mechanical position and interrupt motion of G31, run next block.

Example 1: incremental command(G91)

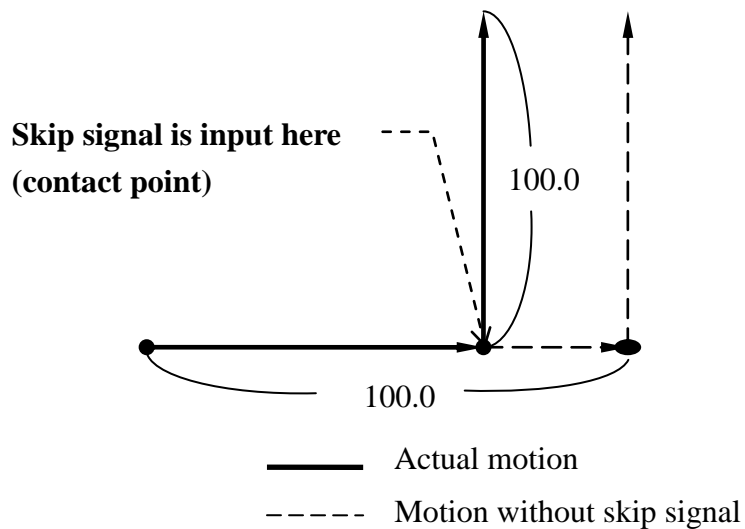

Program description:

N001 G31 G91 X100.0 F100; //original motion until run into impede
N002 Y100.0; //use contact point to be opposite coordinate, change path to specified position, it does not wait to the finished of front block

Example 2: absolute command for 1 axes(G90)

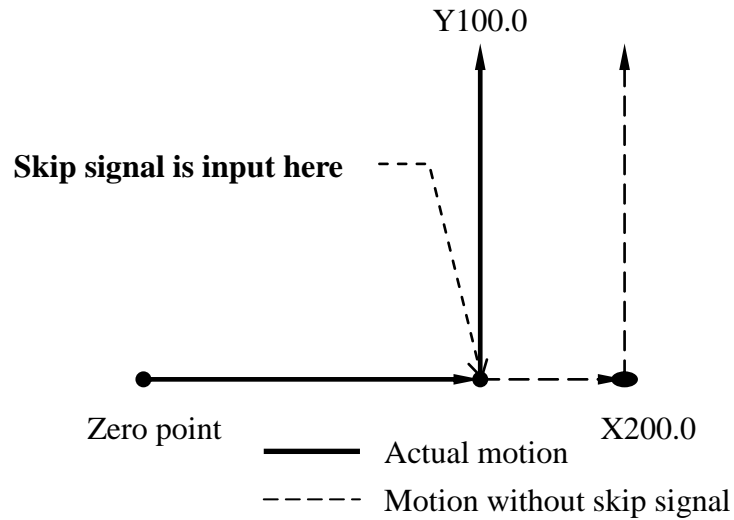

Program description:

```
N001 G31 G90 X200.0 F100; //original path until running into impede
N002 X200.0 Y100.0; //use zero point to be the relative coordinate to
change the path to the specified position, and it does not wait to the
finished of front block.
```

Example 3: absolute command for 2 axes(G90)

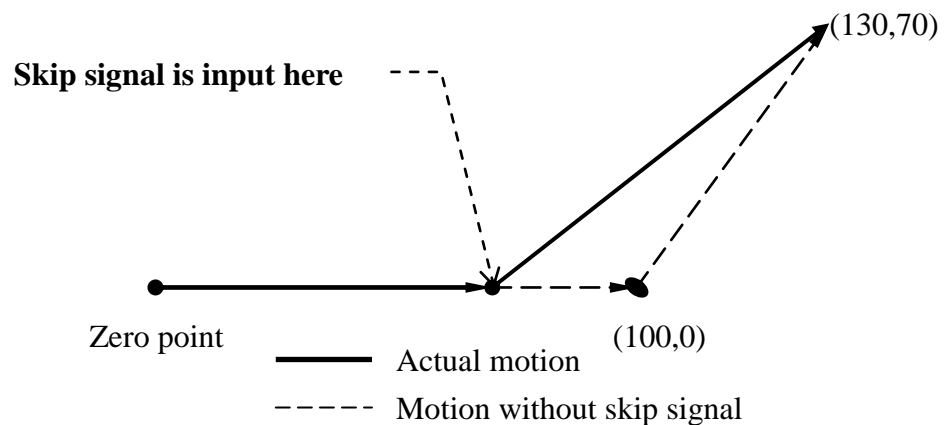

Program description:

```
N001 G31 G90 X100.0 F1000; // original path until running into
impede
```

N002 X130.0 Y70.0; // use zero point to be opposite coordinate to change the path to specify position, it does not wait to the finished of front block

1.2.17 G33: THREAD INTERPOLATION

Command form:

G33 Z__ F__ ;

Z: Absolute command (G90), coordinates of Z axis for end point;
Incremental command (G91), for length of thread in axis direction;
F: the thread of a screw (0.01mm);

Description:

When spindle turned, tool feeds in Z axis direction at the same time. After repeating many times, there is inertia lag of the spindle rotation at thread interpolation finishing. They will produce somewhat incorrect leads at start and end points of a thread cut. In order to compensate this, thread cutting length should be specified longer than required, in thread interpolation, limit of spindle speed(R) is:

$$1 \leq \text{spindle speed}(R) \leq \frac{\text{Max feedrate}}{\text{thread lead}}$$

R: spindle speed(rpm)

Thread lead(F): mm or inch

Feedrate: mm/min or inch/min

Notes:

Max feedrate can be setting by parameter #405.

Acceleration and deceleration time of thread interpolation can be setting by parameter #409.

Example:

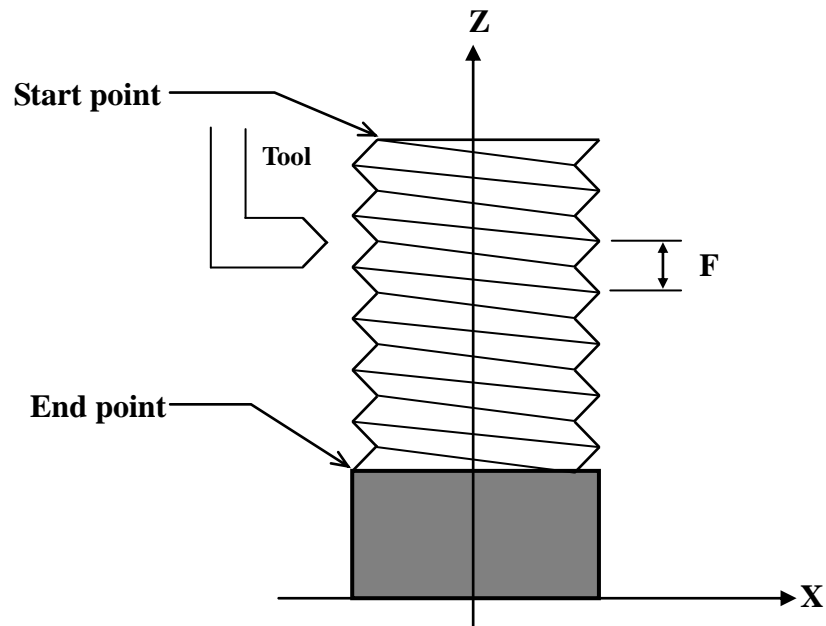

Program form:

```
G33 Z10.0 F1.5 ;
```

//thread cutting at a pitch of 1.5mm, the end is at Z axis 10mm

1.2.18 G37: AUTOMATIC TOOL LENGTH

MEASUREMENT - I

Command form:

G37 Z_ [R_] [D_] [F_] [P_] ;

Z: Absolute command for end point of Z in program coordinates.

R: Measuring distance, incremental value from Z position. Value of Pr4055 will be used if R is not defined.

D : Probe overtravel distance. Value of Pr4056 will be used if D is not defined.

F: Measuring federate. Value of Pr4057 will be used if F is not defined.

P: Reference point P. Value of Pr4058 will be used if P is not defined.

This action of reference point return will not be executed if Pr4058 is used and is not set 1~4.

Description:

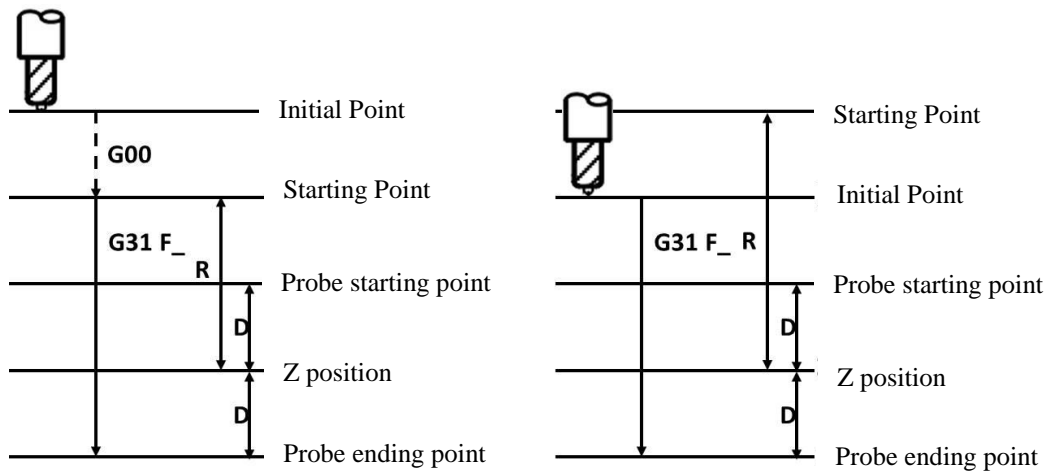

Starting point is lower than initial point

Starting point is higher than initial point

3. Return to P reference point with G30. G30 will not be executed if P is not defined.
4. Rapid move Z to starting point.
5. Move Z to probe starting point with G31
6. Move Z to probe ending point with G31, and proceed with tool length measurement.
7. Automatic tool length measurement complete, the tool length shall be defined to corresponding tool automatically.

Note:

1. Start from:

-SUPER/10s/20s : 10.116.10C

-11s/21s : 2.2.3

2. Please install the probe before the automatic tool measurement. It is recommended to insert the probe location to reference point P via Pr2801~2860.

3. The override is defined a 100% during automatic tool measurement.

4. The MPG offset of Z will be reset once complete the tool length measurement.

Alarms

5. [MAR-330 Z min. coordinate set error alarm!] shall occur if Z is not defined.

6. [MAR-333 Z start point error alarm!] shall occur if Z initial point is lower than Z starting point.

7. [MAR-334 Without issue H code before G code tool length measurement] shall occur if H word is not defined before automatic tool measurement.

8. [MAR-335 measure position setting error, measure signal has being triggered] shall occur if probe signal activated during Z axis move from starting point to probe starting point.

9. [MAR-336 measure position setting error, measure signal hasn't being triggered] shall occur if probe signal is not activated once Z axis reach probe ending point.

Program form:

```
G30 P2 X75.0 Y25.0; // return to reference point 2
```

```
M06 T1; // change to T1
```

```
H1; // define the tool length compensation H1
```

```
G37 Z-150; // move Z axis to -150.
```

```
M06 T2; // change to T2
```

```
H2; // define the tool length compensation H2
```

```
G37 Z-150; // move Z axis to -150.
```

```
M06 T3;           // change to T3
H3;              // define the tool length compensation H3
G37 P2 Z-200.;  // return to reference point 2, move Z to -200.
```

1.2.19 G37.1: AUTOMATIC TOOL LENGTH

MEASUREMENT - II

Command form:

G37 [Z_] [R_] [F_] [P_] [Q_];

Z: Absolute command for end point of Z in mechanical coordinates.

Value of Pr4057 will be used if Z is not defined.

R: Measuring distance, incremental value from Z position. Value of Pr4055 will be used if R is not defined.

F: Measuring federate. Value of Pr4057 will be used if F is not defined.

P: Reference point P. Value of Pr4058 will be used if P is not defined.

This action of reference point return will not be executed if Pr4058 is used and set to 0.

Q: Safety point. The control shall retract Z to machine zero if Q is not defined.

Description:

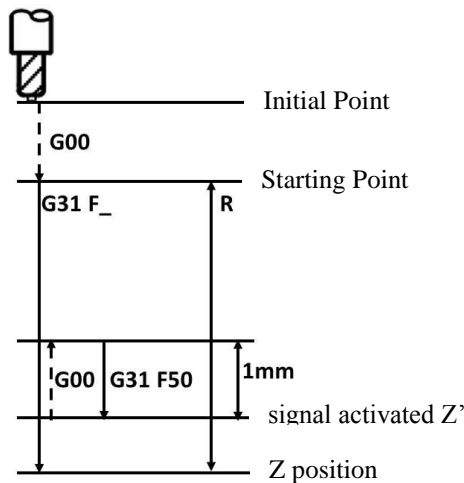

Starting point is lower than initial point

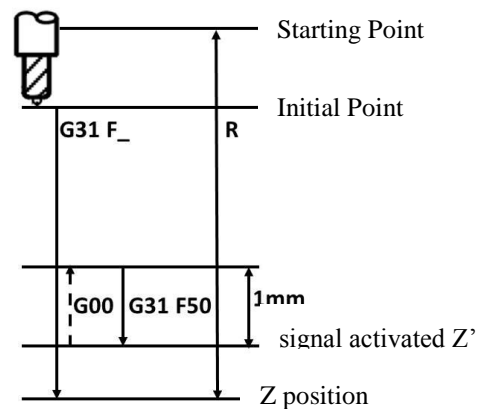

Starting point is higher than initial point

1. M90 enable the mist function
2. Return to P reference point with G30. G30 will not be executed if P is not defined.

1. Rapid move Z to starting point.
2. M91 disable the mist function

3. Move Z to defined Z position with G31
4. Retract Z axis for 1mm with G00 once probe signal activated
5. Move Z to defined Z position with G31 F50, and proceed with tool length measurement.
6. Automatic tool length measurement complete, the tool length shall be defined to corresponding tool automatically.
7. Return Z axis to safety point or machine zero.

Note:

1. Start from:
 - SUPER/10s/20s : 10.116.10C
 - 11s/21s : 2.2.3
2. Please install the probe before the automatic tool measurement. It is recommended to insert the probe location to reference point P via Pr2801~2860.
3. The override is defined a 100% during automatic tool measurement.
4. The MPG offset of Z will be reset once complete the tool length measurement.

Alarms

1. [MAR-330 Z min. coordinate set error alarm!] shall occur if Z is not defined.
2. [MAR-333 Z start point error alarm!] shall occur if Z initial point is lower than Z starting point.
3. [MAR-334 Without issue H code before G code tool length measurement] shall occur if H word is not defined before automatic tool measurement.
4. [MAR-336 measure position setting error, measure signal hasn't being triggered] shall occur if probe signal is not activated once Z axis reach probe ending point.

Program form:

```
G30 P2 X75.0 Y25.0; // return to reference point 2
M06 T1; // change to T1
H1; // define the tool length compensation H1
G37.1 Z-150; // move Z axis to -150.
```

```
M06 T2;           // change to T2
H2;              // define the tool length compensation H2
G37.1 Z-150;     // move Z axis to -150.

M06 T3;           // change to T3
H3;              // define the tool length compensation H3
G37.1 P2 Z-200.; // return to reference point 2, move Z to
-200.
```

1.2.20 G40/G41/G42: CUTTER COMPENSTAION

Command form:

$$\left\{ \begin{array}{l} G41 \\ G42 \end{array} \right\} X_ Y_ Z_;$$

G40 ;

G41: cutter compensation left.

G42: cutter compensation right.

G40: cutter compensation cancel.

X, Y: the end coordinate of each axis.

D: code for specifying as the cutter compensation value.

Description:

In general, when the tool is moved, if tool center is cutting along the workpiece, and the tool radius is overcut. In cutter compensation, the tool moved, the tool path can be shifted by the radius of tool. It can let the shape which is after process is equal with layout. Therefore we can enter the size of layout, and match this function, to get the right size of workpiece, we can ignore tool radius in the program.

Example:

1. Cutter compensation:

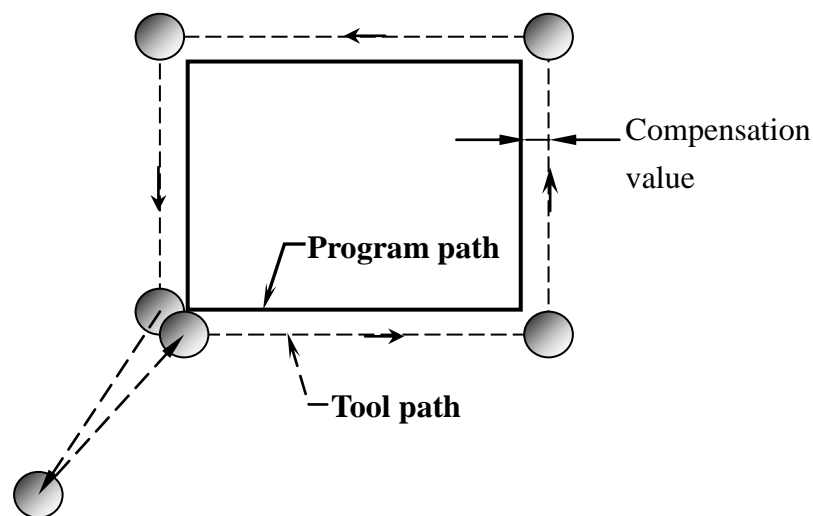

2. Direction decision of cutter compensation:

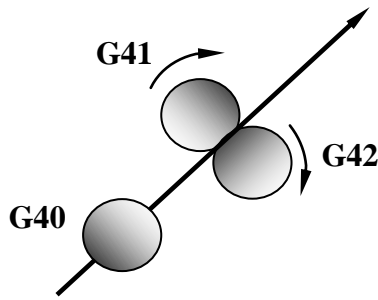

Compensation value	Positive	Negative
G41	Compensation left	Compensation right
G42	Compensation right	Compensation left

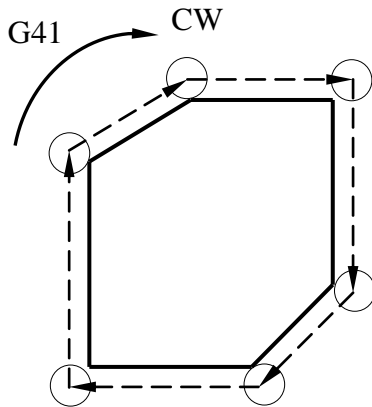

a. G41-outline cut (CW)

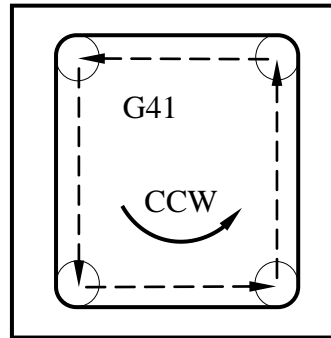

b. G41-inline cut (CCW)

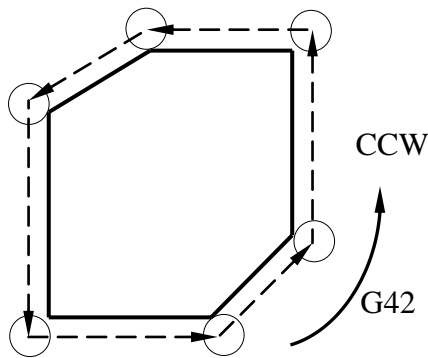

c. G42-outline cut (CCW)

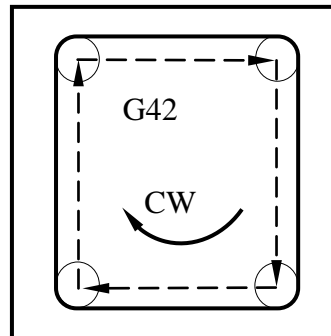

d. G42-inline cut (CW)

3. cutter compensation of corner interpolation:

- When the corner: $90^\circ \leq \alpha < 180^\circ$

i. straight line \rightarrow straight line

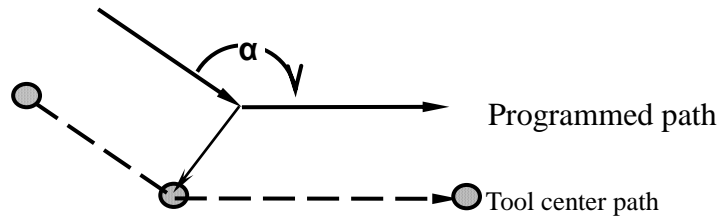

ii. straight line \rightarrow arc

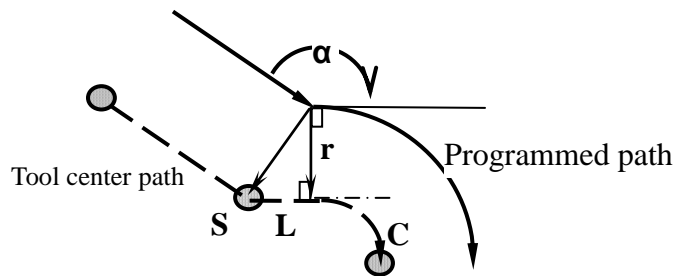

iii. arc \rightarrow straight line

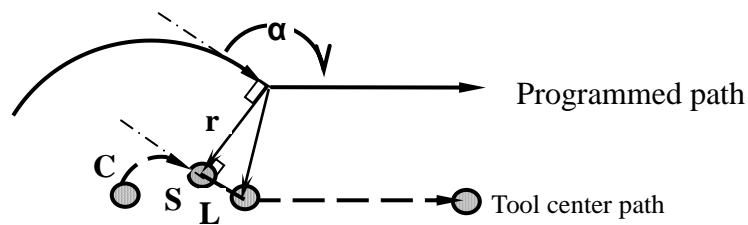

iv. arc \rightarrow arc

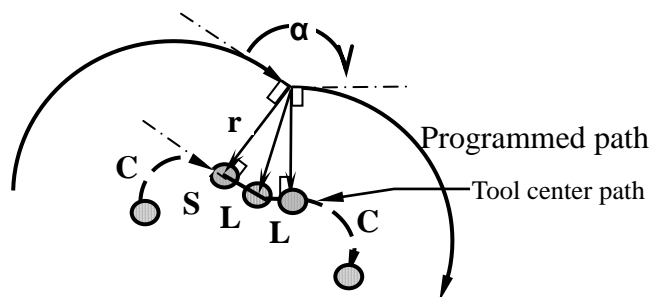

■ When corner $\alpha < 90^\circ$

v. straight line \rightarrow straight line

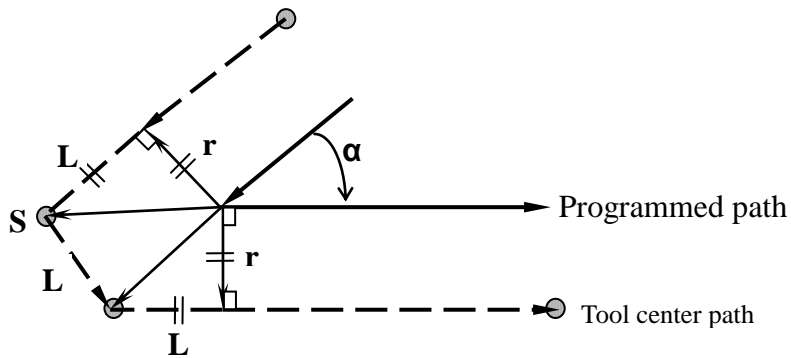

vi. straight line \rightarrow arc

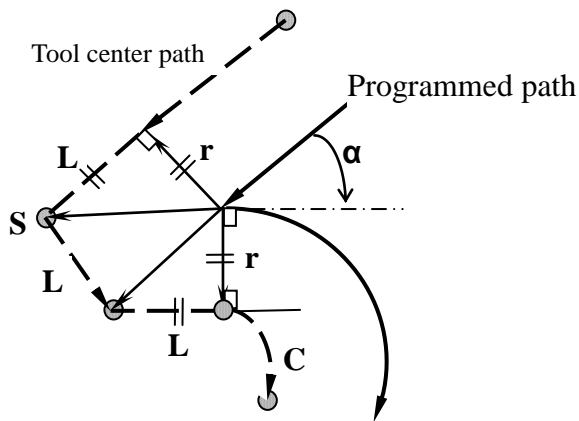

vii. arc \rightarrow straight line

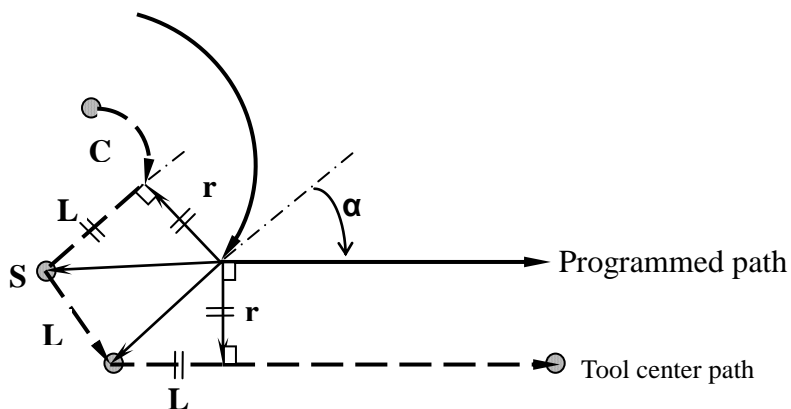

viii. arc → arc

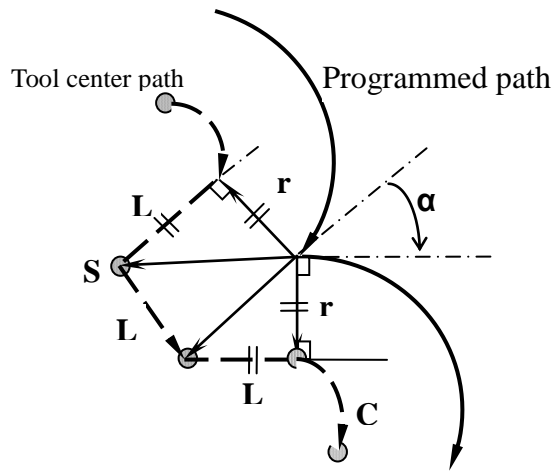

Notes:

when process a fillet, if the width less than twice of tool, than system will send the alarm because of over cutting.

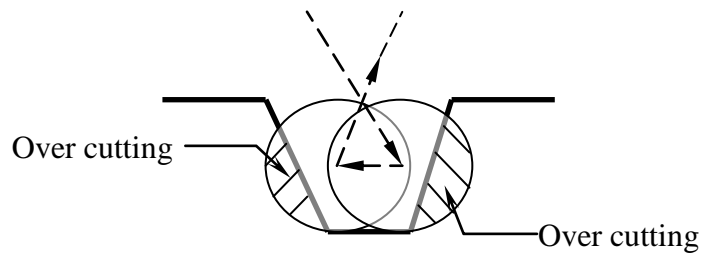

if under MDI mode, can not use cutter compensation.

G41/G42 and G40 can not be used with G02 and G03 in the same block, only can use with G00 and G01 in the same block.

when processing the step shape workpiece, if the step higher than workpiece radius ,then system will send alarm because of over cutting.

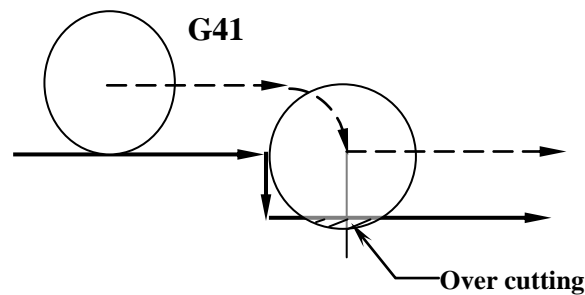

Program example:

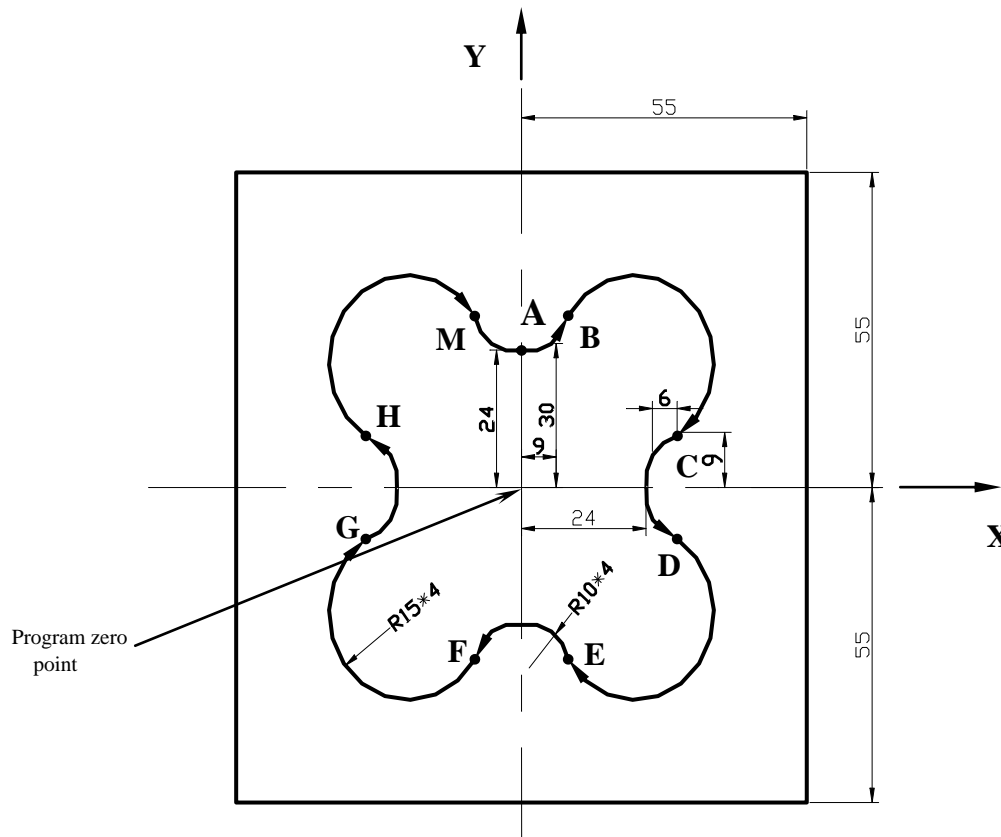

Program description:

```

N001 T1 S1000 M03 ; //tool NO.1(diameter 10mm), spindle 1000rpm
(CW)
N002 G00 X0.0 Y0.0 Z10.0 ; //positioning above programmed zero
point
N003 M08 ; //open cutting liquid
N004 G90 G01 Z-10.0 F600 ; //linear interpolation to bottom of
workpiece, feedrate 600mm/min
N005 G42 Y24.0 D01 ; //cutter compensation left, program zero
point→A
N006 G03 X9.0 Y30.0 R10.0 ; //A→B circular interpolation (CCW)
N007 G02 X30.0 Y9.0 R15.0 ; //B→C circular interpolation (CW)
N008 G03 X30.0 Y-9.0 R10.0 ; //C→D circular interpolation (CCW)
N009 G02 X9.0 Y-30.0 R15.0 ; //D→E circular interpolation (CW)
N010 G03 X-9.0 Y-30.0 R10.0 ; //E→F circular interpolation (CCW)
N011 G02 X-30.0 Y-9.0 R15.0 ; //F→G circular interpolation (CW)
N012 G03 X-30.0 Y9.0 R10.0 ; //G→H circular interpolation (CCW)
N013 G02 X-9.0 Y30.0 R15.0 ; //H→M circular interpolation (CW)

```

N014 G03 X0.0 Y24.0 R10.0 ; //M→A circular interpolation (CCW)
N015 G00 Z10.0 ; //Z axis rise, return to start point
N016 G40 X0.0 Y0.0 ; //cutter interpolation cancel, return to start
point
N017 M09 ; //cutting liquid OFF
N018 M05 ; //spindle stop
N019 M30 ; //program end

1.2.21 G43/G44/G49: TOOL LENGTH

COMPENSATION

Command form:

$$\left\{ \begin{array}{l} G43 \\ G44 \end{array} \right\} Z_ H_;$$

G49 ;

G43: compensation along positive direction ;

G44: compensation along negative direction ;

G49: compensation cancel ;

Z: Z axis end coordinates ;

H: tool number ;

Description:

when use machine to process each workpieces, there are many tools that we use, and the length of each tool is different, during programming, after change the tool the difference between tool length will make Z axis direction have errors, tool length compensation(G43/G44) is used to Z axis position compensation and to correct the difference between tool length.

Compensation value setting:

(consult “milling machine controller manual”)

First way:

use manual that let the tool go down from machine zero point of Z axis until it touch the surface of workpiece, enter the distance to tool setup in operation interface and do this for each tools. Set the number of tool in H value of program command form.

Second way:

choose a tool to be basis, in system operation interface do tool length adjust in work coordinates setting to G54 system, after that we can use it to be the difference between tools of basis tool, we can convert length of compensation.

Example:

	Compensation value	Positive	Negative
	G43	Positive direction	Negative direction
	G44	Negative direction	Positive direction

Example:

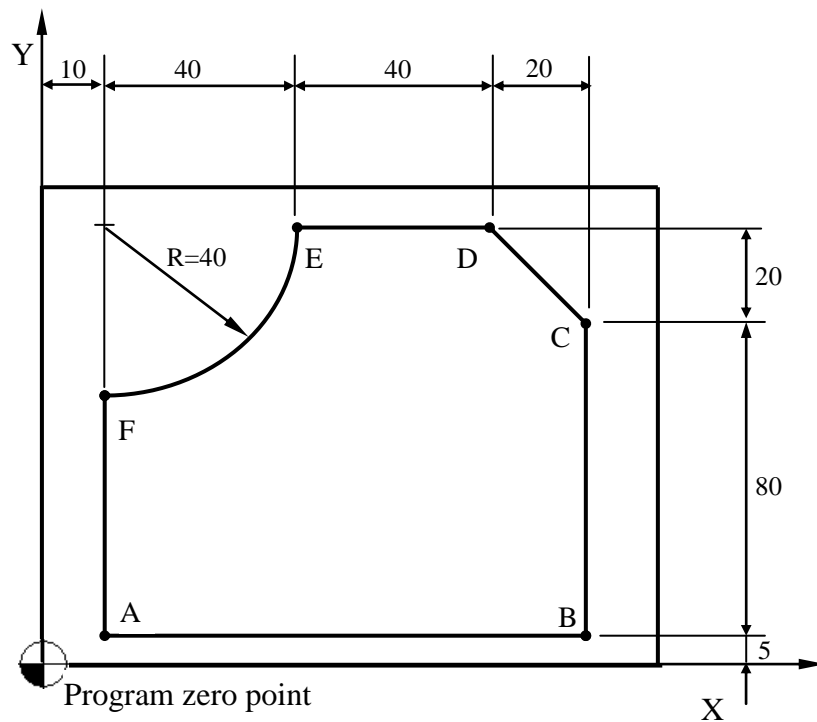

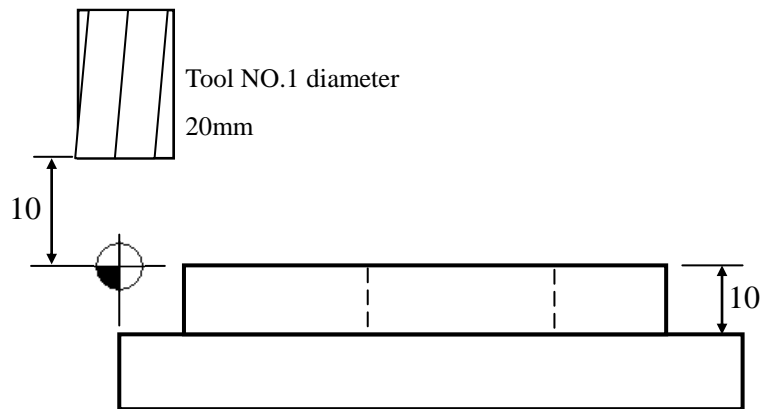

Program description:

```

T1 S1000 M03 ; //use tool NO.1(diameter 20mm), spindle
1000rpm(CW)
G42 D01 ; //tool radius compensation right(D01=10)
G00 X10.0 Y5.0 Z15.0 ; //positioning above A point
G43 H01 ; //tool length compensation positive(H01=-10)
G01 Z-10.0 ; //linear interpolation to bottom of A point
X110.0 ; //A→B
Y85.0 ; //B→C
X90.0 Y105.0 ; //C→D
X50.0 ; //D→E
G02 X10.0 Y65.0 R40.0 ; //E→F
G01 Y5.0 ; //F→A
G00 Z15.0 ; //positioning return above A point
G40 G49 ; //compensation cancel
M05 ; //spindle stop
M30 ; //program end

```

1.2.22 G51/G50: SCALING

Command form:

$$X_ Y_ Z_ \left\{ \begin{array}{l} I_ J_ K_ \\ P_ \end{array} \right.$$

X, Y, Z: center coordinate value of scaling ;

I, J, K: scaling magnification for X axis Y axis and Z axis respectively ;

P: scaling magnification for X axis Y axis and Z axis are the same magnification ;

Description: G51 let the tool path magnify and reduce at our own choose.

G50: scaling cancel.

Example:

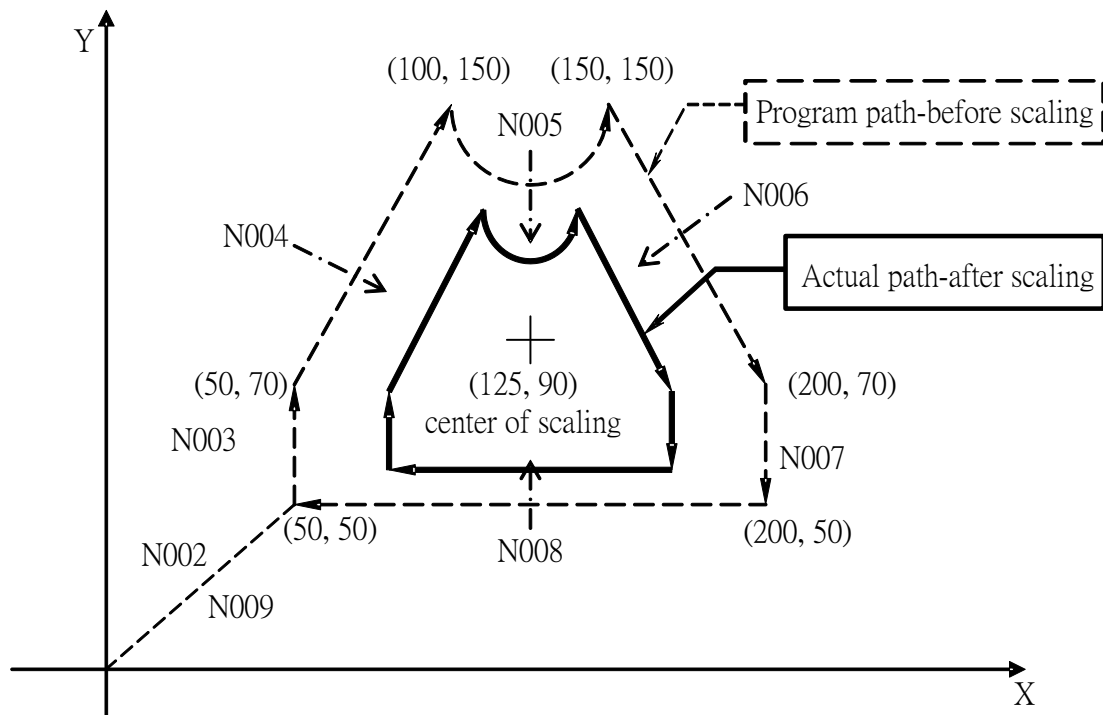

Program description:

N001 G00 X50.0 Y50.0 ; //positioning

N002 G51 X125.0 Y90.0 P0.5 ; //decide center of scaling X125,Y90
scaling magnification value 0.5, do scaling to steps N003~N009

N003 G01 Y70.0 F1000 ; //linear interpolation, feedrate 1000mm/min

N004 X100.0 Y150.0 ;
N005 G03 X150.0 I25.0 ; //circular interpolation, radius 25mm ;
N006 G01 X200.0 Y70.0 ; // linear interpolation
N007 Y50.0 ;
N008 X50.0 ;
N009 G00 X0.0 Y0.0 ; //return
N010 G50 ; //scaling cancel
N011 M30 ; //program end

1.2.23 G51.1/G50.1: PROGRAMMABLE MIRROR

IMAGE

Command form:

G51.1 X__Y__Z__;

G50.1;//programmable mirror image cancel

X, Y, Z: mirror point (axis) coordinate value.

Description:

when cut symmetry shape, we only need one program between left side or right side, and use this function we can process another side. G51.1 specify point(position) and axis of symmetry for producing a mirror image

if there is only one axis specify mirror image on specified plane, circular、tool length compensation or the direction of coordinate rotation or direction of compensation, all of those execute reverse.

because of this function use in part coordinates, when counter reset or work coordinates change, center of mirror image is changed.

G28, G30 in programmable mirror image, before the mid-point, programmable mirror image is effective, after the mid-point, programmable mirror image is not execute.

execute G29 in programmable mirror image, that is effective to mirror image of mid-point.

Note:

Execute mirror image cancel out of the center point, absolute value can not match with mechanical position, as the below PIC (this status continues until executing G90、G28 or G30). If you specify the center of mirror image again in the absolute static status, it will be specified to a unable expect position. Please use absolute positioning after mirror image cancel.

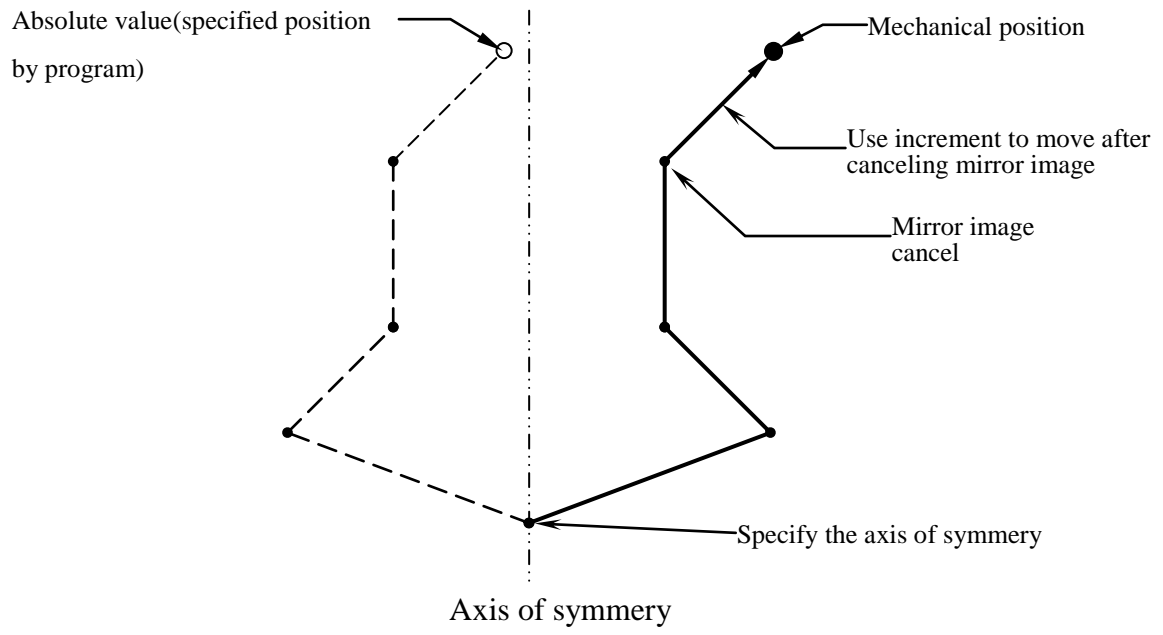

Example 1:

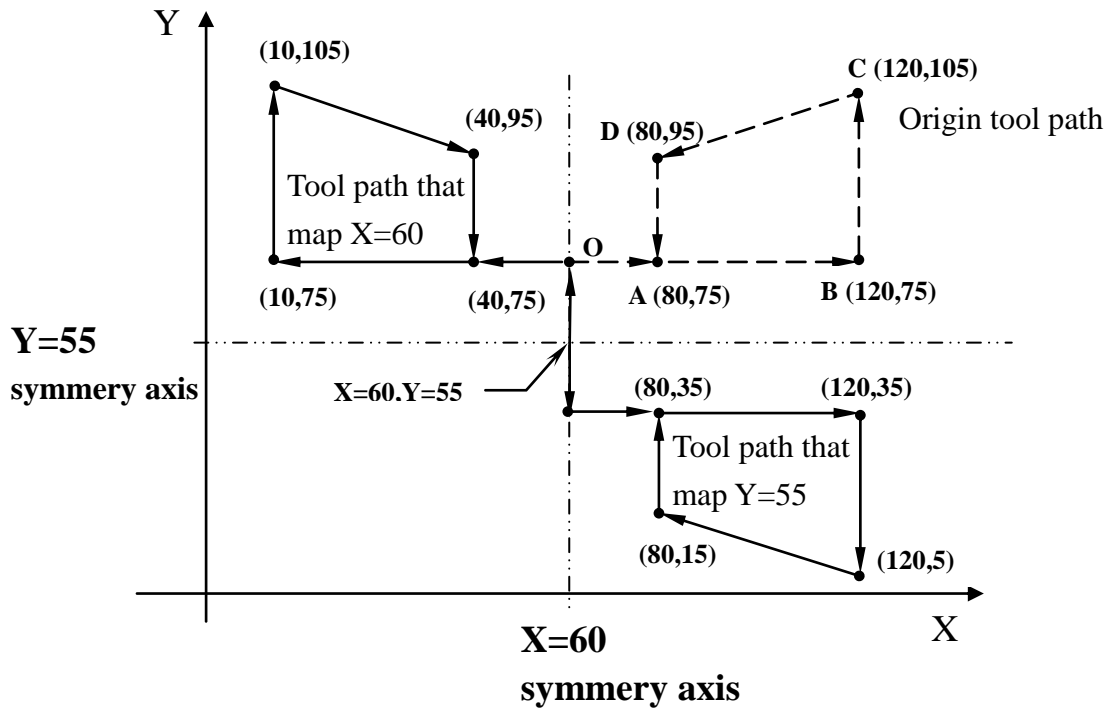

Program description:

```

N001 T1 S1000 M03 ; //use tool NO. 1, 1000rpm(CW)
N002 M98 H100 ; //execute sub-program
N003 G51.1 X60.0 ; //execute programmable mirror image that
symmetry axis X=60
N004 M98 H100 ; // execute sub-program
N005 G50.1 ; //programmable mirror image cancel
N006 G51.1 Y55.0 ; //execute programmable mirror image that
symmetry axis Y=55
N007 M98 H100 ; // execute sub-program
N008 G50.1 ; // programmable mirror image cancel
N009 M05 ; //spindle stops
N010 M30 ; //program ends

```

```

N100 ; //sub-program list
G00 X60.0 Y55.0 ; //positioning to specified point
G01 Y75.0 ; //linear interpolation to O point
X80.0 ; //O→A
X120.0 ; //A→B
Y105.0 ; //B→C
X80.0 Y95.0 ; //C→D

```

Y75.0 ; //D→A

M99 ; //sub-program ends

Example 2: processing example

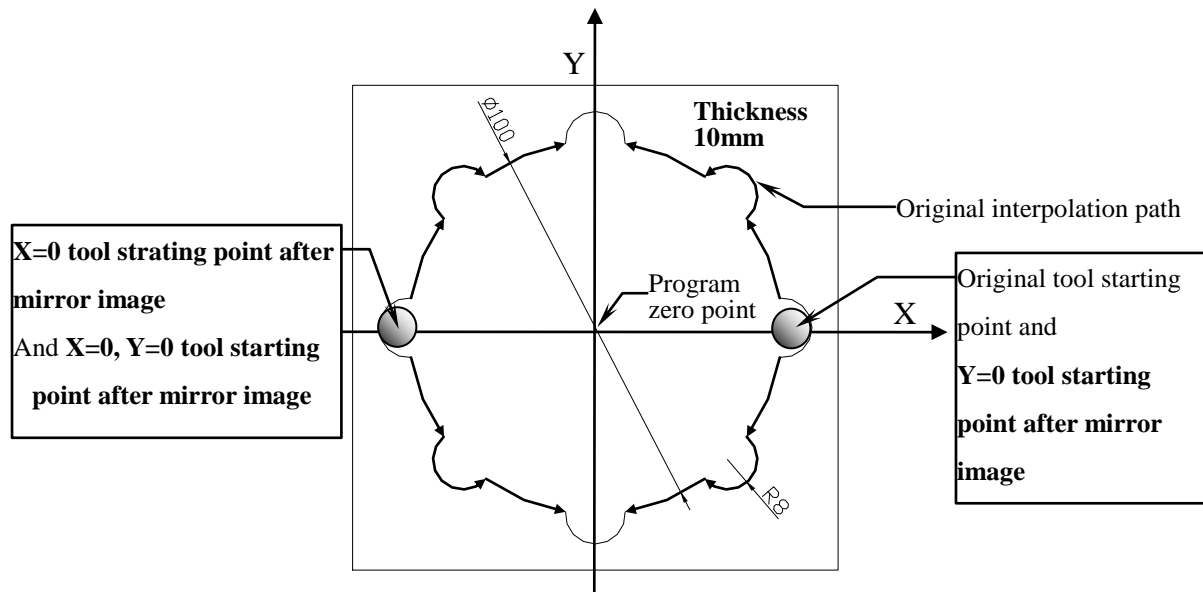

Program description: process a trough that flower shaped

```

N001 T1 S1000 M03 ; //tool No.1(diameter 10mm), 1000rpm(CW)
N002 G41 D01 ; //set cutter compensation left of tool No.1(D01 = 5)
N003 M98 H100 ; //execute sub-program
N004 G51.1 X0.0 ; //execute programmable mirror image at symmery
axis X=0
N005 M98 H100 ; //execute sub-program
N006 G50.1 ; //programmable mirror image cancel
N007 G51.1 X0.0 Y0.0 ; // execute programmable mirror image at
symmery point X=0, Y=0
N008 M98 H100 ; // execute sub-program
N009 G50.1 ; // programmable mirror image cancel
N010 G51.1 Y0.0 ; // execute programmable mirror image at symmery
axis Y=0
N011 M98 H100 ; // execute sub-program
N012 G50.1 ; // programmable mirror image cancel
N013 G40 ; //cutter compensation cancel
N014 M05 ; //spindle stops
N015 M30 ; //program ends

```

Sub-program

```

N100 ; sub-program list
G00 X58.0 Y0.0 Z10.0 ; //positioning to the above of starting position

```

```
G01 Z-10.0 ; //linear interpolation to bottom of workpiece
G03 X49.36 Y7.9744 R8.0 ; //circular interpolation(CCW), radius 8mm
G03 X40.5415 Y29.2641 R50.0 ; // circular interpolation(CCW), radius
50mm
G03 X29.2641 Y40.5415 R8.0 ; // circular interpolation(CCW), radius
8mm
G03 X7.9744 Y49.36 R50.0 ; // circular interpolation(CCW), radius
50mm
G03 X0.0 Y58.0 R8.0 ; // circular interpolation(CCW), radius 50mm
G00 Z10.0 ; //positioning to above of end point
M99 ; //sub-program end, continue to execute main program
```

1.2.24 G52: LOCAL COORDINATE SYSTEM

Command form:

G52 X__ Y__ Z__ ;

X、Y、Z: coordinate values

Description:

specify a work coordinate system(G54~G59), when workpiece need to set another coordinate system, that coordinate system is local coordinate system.

G52 X0.0 Y0.0 Z0.0: cancel the coordinate system

Coordinate system:

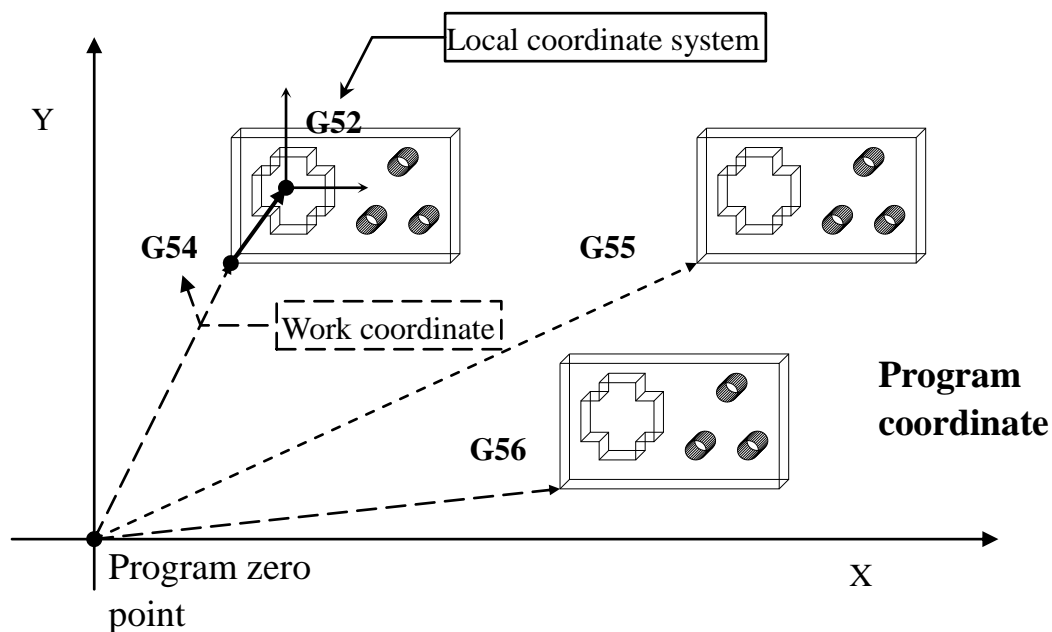

Example:

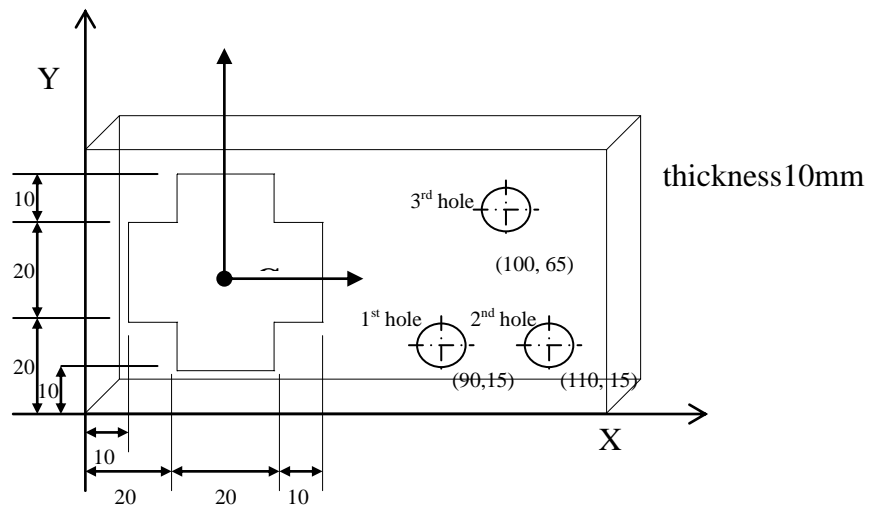

Program description:

```

N001 T1 S1000 M03 ; //tool No.1(diameter 10mm), spindle 1000rpm
(CW)
N002 G54 X0.0 Y0.0 Z0.0 ; //specify work coordinate (G54)
N003 G00 X90.0 Y15.0 Z10.0 ; //positioning to above of specified
position
N004 G43 H01 ; //tool length compensation (tool No.1)
N005 G99 G81 Z-15.0 R2.0 F1000 ; //execute drilling cycle, stop at R
point when return, feedrate 1000mm/min, drill 1st hole
N006 X110.0 ; //drill 2nd hole
N007 X100.0 Y65.0 ; //drill 3rd hole
N008 G80 ; //cancel cycle
N009 M05 ; //spindle stops
N010 G28 X0.0 Y0.0 Z10.0 ; //reference point return, X0.0,Y0.0,Z10.0
to be center point
N011 T2 M06 S1000 M03 ; //execute tool exchange(tool No.2 diameter
10mm), after finishing, spindle start to turn, 1000rpm(CW)
N012 G52 X30.0 Y30.0 Z0.0 ; //specify local coordinate zero point to
the work coordinate (G54) of X40.0,Y40.0,Z0.0(geometry center of
workpiece)
N013 G00 X0.0 Y0.0 Z10.0 ; //positioning to local coordinate
X0.0,Y0.0,Z10.0(above the hole)
N014 G01 Z-12.0 ; //linear interpolation to bottom of the hole

```

N015 G17 G41 D02 ; //cutter compensation left (tool No.2)
N016 G91 X20.0 ; //specify to use increment to interpolation
N017 Y10.0 ;
N018 X-10.0 ;
N019 Y10.0 ;
N020 X-20.0 ;
N021 Y-10.0 ;
N022 X-10.0 ;
N023 Y-20.0 ;
N024 X10.0 ;
N025 Y-10.0 ;
N026 X20.0 ;
N027 Y10.0 ;
N028 X10.0 ;
N029 Y10.0 ;
N030 G90 G00 Z10.0 ; //specify to use absolute positioning
N031 G52 X0.0 Y0.0 Z0.0 ; //cancel local coordinate
N032 G40 M05 ; //cancel compensation, spindle stops
N033 M30 ; //program ends

1.2.25 G53: MACHINE COORDINATE SYSTEM

SELECTION

Command form:

G53 X___ Y___ Z___ ;

X: move to specify machine coordinate of X position.

Y: move to specify machine coordinate of Y position.

Z: move to specify machine coordinate of Z position.

Description:

Machine origin point is the fixed origin point when factory build the CNC machine, this coordinate system is fixed ; when G53 is specified tool will move to the specified position on machine coordinate, when tool returns to machine zero point(0,0,0), this point is the origin point of machine coordinate system.

<Notes>:

1. G53 only effective in specified block ;
2. G53 only effective absolute mode(G90), not effective in increment mode(G91) ;
3. before specify G53, must cancel related cutter compensation ,tool length compensation or position compensation ;
4. before use G53 to set coordinate system, must set coordinate system on the basement of reference return position by manual.

Example:

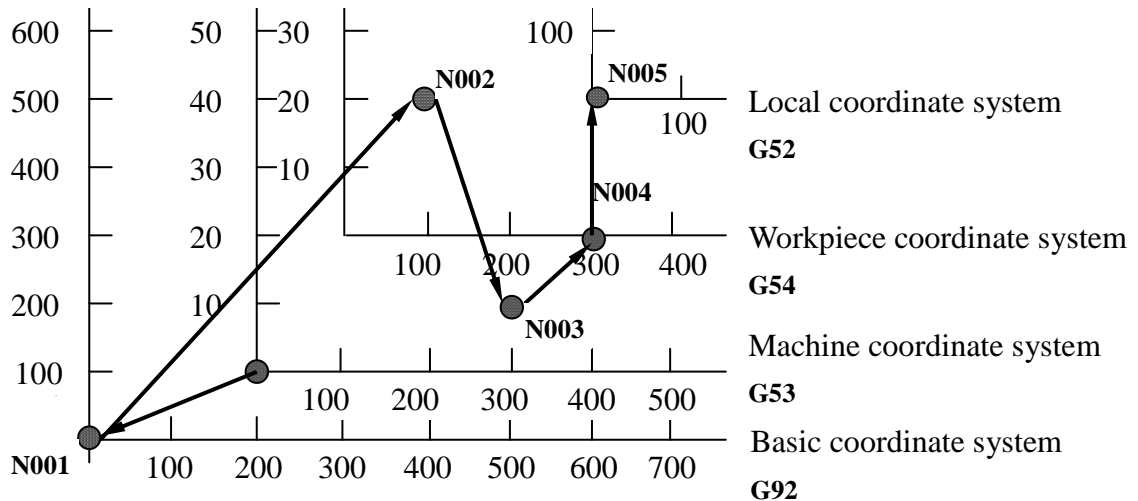

Program description:

```

N001   G92 X-200.0 Y-100.0 ; //specify to basic coordinate system
N002   G54 G90 X100.0 Y200.0 ; //to specified position on
workpiece coordinate system
N003   G53 X300.0 Y100.0 ; //to specified position on machine
coordinate system
N004   X300.0 Y0 ;
//because of G53 only effective in one block, this block continue G54
to the specified position on workpiece coordinate system
N005   G52 X300.0 Y200.0 ; //set local coordinate to specified
position on workpiece coordinate system
N006   X0.0 Y0.0 ;

```

1.2.26 G54...G59.9: WORKPIECE COORDICATE

SELECTION

Command form:

{	G54	
	G55	
	G56	
	G57	
	G58	
	G59	X _Y _Z _;
	G59.1	
	G59.2	
	:	
	:	
	:	
	G59.9	

G54: 1st workpiece coordinate system

:

:

G59: 6th workpiece coordinate system

G59.1: 7th workpiece coordinate system

:

:

G59.9: 15th workpiece coordinate system

X, Y, Z: move to specified position on setting workpiece system ;

Description:

In general when we operate numerical machine, if there are many workpieces on the machine, we can use workpiece coordinate system G54 to G59 six G codes G59.1~G59.9 to present 15 different coordinate systems, it is convenient to specify each workpiece position on machine coordinate, and it is more convenient to our processed. Use parameter #3229 to 「disable workpiece coordinate system」 (0: enable; 1: disable).

※G54.....G59.9 settings:

“setting workpiece coordinate system” in operation interface, setup G54 ...G59.9 by each other. (consult ”milling machine controller operation manual”)

Example:

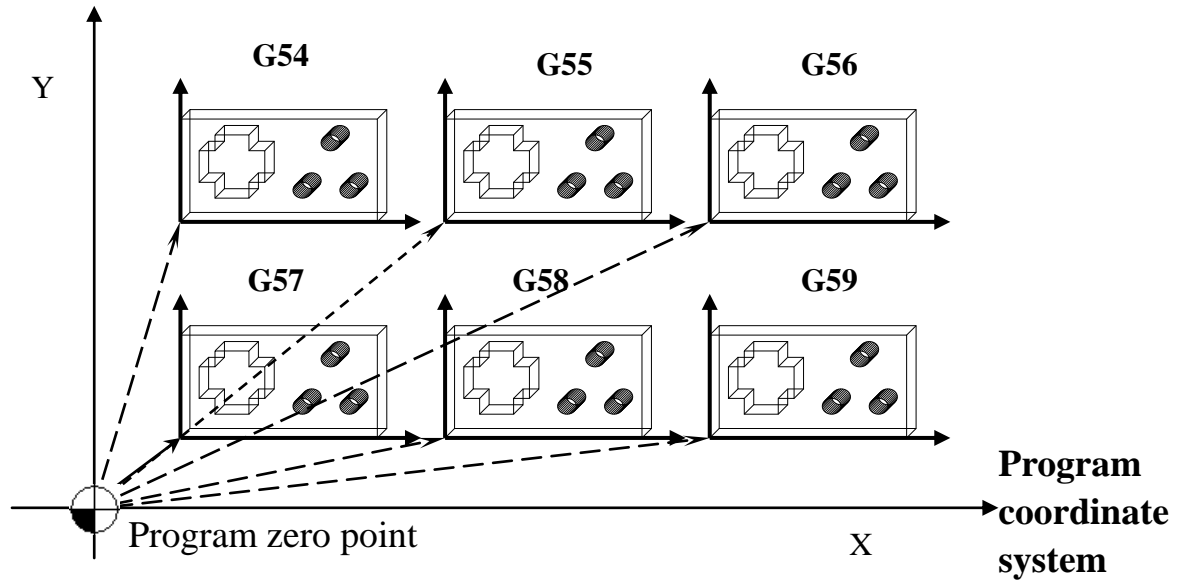

1.2.27 G64: CUTTING MODE

Command form:

G61 ; // exact-stop examination mode
 G62 ; // curved surface cutting mode
 G63 ; // tapping mode
 G64 ; // curved surface cutting mode
 G64;

Description:

G64 is similar to G09, G61 in usage, NC use smooth cutting face mode to cut. This mode does not decelerate and stop between G61 and reverse cutting feed block, the mode will continue to execute next block. G64 can be canceled by G61, G62, G63.

Command name	G code	range	description
Exact stop	G09	Only effective in block with G09.	When tool decelerates at the end of path, The precision error occurs at the corner when the tool direction turns. G09 is used to control the precision error.
Exact stop	G61	G61 is effective until we set G62, G63, G64.	G61 is similar to G09. The difference is G61 effective until we set G62, G63, or G64. Tool decelerates at the end of corner. When tool arrived at the terminal, a feedback signal is sent to ensure the position is in the setting range. The next path is executed after the feedback control.
	G62	G62 is effective until we set G61, G63, or G64.	Applicable to curved surface cutting. Tool does not decelerate at the end of path (refer to the speed command curve shown below) and continue execute next path.
	G63	G63 is effective until we set G61, G62, or G64.	Applicable to tapping. To synchronize spindle and feed axis. The relation between spindle and feed axis is

			determined by the ratio of spindle rotate speed and feedrate. During tapping, feed override and feed hold cannot be adjusted.
Cutting mode	G64	G64 is effective until we set G61 、 G62 、 G63.	Tool does not decelerate on the end of path, and continue to execute next path after to specified point.

1.2.28 G65: SIMPLE CALL

Command form:

G65 P__ L__ ;

P: number of the program to call ;

L: repetition count ;

Description:

After calling macro, P__ is called to execute and L__ indicates repeating times. But it is enable only in the block with G65.

Example:

```
G65 P10 L20 X10.0 Y10.0
```

```
//Call sub-program O0010 continuously 20 times, and set X=10.0 and Y=10.0 into sub-program.
```

1.2.29 G66/G67: MACRO CALL

Command form:

G66 P__ L__ ; macro call

G67 ; macro call cancel

P: number of the program to call ;

L: repetition count ;

Description:

After G66 is called, P__ is called to execute and L__ indicates repeating times. If there is a moving block, G66 block will be executed again after moving block ends until using G67 to cancel it.

Example:

G91

G66 P10 L2 X10.0 Y10.0 //repeat twice calling sub-program O0010 and set X=10.0 and Y=10.0 into sub-program.

X20.0 //Move to position X=20.0. After moving, call G66 P10 L2 X10.0 Y10.0.

Y20.0 //Move to position Y=20.0. After moving, call G66 P10 L2 X10.0 Y10.0.

G67 //Cancel macro call mode.

1.2.30 G68/G69: COORDINATE ROTATION

Command form:

(G17) G68 X_ Y_ R_; // start coordinate rotation

(G18) G68 Z_ X_ R_;

(G19) G68 Y_ Z_ R_;

G69; // Disable coordinate rotation

X_, Y_, Z_: absolute coordinate of center of rotation

R_: angle of rotation

Description

After coordinate rotation start, all movement command will rotate with rotation center, so the geometric figure rotate a angle. Rotation center only effective in absolute command, if all command is increment, the actual rotation center is the starting point of path.

Example 1:

```
G54 X0 Y0 F3000.;
G16; // start polar coordinates
G90 G00 X50. Y9.207 R8.; // positioning to starting point
M98 H100; // first process
G68 X0 Y0 R90.; // coordinate rotates 90°
M98 H100; // second process
G68 X0 Y0 R180.; // coordinate rotates 180°
M98 H100; // third process
G68 X0 Y0 R270.; // coordinate rotates 270°
M98 H100; // fourth process
G69; // coordinate rotation cancel
G15; // polar coordinate cancel
M02; // main program end
N100 // orbit sub-program start
G90 G01 X50. Y9.207 R8.;
G03 X50. Y80.793. R50.;
G03 X50. Y99.207 R8.;
M99; // orbit sub-program return
```

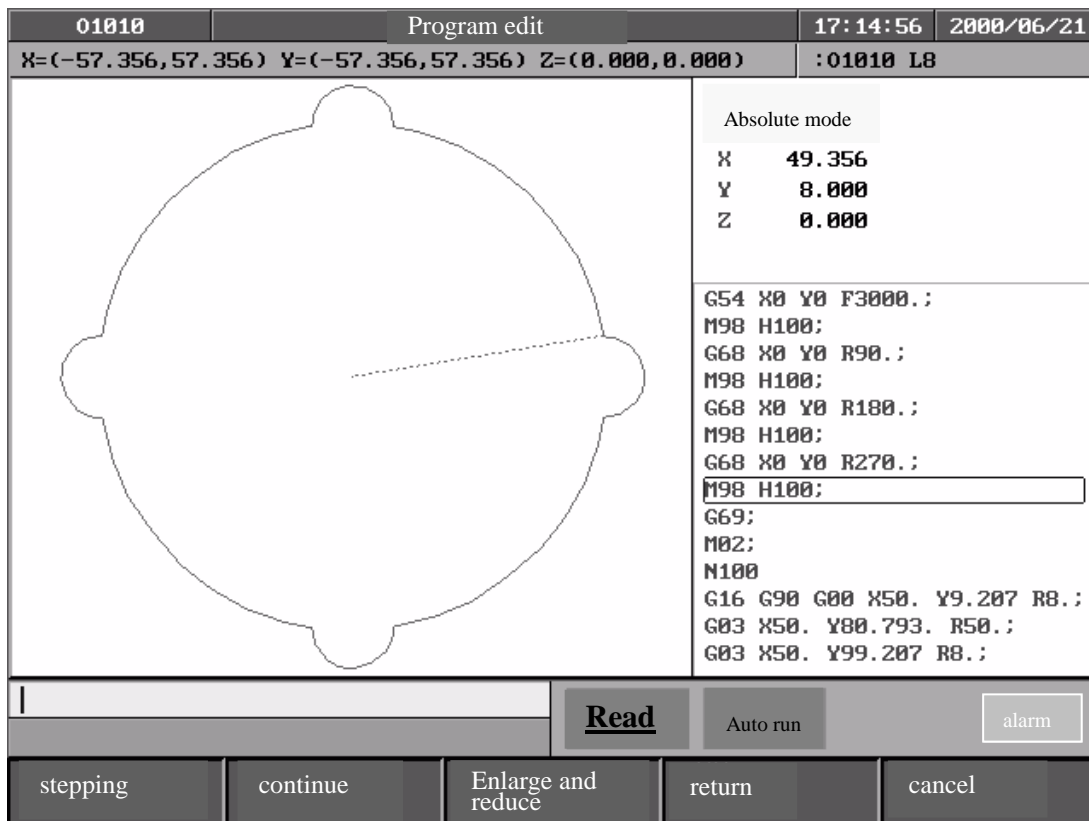

Example 2:

```

G54 X0 Y0 F3000.;
G16; // start polar coordinate
G90 G00 X50. Y9.207 R8.; // positioning to starting point
M98 H100; // first process
G68 X0 Y0 R45.; // coordinate rotates 45°
M98 H100; // second process
G68 X0 Y0 R90.; // coordinate rotates 90°
M98 H100; // thied process
G68 X0 Y0 R135.; // coordinate rotates 135°
M98 H100; // fourth process
G68 X0 Y0 R180.; // coordinate rotates 180°
M98 H100; // fifth process
G68 X0 Y0 R225.; // coordinate rotates 225°
M98 H100; // sixth process
G68 X0 Y0 R270.; // coordinate rotates 270°
M98 H100; // seventh process

```

```
G68 X0 Y0 R315.; // coordinate rotates 315°
M98 H100; // eighth process
G69; // coordinate rotates cancel
G15; // polar coordinate cancel
G00 X-80. Y0.
M98 H200; // process first "flower"
G51.1 Y-40.; // symmetry axis Y-40.
M98 H200; // process second "flower"
G50; // mirror image cancel
G90 G81 Z-20. R2. F1000. K0; // start G81 drilling cycle
G134 X0 Y0 I75. J30. K6; // circumference hole cycle
G137.1 X60. Y-60. I20. J-20. P3 K3; // chess type hole cycle
G80; // drilling cycle cancel
M02; // main program end
N100 // orbit sub-program
G90 G01 X50. Y9.207;
G03 X50. Y35.793 R50.;
G03 X50. Y54.207 R8.;
M99; // sub-program return
N200 // sub-program start (flower)
G90 G00 X-70. Y10.;
G91 G03 X-20. R10.;
G03 Y-20. R10.;
G03 X20. R10.;
G03 Y20. R10.;
M99; // sub-program return(flower)
```

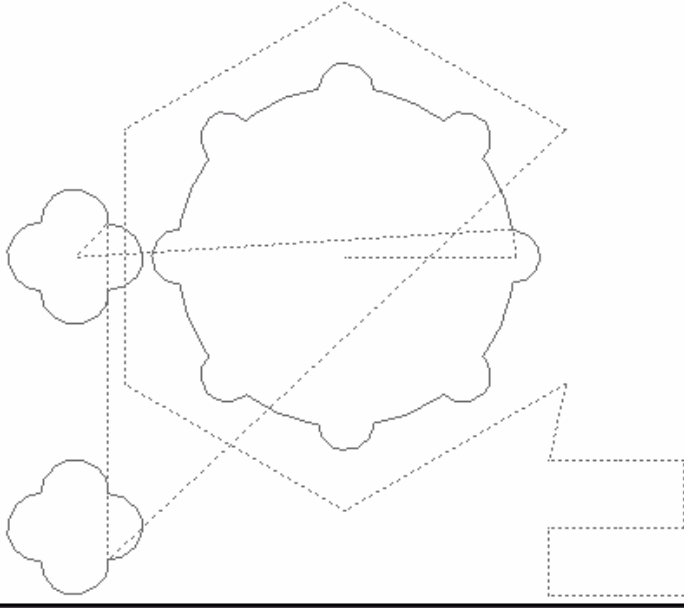
01013	Program edit	17:45:28	2000/06/21
X=(-100.000,100.000) Y=(-100.000,75.000) Z=(-20.000,2.00		:01013 L30	
		<p>Absolute mode</p> <p>X 100.000 Y -100.000 Z 2.000</p> <hr/> <p>G50 G81 Z-20. R2. F1000. K0; G134 X0 Y0 I75. J30. K6; <u>G137.1 X60. Y-60. I20. J-20.</u> G80; M02; N100 G90 G01 X50. Y9.207 R8.; G03 X50. Y35.793. R50.; G03 X50. Y54.207 R8.; M99; N200 G90 G00 X-70. Y10.; G91 G03 X-20. R10.;</p>	
		Read	Auto run <input type="button" value="alarm"/>
stepping	continue	Enlarge and reduce	return <input type="button" value="cancel"/>

1.2.31 G70/G71: UNIT SETTING OF INCH/METRIC SYSTEM

Command form:

G70;

G71;

Description:

G70: inch system

G71: metric system

After change inch/metric system, origin offset value of workpiece coordinate, tool data, system parameter, and reference point, all of that is still correct. System will deal the change of unit automatically. After change inch/metric system, item below will change as follow:

- Coordinate, unit of speed
- increment JOG unit
- MPG JOG unit

Decimal Point Input

When parameter is inputted by decimal point input, will to be the common measurement unit, mm, inch, sec...etc., if input by whole number, it will to be the Min unit that system default, μm , ms...etc.

example:

- decimal point: ○○.○○
- whole number: ○○○○

1.2.32 Cycle perform function:

G Code	Cutting	Bottom of the hole	Escape	Application
G73	Intermittent cutting feed	----	Speedy movement	High speed peck drill cycle
G74	Cutting feed	After stopping, spindle rotate clockwise	Cutting feed	Left hand tapping cycle
G76	Cutting feed	Spindle location stop and offset a displacement value	Speedy movement	Fine boring cycle
G80	----	----	----	Cycle cancel
G81	Cutting feed	----	Speedy movement	Drilling cycle
G82	Cutting feed	Dwell	Speedy movement	Drilling cycle of dwell on the hole bottom
G83	Intermittent cutting feed	----	Speedy movement	Peck drill cycle
G84	Cutting feed	Spindle reverse after dwell	Cutting feed	Tapping drilling cycle
G85	Cutting feed	----	Cutting feed	Drilling cycle
G86	Cutting feed	Spindle dwell	Speedy movement	Boring cycle
*G87	Cutting feed	Spindle rotate CW	Speedy movement	Fine boring cycle of back side
*G88	Cutting feed	Spindle stop after dwell	Manual movement	Fine boring cycle of half automation
G89	Cutting feed	Dwell	Cutting feed	Boring cycle of dwell on the hole bottom

Fixed cycle address and meaning:

Address	Address meaning
G	Selection of fixed cycle
X	Selection position of drilling point(increment or absolute)
Y	Selection position of drilling point(increment or absolute)
Z	Selection position of hole bottom(increment or absolute)

P	Dwell time when hole is in the bottom
Q	Cutting value in G73、G83, or specified movement value (increment) in G76、G87
R	Selection of R position(absolute or increment)
F	Selection of federate
K	Specify fixed cycle times 0~999

G17, G18, and G19 can set axis of drilling, list as below:

G Code	Plane	Axis of drilling
G17	X-Y plane	Z axis
G18	Z-X plane	Y axis
G19	Y-Z plane	X axis

Return to R point:

When tool perform to the bottom of the hole, the tool can return to initial position or R point. And that is decided by G98/G99, G98 is back to initial position, G99 is back to R point.

Number of repeats K:

If we want to perform many holes in the same distance, we can specify number of repeats K, range of K 0~9999, but the first hole need to use increment mode(G91) to specify, or it will repeat drilling in the same place.

When K=0, drilling data will be set, X, Y movement command cannot be executed in block, drilling cannot be execute too.

Cancel cycle:

G80 or G code of 01 group(G00/G01/G02/G03... etc.) can cancel cycle.

Increment (G91)/ absolute(G90) mode:

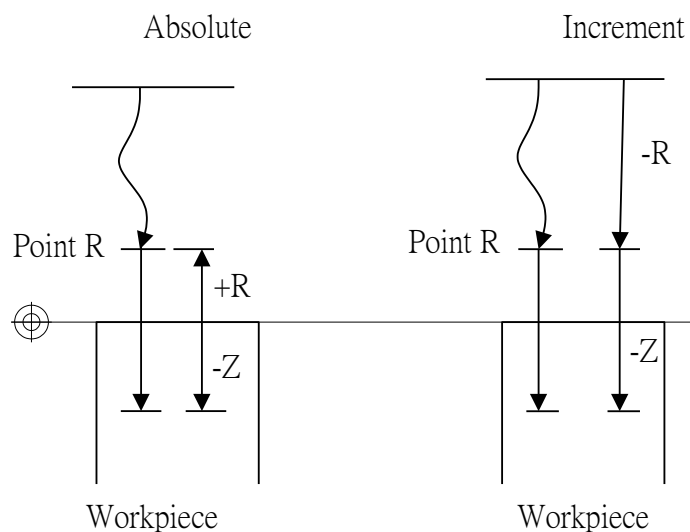

1.2.33 G73: HIGH SPEED PECK DRILL CYCLE

Command form:

G73 X__Y__Z__R__Q__F__K__ ;

X_or Y_: hole position data (absolute/increment)

Z_:

G91: the distance from the bottom of the hole to point Z (directional)

G90: program position of point Z

R_:

G91: the distance from initial level to R point level (directional)

G90: program position of point R

Q_: depth of cut for each cutting feed (increment and positive, minus will be ignore)

F_: feedrate

K_: number of repeats (movement of repeats and action of drilling, G91 increment effective)

X, Y, Z, R can use G90/G91 to decide absolute or increment

PIC:

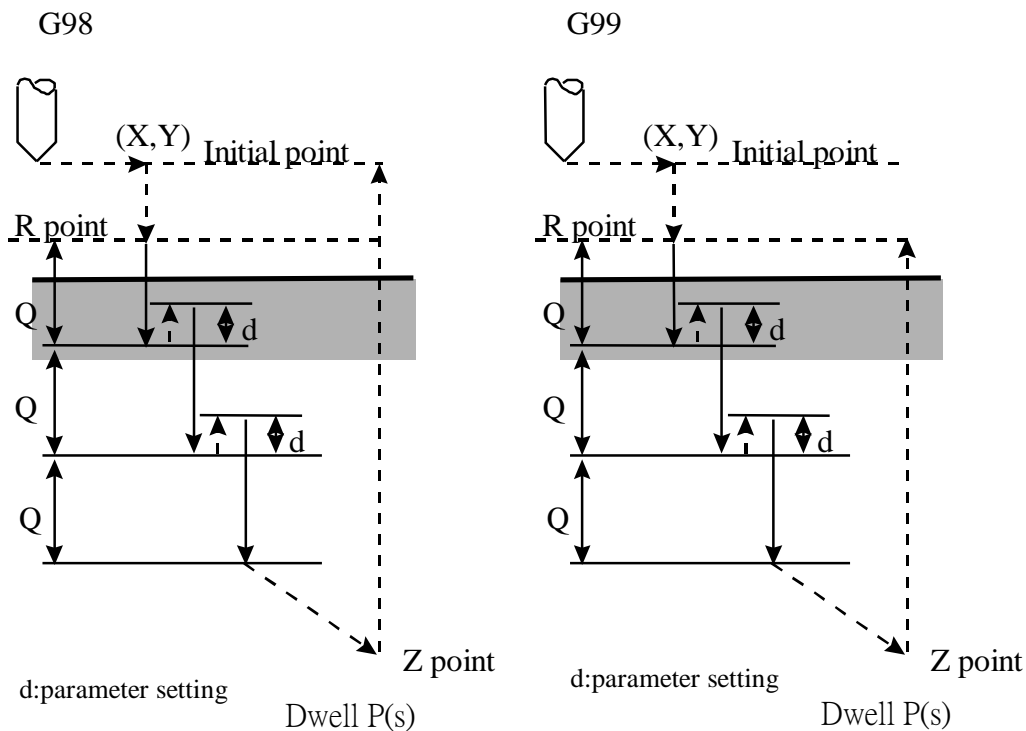

Description:

1. use G00 to move to specified (X,Y) when performance start
2. use G00 to reach specified R point.
3. use G01 to interpolate a distance Q at the present depth
4. use G00 to return a distance d (CNC parameter 4002)
5. repeat drilling hole until reach the Z point
6. use G00 to return initial point(G98) or programmable R point(G99)

Notes:

1. d distance is defined in CNC parameter No.4002.
2. before using G73, please use M Code let the drill start to turn.
3. if M Code and G73 are specified in the same block ,this M Code only executes in the first time of positioning in that block, when K is used to specify numbers of times, this M Code is executed for the first only, for the second hole and subsequent holes, the M Code is not executed.
4. G73 is module G Code , when use G73 once ,it is effectively always ,we only give the (X,Y) in the next line of program ,then controller will start to drill of (X,Y).
5. this module G code ,use G80 to cancel ,or G00 ,G01,G02,G03 or other cycle this G code will be canceled automatically.

Condition:

1. Before drilling axis be changed, Canned Cycle must be canceled first.
2. If a Block is not included movement command of any axes (X, Y, Z), then drilling can not be executed.
3. The data that Q and R specified, only be set in the block we execute drilling, it can not be set in the block we do not execute drilling.
4. G Code group 01 and G73 can not be specified in the same block, or G73 Canned Cycle will be cancel.
5. In Canned Cycle, tool length compensation (G41/G42/G40)will be ignored.

Program example:

```
F1000. S500;  
M03; // start the drill to turn CW  
G90;  
G00 X0. Y0. Z10.; // positioning to initial point  
G17;  
G90 G99;  
//set the R point, Z point and hole 1, cutting rate 2.0  
G73 X5. Y5. Z-10. R-5. Q2.;  
X15.; // hole 2  
Y15.; // hole 3  
G98 X5.; // hole 4, and return to initial point  
X10. Y10. Z-20.; // hole 5, and set new Z point be -20  
G80;  
M05; // stop drill  
M02;
```

1.2.34 G74: LEFT HAND TAPPING CYCLE

Command form:

G74 X__Y__Z__R__P__F__K__ ;

X_ or Y_: coordinates of holes (absolute/increment)

Z_:

G91: the distance from the bottom of the hole to point Z (directional)

G90: program position of point Z

R_:

G91: the distance from initial level to R point level (directional)

G90: program position of point R

P_: dwell time (s)

F_: feedrate

K_: number of repeats (repeat movement and drilling, G91 is effective)

X, Y, Z, R: use G90/91 to decide absolute or increment

PIC:

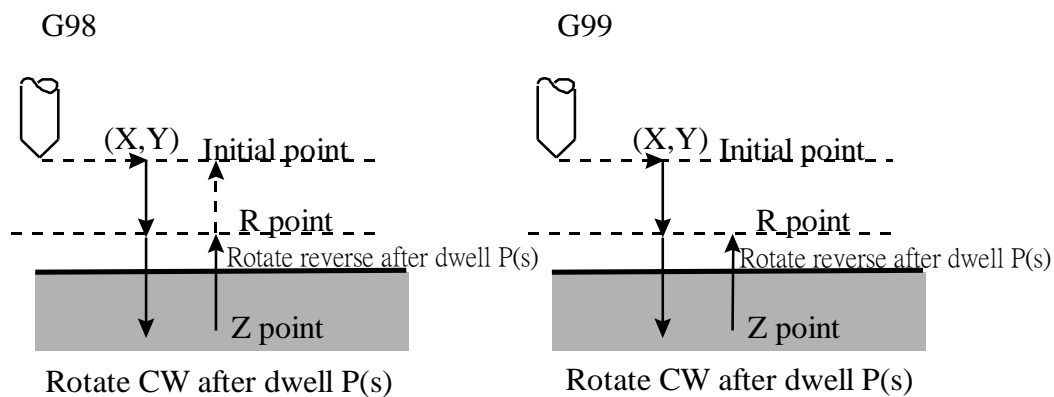

Description:

1. use G00 to move to specified(X,Y) when start to perform
2. use G00 to specified point R.
3. use G01 to reach the bottom of the hole ,point Z
4. dwell P(s) then reverse the drill
5. use G01 raise to point R
6. dwell P(s) then reverse the drill
7. use G00 to raise to initial point (G98) or programmable point R(G99)

tapping pitch / feed rate reduce:

- G94: $F \text{ (mm/min)} = S \text{ (RPM)} * P \text{ (mm/rev)}$
- G95: $F \text{ (mm/rev)} = P \text{ (mm/rev)}$
- G74: when performing, feedrate(F), spindle RPM(S), they are not controlled by turning switch(fixed at 100%)

Notes:

1. before G74, use M Code let drill start to rotate CCW
2. if M Code and G74 are specified in the same block ,this M Code only executes in the first time of positioning in that block
3. when K is used to specify numbers of times, this M Code is executed for the first only, for the second hole and subsequent holes, the M Code is not executed. G74 is module G Code ,it is always effective when we use once ,we only specify (X,Y) in next line of program ,controller will execute drilling at (X,Y)
4. this module G code ,use G80 to cancel ,when program run into G00 , G01, G02 , G03 or other cycle ,this module G code will be canceled automatically,
5. because there is a little time when spindle CW to CCW in tapping ,please use P add dwell in G code

Condition:

1. before drilling axis be changed, Canned Cycle must be canceled first.
2. if the Block does not include movement command of any axes (X, Y, Z), then drilling will not be executed.
3. data that R specified only be set in blocks of executing drilling, it can not be set in blocks of no executing drilling.
4. G code 01 group and G74 can be specified in the same block, or G74 Canned Cycle will be canceled.
5. in Canned Cycle, tool length compensation(G41/G42/G40) will be ignored.

Program example:

```
F1000. S500;  
G90;  
G00 X0. Y0. Z10.; // positioning to initial point  
G17;  
M04; // start drill to rotate CCW  
G90 G99;  
//specify point R 、 point Z and hole 1 coordinate values, dwell 2 s  
G74 X5. Y5. Z-10. R-5. P2.;
```

X15.; // hole 2
Y15.; // hole 3
G98 X5.; // hole 4, and set to return to initial point
X10. Y10. Z-20.; // hole 5, and set new point Z to be -20.
G80;
M05; // drill stops
M02;

1.2.35 G76: FINE BORING CYCLE

Command form:

G76 X__Y__Z__R__Q__P__F__K__ ;

X_ or Y_: hole position data (absolute/increment position)

Z_:

G91: the distance from the bottom of the hole to point Z (directional)

G90: program position of point Z

R_:

G91: the distance from initial level to R point level (directional)

G90: program position of point R

Q_: shift amount at the bottom of the hole (positive, negative will be ignored)

P_: dwell time at the bottom of the hole (s)

F_: feedrate

K_: number of repeats (repeat moving and drilling ,G91 is effective)

X, Y, Z, R is absolute or increment mode, decided by G90/G91

PIC:

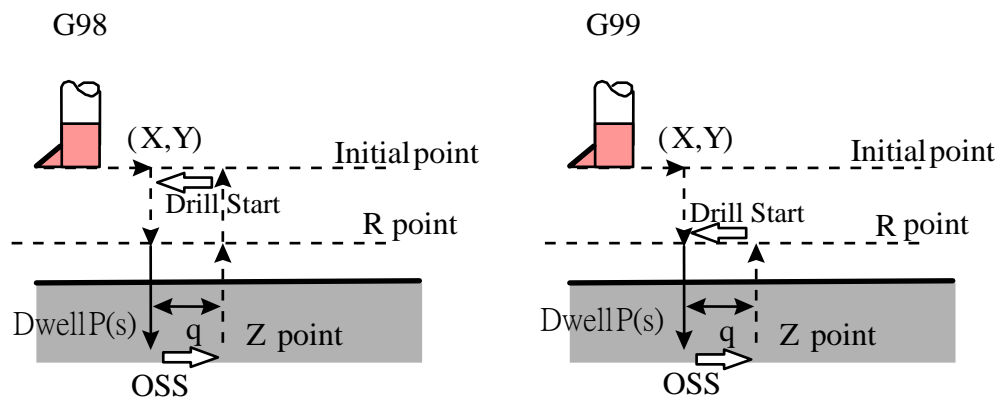

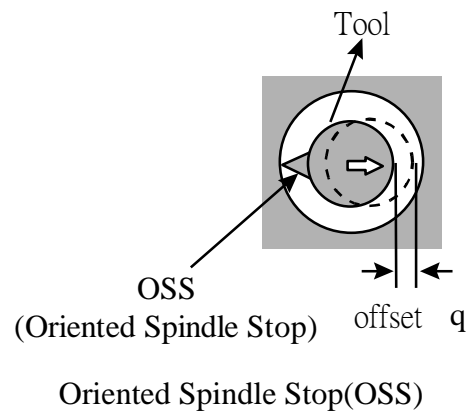

Description:

1. use G00 to move tool to specified (X, Y) point, when performance start
2. use G00 reach the specified R point(not include spindle positioning)
3. use G01 reach point Z at the bottom of the hole, dwell P(s) and spindle positioning and stop the drill
4. shift Q distance
5. use G00 raise to initial point (G98) or programmable point R (G99)
6. shift Q distance in reverse direction
7. drill start

※ alarm:

- Q is a Modal Value that requests in G76 cycle, we must specify this Q value carefully, because it also use in G73/G83.
- OSS(Oriented Spindle Stop) direction is decided by parameter No. 4020:

Parameter	OSS direction
0	+X
1	-X
2	+Y
3	-Y

Note:

1. before G76, use M Code let drill start to rotate CW.
2. if M Code and G76 are specified in the same block ,this M Code only executes in the first time of positioning in that block
3. when K is used to specify numbers of times, this M Code is executed for the first only, for the second hole and subsequent holes, the M Code is not executed.
4. G76 is module G Code ,it is always effective when we use once ,we only specify (X,Y) in next line of program ,controller will execute drilling at (X,Y)

5. this module G code ,use G80 to cancel ,when program run into G00, G01, G02 , G03 or other cycle ,this module G code will be canceled automatically.

Condition:

1. before drilling axis be changed, Canned Cycle must be canceled first.
2. if the Block does not include movement command of any axes (X, Y, Z), then drilling will not be executed.
3. Q must be specified a positive value. If Q is negative value ,it will be thought to be a positive value (absolute value), data that Q and R specified only be set in drilling blocks, it will not be set in not drilling blocks.
4. G Code group 01 and G76 can not be specified in the same block, or G76 Canned Cycle cancel.
5. in Canned Cycle, tool length compensation (G41/G42/G40)will be ignore.

Program example:

```
F1000. S500;  
M03; // start drill rotate CW  
G90;  
G00 X0. Y0. Z10.; // position to initial point  
G17;  
G90 G99;  
//specify point R 、 point Z and hole 1, shift amount at bottom of hole2.0,  
dwell time 5 s  
G76 X5. Y5. Z-10. R-5. Q2. P5.;  
X15.; // hole 2  
Y15.; // hole 3  
G98 X5.; // hole 4, and return to initial point  
X10. Y10. Z-20.; // hole 5, and specify the new point Z to be -20.0  
G80;  
M05; // drill stops  
M02;
```

1.2.36 G81: DRILLING CYCLE

Command form:

G81 X__Y__Z__R__F__K__ ;

X_ or Y_: hole position data (absolute/increment position)

Z_:

G91: the distance from the bottom of the hole to point Z (directional)

G90: program position of point Z

R_:

G91: the distance from initial level to R point level (directional)

G90: program position of point R

F_: feed rate

K_: number of repeats (repeat moving and drilling, G91 is effective)

X, Y, Z, R is absolute or increment mode, decided by G90/G91

PIC:

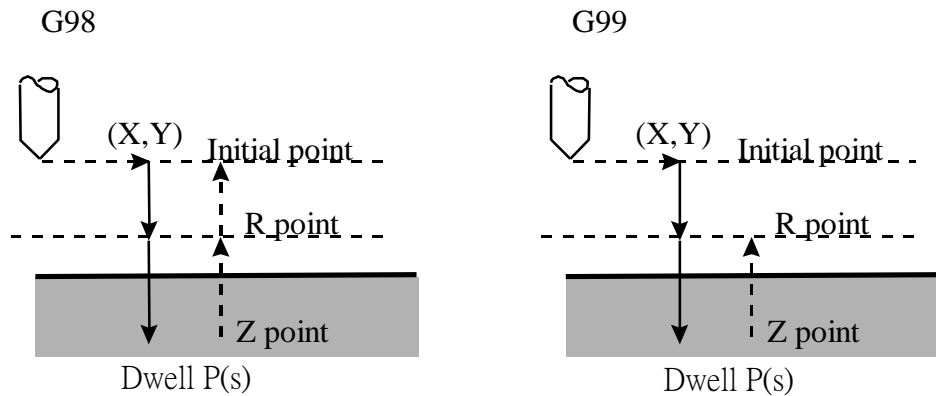

Description:

1. use G00 to positioning to specified (X,Y) when start to perform
2. use G00 to reach specified point R.
3. use G01 to reach point Z the bottom of the hole
4. use G00 to raise to initial point(G98) or program point R(G99)

Note:

1. before G81, use M Code to let drill start to rotate.
2. if M Code and G81 are specified in the same block ,this M Code only executes in the first time of positioning in that block,
3. when K is used to specify numbers of times, this M Code is executed for the first only, for the second hole and subsequent holes, the M Code is not executed.

Condition:

1. before drilling axis be changed, Canned Cycle must be canceled first.
2. if the Block does not include movement command of any axes (X, Y, Z), then drilling will not be executed.
3. data R specified only be set in drilling block, it will not be set in not drilling block.
4. G Code group 01 and G81 can not be specified in the same block, or G76 Canned Cycle cancel.
5. in Canned Cycle, tool length compensation (G41/G42/G40)will be ignore.

Program example:

```
F1000. S500;  
G90;  
G00 X0. Y0. Z10.; // positioning to initial point  
G17;  
G90 G99; //setting point R 、 point Z and hole 1  
G81 X5. Y5. Z-10. R-5.;  
X15.; // hole 2  
Y15.; // hole 3  
G98 X5.; // hole 4, and return to initial point  
X10. Y10. Z-20.; // hole 5, and set new point Z to be -20  
G80;  
M02;
```

1.2.37 G82: DRILLING CYCLE OF DWELL ON THE HOLE BOTTOM

Command form:

G82 X__Y__Z__R__P__F__K__ ;

X_ or Y_: hole position data (absolute/increment mode)

Z_:

G91: the distance from the bottom of the hole to point Z (directional)

G90: program position of point Z

R_:

G91: the distance from initial level to R point level (directional)

G90: program position of point R

P_: dwell time at the bottom of the hole (s)

F_: feed rate

K_: number of repeats (repeat moving and drilling, G91 is effective)

X, Y, Z, R is absolute or increment mode, decided by G90/G91

PIC:

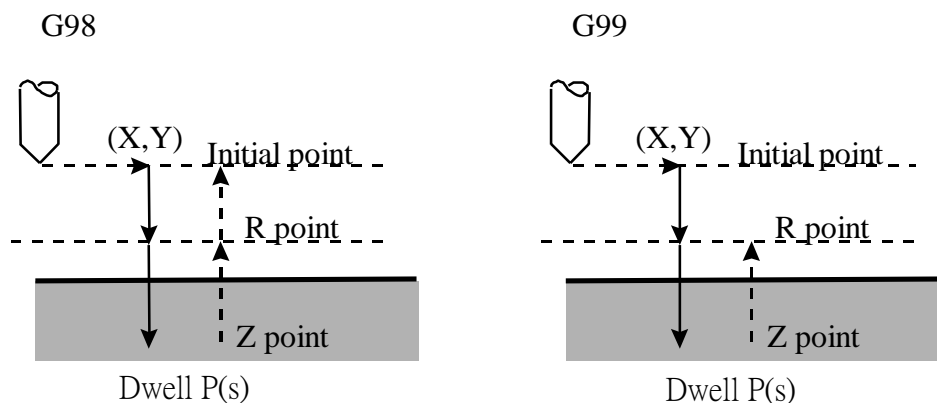

Description:

1. use G00 to positioning to specified (X,Y) when start to perform
2. use G00 to reach specified point R.
3. use G01 to reach point Z the bottom of the hole
4. dwell P (s)
5. use G00 raise to initial point(G98) or program point R(G99)

Notes:

1. before G82, use M Code to let drill start to rotate.
2. if M Code and G82 are specified in the same block ,this M Code only executes in the first time of positioning in that block
3. when K is used to specify numbers of times, this M Code is executed for the first only, for the second hole and subsequent holes, the M Code is not executed

Condition:

1. before drilling axis changes, Canned Cycle must be canceled first.
2. if the Block does not include movement command of any axes (X, Y, Z), then drilling will not be executed.
3. data R specified only be set in drilling block, it will not be set in not drilling block.
4. G Code group 01 and G82 can not be specified in the same block, or G76 Canned Cycle cancel.
5. in Canned Cycle, tool length compensation mode(G41/G42/G40) will be ignored.

Program example:

```
F1000. S500;  
G90;  
G00 X0. Y0. Z10.; // positioning to initial point  
G17;  
M03; // start drill to rotate CW  
G90 G99;  
//specified point R 、 point Z and hole 1, dwell time 2 s  
G82 X5. Y5. Z-10. R-5. P2.;  
X15.; // hole2  
Y15.; // hole3  
G98 X5.; // hole4, and return to initial point  
G80;  
M05; // drill stops  
M02;
```

1.2.38 G83: PECK DRILL CYCLE

Command form:

G83 X__Y__Z__R__Q__F__K__ ;

X_ or Y_: hole position data (absolute/increment mode)

Z_:

G91: the distance from the bottom of the hole to point Z (directional)

G90: program position of point Z

R_:

G91: the distance from initial level to R point level (directional)

G90: program position of point R

Q_: the feed depth (increment and positive value; negative value is neglected)

P_: dwell time at the bottom of the hole(s)

F_: feed rate

K_: number of repeats (repeat moving and drilling, G91 is effective)

X, Y, Z, R is absolute or increment mode, decided by G90/G91

PIC:

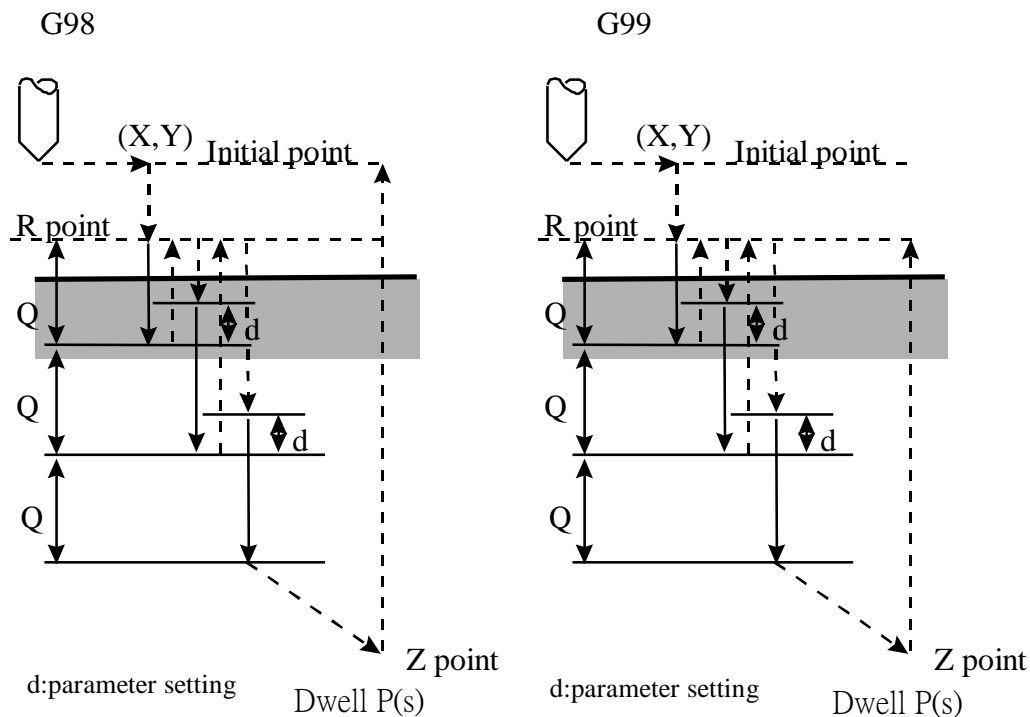

Description:

1. use G00 to positioning to specified (X,Y) when start to perform
2. use G00 to reach specified point R.
3. use G01 to interpolate a distance Q at the present depth
4. use G00 raise to point R of workpiece interface.
5. use G00 reach a distance “d” that opposite to the present depth(parameter 4002)
6. use G01 to interpolate a distance Q at the present depth
7. use G00 raise to point R of workpiece interface.
8. repeat performing until the bottom of the hole point Z
9. use G00 raise to initial point (G98) or program point R(G99)

Notes:

1. peck drill of returning tool value “d” ,it is specified by CNC parameter No.4002.
2. before using G83, use M Code let the drill to rotate first.
3. if M Code and G83 are specified in the same block ,this M Code only executes in the first time of positioning in that block
4. when K is used to specify numbers of times, this M Code is executed for the first only, for the second hole and subsequent holes, the M Code is not executed.

Condition:

1. before drilling axis changes, Canned Cycle must be canceled first.
2. if the Block does not include movement command of any axes (X, Y, Z), then drilling will not be executed
3. data Q and data R specified only be set in drilling block, it will not be set in not drilling block.
4. G Code group 01 and G83 can not be specified in the same block, or G76 Canned Cycle cancel.
5. in Canned Cycle, tool length compensation mode (G41/G42/G40) will be ignored.

Program example:

```
F1000. S500;  
M03; // start drill to rotate CW  
G90;  
G00 X0. Y0. Z10.; // positioning to initial point  
G17;
```

```
G90 G99; // specify point R, point Z and hole 1, cutting federate 3.0
G83 X5. Y5. Z-10. R-5. Q3.;
X15.; // hole2
Y15.; // hole3
G98 X5.; // hole4, and return to initial point
G80;
M05; // drill stops
M02;
```

1.2.39 G84: TAPPING DRILLING CYCLE

Command form:

G84 X__Y__Z__R__P__Q__F__K__ ;

X_ or Y_: hole position data (absolute/increment mode)

Z_:

G91: the distance from the bottom of the hole to point Z (directional)

G90: program position of point Z

R_:

G91: the distance from initial level to R point level (directional)

G90: program position of point R

P_: dwell time at the bottom of the hole(s)

Q_: the feed depth (increment and positive value; negative value is neglected)

F_: feed rate

K_: number of repeats (repeat moving and drilling, G91 is effective)

X, Y, Z, R is absolute or increment mode, decided by G90/G91.

PIC:

Type I: None argument Q

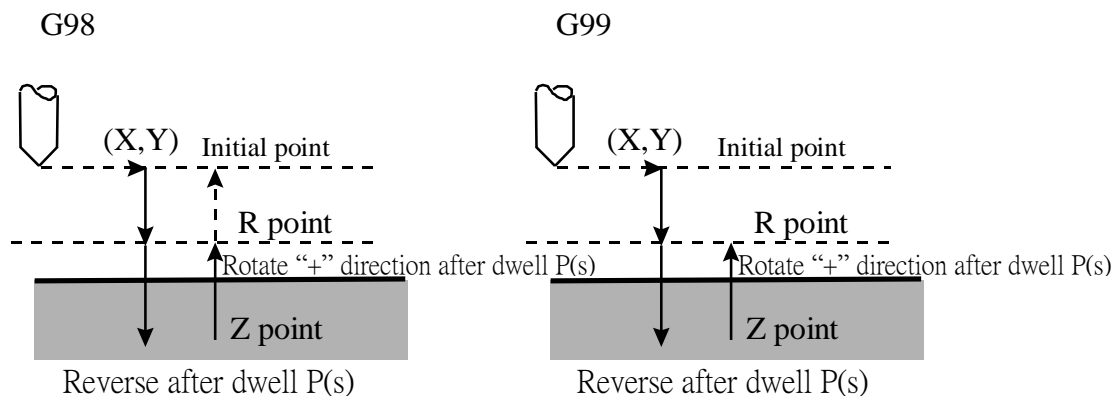

Description:

1. use G00 to positioning to specified (X,Y) when start to perform
2. use G00 to reach specified point R
3. use G01 to reach point Z the bottom of the hole
4. dwell P(s) and reverse the drill
5. use G01 to raise to point R
6. dwell P(s) and reverse the drill

7. use G00 to raise to initial point(G98) or program point R(G99)

TYPE II : High Speed Peck Tapping (Custom Parameter No.4001= 1)

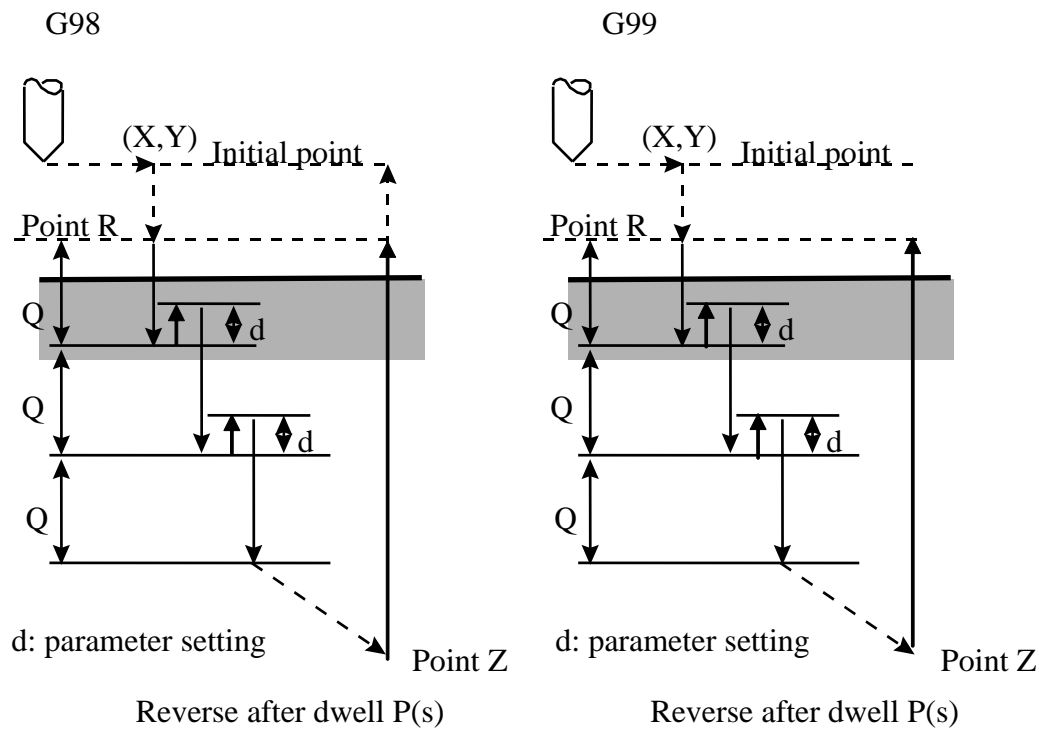

Description:

1. use G00 to positioning to specified (X,Y) when start to perform
2. use G00 to reach specified point R
3. use G01 to interpolate a distance Q at the present depth
4. After dwell P(s), use G01 to reach a distance “d” that opposite to the present depth (set by parameter 4002).
5. After dwell P(s), use G01 to interpolate a distance Q at the present depth.
6. After dwell P(s), use G01 to reach a distance “d” that opposite to the present depth (set by parameter 4002).
7. Repeat the above action until reaching the bottom of the hole, point Z.
8. Dwell P(s) and reverse the tap. Then use G01 to rise to point R (G99).
9. Dwell P(s) and reverse the tap. Then G00 to rise to initial point (G98).

TYPE III: General Peck Tapping (Custom Parameter No.4001= 0)

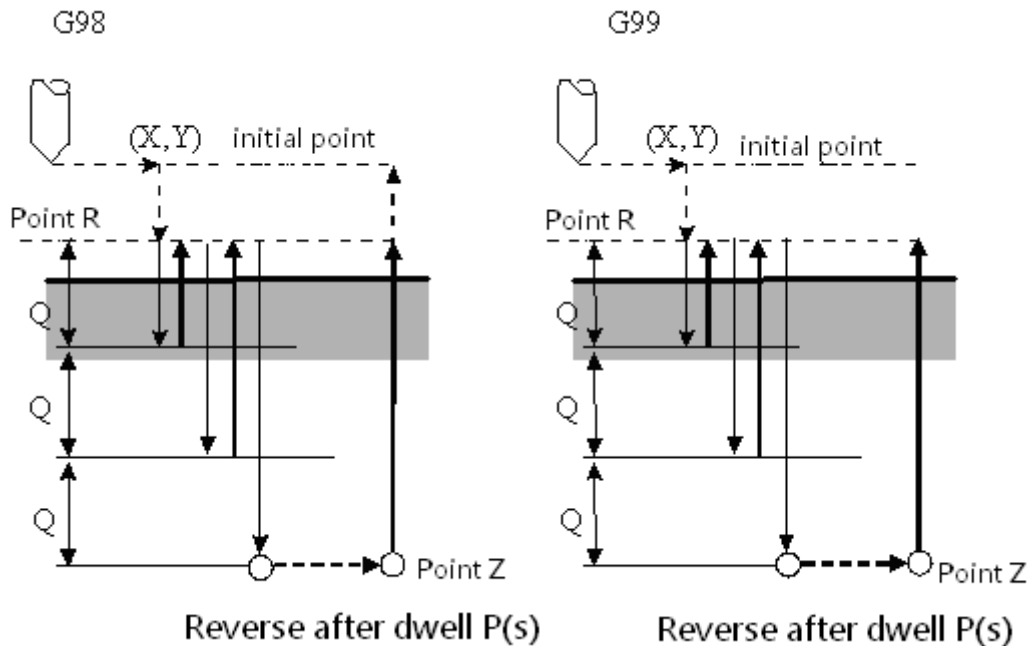

Description:

1. Use G00 to positioning to specified (X, Y) when start to perform.
2. Use G00 to reach specified point R.
3. Use G01 to interpolate a distance Q at the present depth.
4. Dwell P(s) and reverse the tap. Then use G01 to reach point R.
5. Dwell P(s) and reverse the tap. Then use G01 to interpolate a distance “Q” relative to the depth of present hole.
6. Dwell P(s) and reverse the tap. Then use G01 to reach point R.
7. Repeat the above action until reaching the bottom of the hole, point Z.
8. Dwell P(s) and reverse the tap. Then use G01 to rise to point R (G99).
9. Dwell P(s) and reverse the tap. Then use G00 to rise to initial point (G98).

tapping pitch/perform speed, reduce :

- G94: perform speed(F mm/min) =spindle rotate rate(S RPM) * pitch(P mm/rev)
- G95: perform speed(F mm/rev) = pitch(P mm/rev)
- G84: when performing, perform speed(F) spindle rotate rate(S), they are not controlled by turning switch(fix 100%)

Notes:

1. before using G84, use M Code to let the drill rotate CCW
2. if M Code and G84 are specified in the same block ,this M Code only executes in the first time of positioning in that block
3. when the K is used to specify numbers of repeats, this M Code is executed in the first hole only. G84 is module G Code ,it is always effective when we use once ,we only specify (X,Y) in next line of program ,controller will execute drilling at (X,Y)
4. this module G Code ,will be canceled when G80 command ,or we command G00 ,G01,G02,G03 or other cycle G code ,this module G code will be canceled automatically
5. because there is a period of time that spindle from CW to CCW at tapping , please command P to dwell a period of time

Condition:

1. before drilling axis changes, Canned Cycle must be canceled first.
2. if the Block does not include movement command of any axes (X, Y, Z), then drilling will not be executed.
3. data R specified only be set in drilling block, it will not be set in not drilling block.
4. G Code group 01 and G84 can not be specified in the same block, or G76 Canned Cycle cancel.
5. in Canned Cycle, tool length compensation mode (G41/G42/G40) will be ignored.

Program example:

```
F1000. S500;  
G90;  
G00 X0. Y0. Z10.; // positioning to initial point  
G17;  
M03; // start drill to rotate CW  
G90 G99;  
//specify point R 、 point Z and hole1  
G84 X5. Y5. Z-10. R-5.;  
X15.; // hole2  
Y15.; // hole3  
G98 X5.; // hole4, and return to initial point  
G80;
```

M05; // drill stops

M02;

1.2.40 G85: DRILLING CYCLE

Command form:

G85 X__Y__Z__R__F__K__ ;

X_ or Y_: hole position data (absolute/increment mode)

Z_:

G91: the distance from the bottom of the hole to point Z (directional)

G90: program position of point Z

R_:

G91: the distance from initial level to R point level (directional)

G90: program position of point R

P_: dwell time at the bottom of the hole(s)

F_: feed rate

K_: number of repeats (repeat moving and drilling, G91 is effective)

X, Y, Z, R is absolute or increment mode, decided by G90/G91.

PIC:

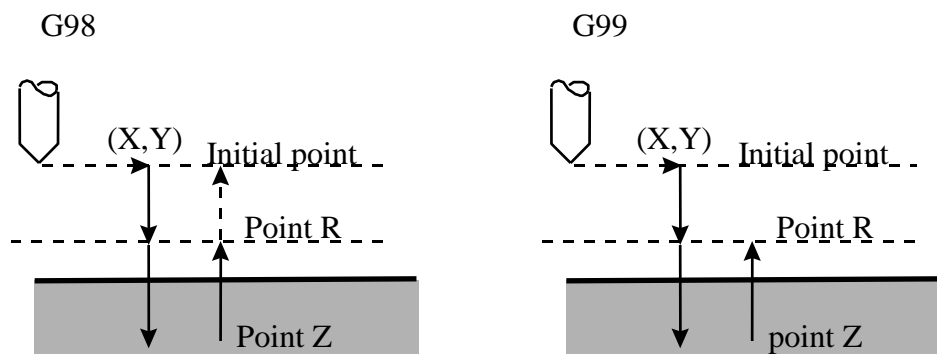

Description:

1. use G00 to positioning to specified (X,Y) when start to perform
2. use G00 to reach specified point R.
3. use G01 to reach point Z the bottom of the hole,
4. G01 command to raise to point R
5. G00 command to raise to initial point(G98) or program point R(G99)

Notes:

1. before G85 command, use M Code to let the spindle rotate.

2. if M Code and G85 are specified in the same block ,this M Code only executes in the first time of positioning in that block.
3. when K is used to specify numbers of times, this M Code is executed for the first only, for the second hole and subsequent holes, the M Code is not executed.

Condition:

1. before drilling axis changes, Canned Cycle must be canceled first.
2. if the Block does not include movement command of any axes (X, Y, Z), then drilling will not be executed.
3. data R specified only be set in drilling block, it will not be set in not drilling block.
4. G Code group 01 and G85 can not be specified in the same block, or G76 Canned Cycle cancel.
5. in Canned Cycle, tool length compensation mode (G41/G42/G40) will be ignored.

Program example:

```
F1000. S500;  
G90;  
G00 X0. Y0. Z10.; // positioning to initial point  
G17;  
M03; // start drill to rotate CW  
G90 G99;  
//specify point R 、 point Z and hole 1  
G85 X5. Y5. Z-10. R-5.;  
X15.; // hole2  
Y15.; // hole3  
G98 X5.; // hole4, and return to initial point  
G80;  
M05; // drill stops  
M02;
```

1.2.41 G86: HIGH SPEED DRILLING CYCLE

Command form:

G86 X__Y__Z__R__F__K__ ;

X_or Y_: hole position data (absolute/increment mode)

Z_:

G91: the distance from the bottom of the hole to point Z (directional)

G90: program position of point Z

R_:

G91: the distance from initial level to R point level (directional)

G90: program position of point R

P_: dwell time at the bottom of the hole (s)

F_: feed rate

K_: number of repeats (repeat moving and drilling, G91 is effective)

X, Y, Z, R is absolute or increment mode, decided by G90/G91

PIC:

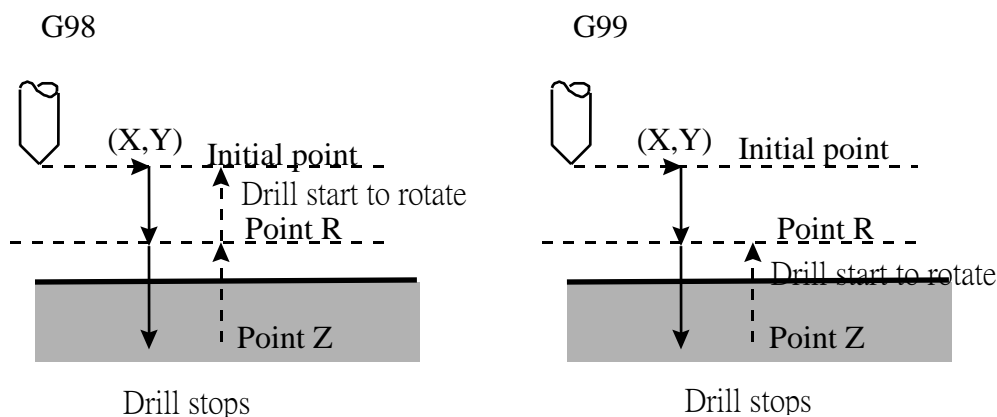

Description:

1. use G00 to positioning to specified (X,Y) when start to perform
2. use G00 to reach specified point R.
3. use G01 to reach point Z the bottom of the hole,
4. use G00 to raise to initial point (G98) or program point R(G99)

Notes:

1. before using G86, use M Code to let the drill to rotate.
2. if M Code and G86 are specified in the same block ,this M Code only executes in the first time of positioning in that block

3. when K is used to specify numbers of times, this M Code is executed for the first only, for the second hole and subsequent holes, the M Code is not executed.

Condition:

1. before drilling axis changes, Canned Cycle must be canceled first.
2. if the Block does not include movement command of any axes (X, Y, Z), then drilling will not be executed.
3. data R specified only be set in drilling block, it will not be set in not drilling block.
4. G Code group 01 and G86 can not be specified in the same block, or G76 Canned Cycle cancel.
5. in Canned Cycle, tool length compensation mode (G41/G42/G40) will be ignored.

Program example:

```
F1000. S500;  
G90;  
G00 X0. Y0. Z10.; // positioning to initial point  
G17;  
M03; // start drill to rotate CW  
G90 G99;  
//specify point R 、 point Z and hole 1  
G86 X5. Y5. Z-10. R-5.;  
X15.; // hole2  
Y15.; // hole3  
G98 X5.; // hole4, and return to initial point  
G80;  
M05; // drill stops  
M02;
```

1.2.42 G87: FINE BORING CYCLE OF BACK SIDE

Command form:

G87 X__Y__Z__R__Q__P__F__K__ ;

X_ or Y_: hole position data (absolute/increment position)

Z_:

G91: the distance from the bottom of the hole to point Z (directional)

G90: program position of point Z

R_:

G91: the distance from initial level to R point level (directional)

G90: program position of point R

Q_: shift amount at the bottom of the hole (positive, negative will be ignored)

P_: dwell time at the bottom of the hole (s)

F_: feedrate

K_: number of repeats (repeat moving and drilling, G91 is effective)

X, Y, Z, R is absolute or increment mode, decided by G90/G91

PIC:

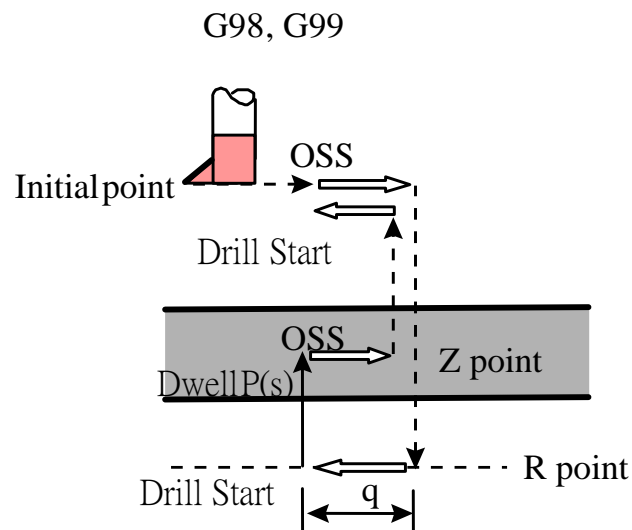

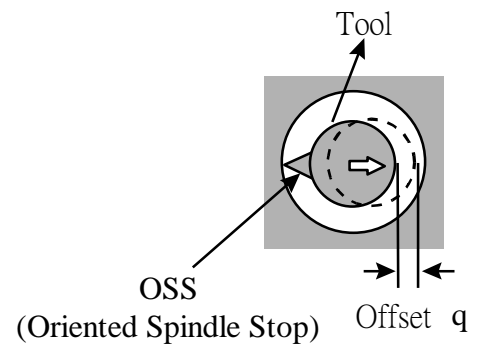

Oriented Spindle Stop(OSS) PIC

Description:

1. use G00 to positioning to specified (X,Y) when start to perform
2. after OSS stops ,use the direction that parameter 4020 specify ,and shift amount a Q distance in reverse direction
3. use G00 to reach specified point R, shift amount a Q distance,
4. drill rotate CW.
5. G01 command to raise to point Z
6. after dwell P(s) and shift amount a Q distance in reverse direction
7. G00 command to raise to initial point
8. after drill start and shift amount a Q distance.

※Alarm:

- Q is a Modal Value that request in G87 cycle. This Q value must be specified carefully because it is also used in G73/G83 cycle.
- OSS(Oriented Spindle Stop) direction is decided by parameter No. 4020:

Parameter 4020	OSS direction
0	+X
1	-X
2	+Y
3	-Y
4	+Z
5	-Z

Notes:

1. before G87 command, use M Code to let the spindle rotate.
2. if M Code and G87 are specified in the same block , this M Code only executes in the first time of positioning in that block
3. when K is used to specify numbers of times, this M Code is executed for the first only, for the second hole and subsequent holes, the M Code is not executed.

Condition:

1. before drilling axis changes, Canned Cycle must be canceled first.
2. if the Block does not include movement command of any axes (X, Y, Z), then drilling will not be executed.

3. Q must be specified to a positive value. If Q were a negative value, it will be specified to positive value (absolute value), data Q and data R specified only be set in drilling block, it will not be set in not drilling block.
4. G Code group 01 and G87 can not be specified in the same block, or G76 Canned Cycle cancel.
5. in Canned Cycle, tool length compensation mode (G41/G42/G40) will be ignored.

Program example:

F1000. S500;

G90;

G00 X0. Y0. Z10.; // positioning to initial point

G17;

G90 G99;

M03; // start drill to rotate CW

//specify point R 、 point Z and hole 1, shift amount 5.0, dwell time 4.0s

G87 X5. Y5. Z10. R-30. Q5. P4.;

X15.; // hole2

Y15.; // hole3

G80;

M05; // drill stops

M02;

1.2.43 G88: FINE BORING CYCLE OF HALF

AUTOMATION

Command form:

G88 X__Y__Z__R__P__F__K__ ;

X_ or Y_: hole position data (absolute/increment position)

Z_:

G91: the distance from the bottom of the hole to point Z (directional)

G90: program position of point Z

R_:

G91: the distance from initial level to R point level (directional)

G90: program position of point R

P_: dwell time at the bottom of the hole (s)

F_: feedrate

K_: number of repeats (repeat moving and drilling, G91 is effective)

X, Y, Z, R is absolute or increment mode, decided by G90/G91

PIC:

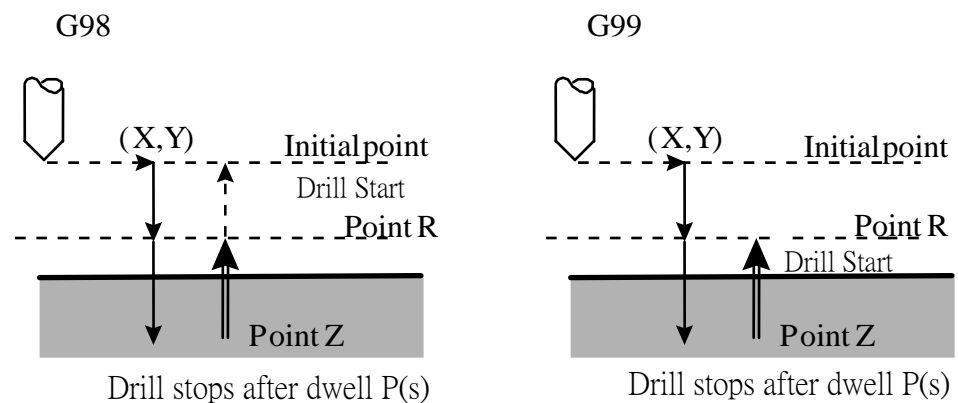

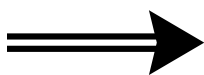
※  for positioning by manual.

Description:

1. use G00 to positioning to specified (X,Y) when start to perform
2. use G00 to reach specified point R.
3. use G01 to reach point Z the bottom of the hole,

4. drill stops after dwell P(s),
5. make the tool out of workpiece in manual mode and reset
6. use G01 to move to point R
7. use G00 to raise to initial point(G98) or program point R(G99)
8. drill rotate CW.

Notes:

1. before G88 command, use M Code to let drill start to rotate first.
2. if M Code and G88 specify in the same block ,this M Code only executes once when the first time positioning in that block
3. when K is used to specify numbers of times, this M Code is executed for the first only, for the second hole and subsequent holes, the M Code is not executed.

Condition:

1. before drilling axis changes, Canned Cycle must be canceled first.
2. if the Block does not include movement command of any axes (X, Y, Z), then drilling will not be executed.
3. data R specified only be set in drilling block, it will not be set in not drilling block.
4. G Code group 01 and G88 can not be specified in the same block, or G76 Canned Cycle cancel.
5. in Canned Cycle, tool length compensation mode (G41/G42/G40) will be ignored.

Program example:

```
F1000. S500;  
G90;  
G00 X0. Y0. Z10.; // positioning to initial point  
G17;  
M03; // start drill to rotate CW  
G90 G99;  
//specify point R 、 point Z and hole1, dwell 2.0s  
G88 X5. Y5. Z-10. R-5. P3.;  
X15.; // hole2  
Y15.; // hole3  
G98 X5.; // hole4, and return to initial point  
G80;  
M05; // drill stops  
M02;
```

1.2.44 G89: BORING CYCLE OF DWELL ON THE HOLE BOTTOM

Command form:

G89 X__Y__Z__R__P__F__K__;

X_ or Y_: hole position data (absolute/increment position)

Z_:

G91: the distance from the bottom of the hole to point Z (directional)

G90: program position of point Z

R_:

G91: the distance from initial level to R point level (directional)

G90: program position of point R

P_: dwell time at the bottom of the hole (s)

F_: feedrate

K_: number of repeats (repeat moving and drilling, G91 is effective)

X, Y, Z, R is absolute or increment mode, decided by G90/G91.

PIC:

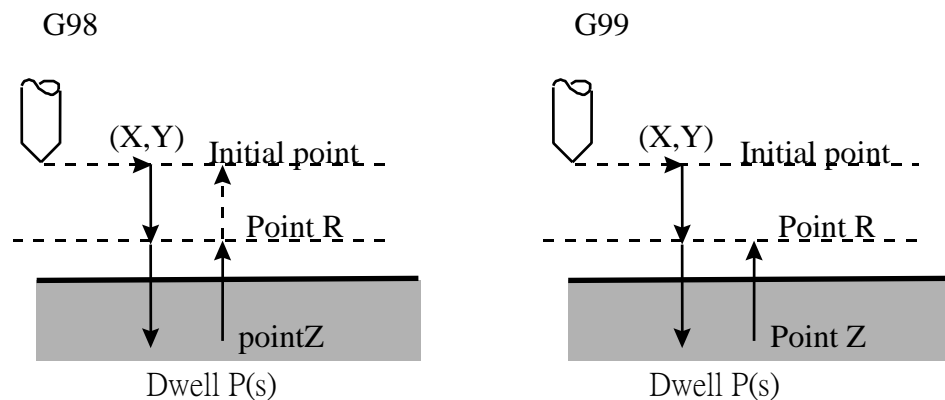

Description:

1. use G00 to positioning to specified (X,Y) when start to perform
2. use G00 to reach specified point R.
3. use G01 to reach point Z the bottom of the hole
4. dwell P (s)
5. use G01 to raise to point R
6. use G00 to raise to initial point (G98) or program point R(G99)

Notes:

1. before G89 command, use M Code to let the drill start to rotate.
2. if M Code and G89 are specified in the same block ,this M Code only executes in the first time of positioning in that block
3. when K is used to specify numbers of times, this M Code is executed for the first only, for the second hole and subsequent holes, the M Code is not executed.

Condition:

1. before drilling axis changes, Canned Cycle must be canceled first.
2. if the Block does not include movement command of any axes (X, Y, Z), then drilling will not be executed.
3. data R specified only be set in drilling block, it will not be set in not drilling block.
4. G Code group 01 and G89 can not be specified in the same block, or G76 Canned Cycle cancel.
5. in Canned Cycle, tool length compensation mode (G41/G42/G40) will be ignored.

Program example:

```
F1000. S500;  
G90;  
G00 X0. Y0. Z10.; // positioning to initial point  
G17;  
M03; // start drill to rotate CW  
G90 G99;  
//specify point R 、 point Z and hole1, dwell 2.5s  
G89 X5. Y5. Z-10. R-5. P2.5;  
X15.; // hole2  
Y15.; // hole3  
G98 X5.; // hole4, and return to initial point  
G80;  
M05; // drill stops  
M02;
```

1.2.45 G90/G91: ABSOLUTE/INCREMENT

COMMEND

Command form:

G90;

G91;

Description:

G90: absolute command.

G91: incremental command.

PIC:

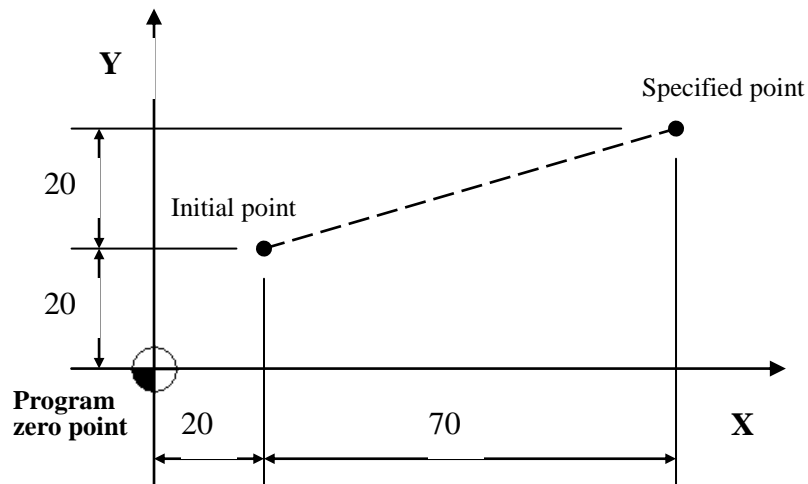

Description:

1. first way(absolute): G90 G00 X90.0 Y40.0 ;
//use the different distance from specified point to program zero point, to linear interpolation to specified point
2. second way(increment): G91 G00 X70.0 Y20.0 ;
//use the different distance from specified point to starting point, to linear interpolation to specified point

1.2.46 G92: SETTING OF WORK COORDINATE SYSTEM

SYSTEM

Command form:

G92 X__ Y__ Z__;

X、Y、Z: set the position that work coordinate system(G92) in programmable coordinate system

Description:

When we design the program, we must set another program coordinate zero point, we can use G92 to set a new coordinate system at this time, this command is set a new zero point of coordinate system when the tool is in any position, after setting tool will start to perform at this point, absolute command is computed by this new coordinate system.

PIC:

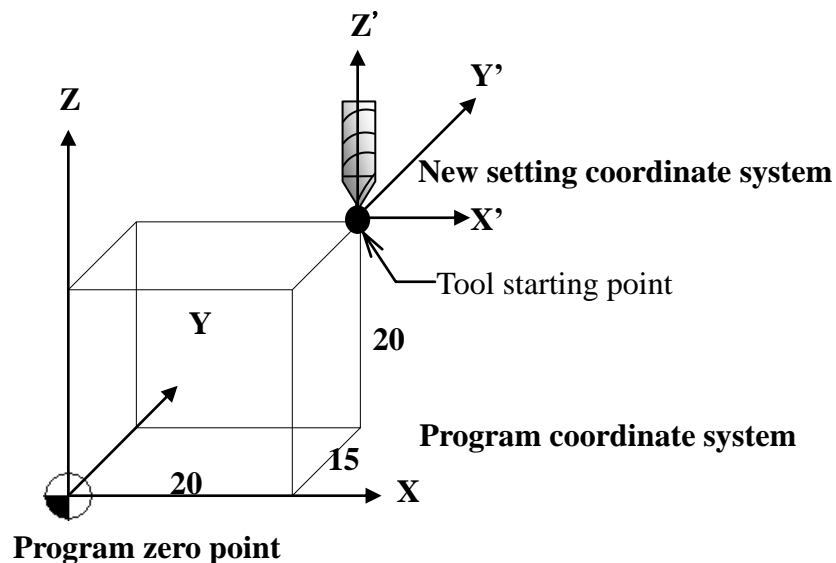

Format: G92 X20.0 Y15.0 Z20.0 ;

1.2.47 G94/G95: FEED UNIT SETTING

Command form:

G94 F__;

G95 F__;

Description: this command set the unit of feedrate of F__function (tool move distance per unit time or move distance per revolution) ; G94 is feed value per minute, unit: mm/min, inch/min, G95 is feed value per revolution, unit: mm/rev, inch/rev.

PIC:

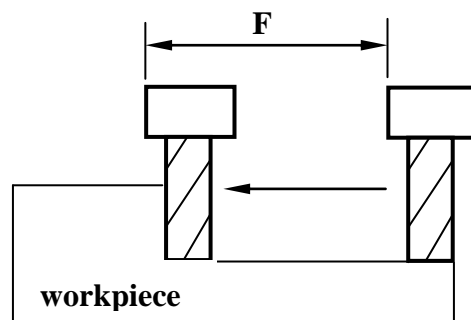

G94. feed per minute(mm/min or inch/min)

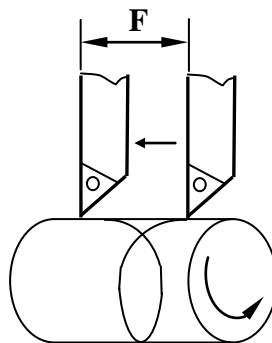

G95. feed per revolution(mm/rev or inch/rev)

1.2.48 G96/G97: CONSTANT LINEAR VELOCITY CONTROL ON SURFACE

Command form:

G96 S__ ; constant linear velocity control on surface: ON

G97 S__ ; constant linear velocity control on surface: OFF

Description:

G96 specify the surface speed (relative speed between the tool and workpiece), G97 command can cancel G96 command, it also can specify spindle speed ; in performance, use the tool in different radius, but we need surface speed in a fixed value, we can use G96 S__ to control surface speed ; if you do not mind how big is the diameter of tool when perform, and we fix the spindle speed, we can use G97 S__ to control spindle speed, follow the formula:

$$V = \frac{\pi DN}{1000}$$

V: surface speed, it can use G96 to specify to fixed value, unit M/MIN or FEET/MIN.

D: diameter of tool, unit mm

N: spindle speed, it can use G97 to specify to fixed value, unit RPM.

Example 1:

spindle surface speed fixed:

G92 S2000; //use G92 to restrict spindle max revolution

G96 S130 M03; //for interpolation speed is 130 m/min

Notes: G92 always used with G96, it restricts max revolution of spindle, example is tool NO.2 diameter 10mm, then:

$$N = \frac{1000 \times 130}{\pi \times 10} = 4140rpm$$

Through G92 the spindle max revolution is 2000rpm, in order to prevent spindle revolution too big centrifugal too big, workpiece is not tight with the machine, so some accident will happen ; so we use G92 to match

G96 in some times

Example 2:

spindle revolution fixed: G97 S1300 M03 ;

//for spindle keep 1300 rev/min

1.2.49 G134: CIRCUMFERENCE HOLE CYCLE

Command form:

G134 X__ Y__ I__ J__ K__ ;

X, Y: center position of circumference hole, effective by G90/G91.

I: radius of circle(r), unit is specified by G70/G71, must in positive value.

J: angle of initial drilling hole.

K: number of holes. Range 1~9999, can not be zero. It is specified positive when CCW, negative when CW.

Description:

Use the point between X axis and angle ,start to make the circle in n parts, n holes. The point is on the circle that center is specified (X,Y) and the radius is r.

Example:

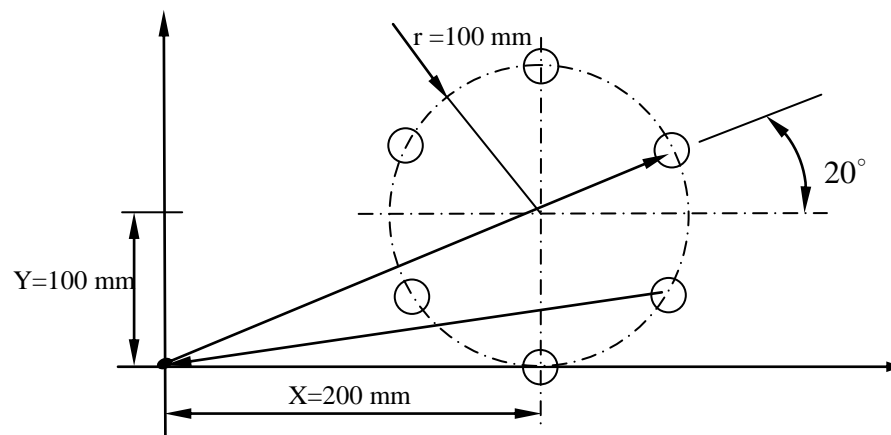

Program description:

G92 X500.0 Y100.0 ; //set absolute zero point coordinate system

G91 G81 Z-10.0 R5.0 K0 F200 ;

//execute drilling cycle, feedrate 200mm/min, depth 10 mm, and return to initial point when finish

G134 X200.0 Y100.0 I100.0 J20.0 K6 ;

//execute circumference hole cycle, X=200mm, Y=100mm drill the first hole, radius 100mm, starting angle 20° , 6 holes

G80 ; //cancel cycle

G90 G0 X0.0 Y0.0 ; //return to the system zero point

1.2.50 G135: ANGULAR STRAIGHT HOLE CYCLE

Command form:

G135 X__ Y__ I__ J__ K__ ;

X, Y: starting position, effective by G90/G91.

I: interval, unit is specified by G70/G71, if it is negative then use starting point to be the center and drill holes in symmetry direction.

J: angle of horizontal, CCW is positive.

K: number of holes, include starting point, range 1~9999.

Example:

Use the interval to drill n holes in the direction that X axis and a angle, the starting point is specified (X, Y)

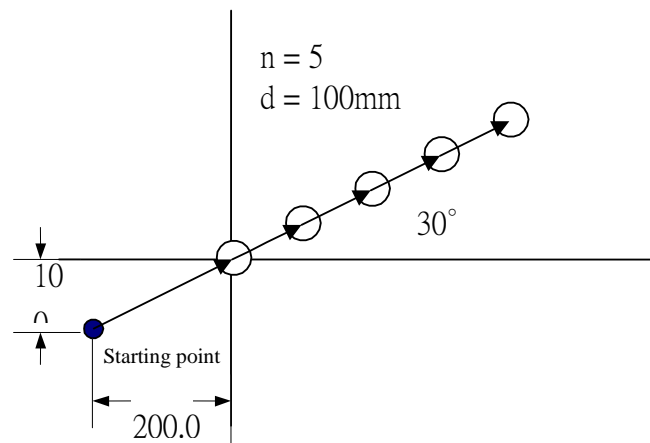

Program description:

G91 ; //use increment mode

G81 Z-10.0 R5.0 K0 F100 ;

//execute drill cycle, feedrate 100mm/min, depth of each hole 10 mm, return to starting point when finish

G135 X200.0 Y100.0 I100.0 J30.0 K5 ;

//execute angular straight hole cycle, X=200mm,Y=100mm be starting position, interval 100mm, angle with horizontal 30° , 5 holes

1.2.51 G136: ARC TYPE HOLE CYCLE

Command form:

G136 X__ Y__ I__ J__ P__ K__ ;

X, Y: center coordinate of arc, effective by G90/91.

I: radius of arc, unit is specified by G70/G71, present in positive value.

J: angle of the first drilling hole, positive in CCW.

P: interval of angle, positive in CCW.

K: number of holes.

Description:

Use the point make between X axis and a angle to be starting point ,and drill a hole every angular. The hole is drilling in the arc that specified (X,Y) is center and “r” is radius.

Example:

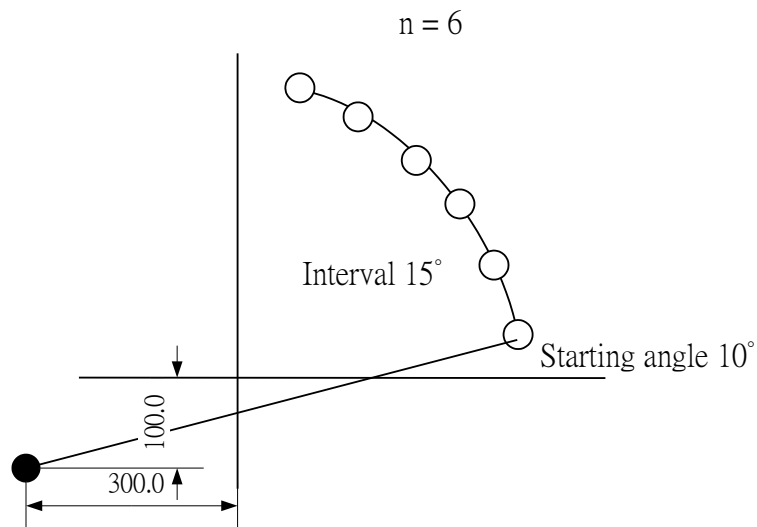

G91 ; //use incremental mode

G81 Z-10.0 R5.0 K0 F100 ;

//execute drilling cycle, cutting feedrate 100mm/min, depth of each holes 10 mm, and return the initial point

G136 X300.0 Y100.0 I300.0 J10.0 P15000 K6 ;

//execute arc type hole cycle, X=300mm,Y=100mm to be the center of the arc, radius 300mm, starting angle value10° , interval angle15° , 6 holes

1.2.52 G137.1: CHESS TYPE HOLE CYCLE

Command form:

G137.1 X__ Y__ I__ P__ J__ K__ ;

X, Y: coordinates of starting point, effective by G90/G91.

I: X axis interval, unit is decided by G70/G71, if the interval value is positive ,then go through positive direction from starting point, if it is negative ,then go through negative direction.

P: interval of X axis direction, range 1~9999.

J: interval of Y axis direction

K: number of Y axis direction, range 1~9999.

Description:

The starting point is specified (X,Y), we get the interval at horizontal direction of X axis, and drill nx chess type holes. We get the interval at horizontal direction of Y axis, and drill ny chess type holes.

Example:

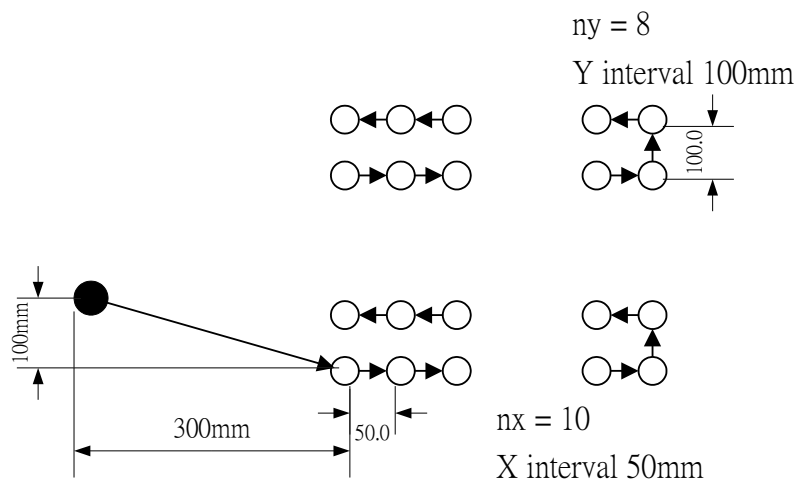

G91 ; //use incremental mode

G81 Z-10.0 R5.0 K0 F20 ;

//execute drilling cycle, cutting feedrate 20mm/min, depth of each hole 10 mm, then return to initial point

G137.1 X300.0 Y-100.0 I50.0 P10 J100.0 K8 ;

//execute chess type hole cycle, X = 300mm, Y = -100mm to be strating point, X axis interval is 50mm, number of the hole is 10, Y axis interval is 100mm, number of the hole is 8

1.2.53 Tool Function: T Code Command

Command form:

T__

Description:

Tool function is also called T function. It is used to choose the tools. We usually use it to change tool in conjunction with M06, we can auto do tool exchange according to the number of the tools.

Example:

T03 M06; //for change to tool No.3

1.2.54 Spindle Speed Function: S Code Command

Command form:

S __

Description:

S function is spindle speed command, specify spindle rev/min (RPM) or constant linear velocity, it is specified by G96/G97.

Example:

G96 S150 M03; //constant linear velocity on surface, 150 m/min

G97 S500 M03; //keep 500 rev/min

1.2.55 Cyclic Processing Function

G Code	Drilling Operation	Operation in the bottom of the hole	Retraction operation	Applications
G73	Intermittent feed	----	Rapid traverse	High speed peck drilling cycle
G74	Cutting feed	Spindle rotates in positive direction after dwelling	Cutting feed	Left hand tapping cycle
G76	Cutting feed	Spindle positioning stops and turns an angular displacement	Rapid traverse	Fine boring cycle

G80	----	----	----	Cancel Cycle
G81	Cutting feed	----	Rapid traverse	Drilling Cycle
G82	Cutting feed	Dwell	Rapid traverse	Drilling cycle dwell at bottom of hole
G83	Intermittent feed	----	Rapid traverse	peck drilling cycle
G84	Cutting feed	Spindle rotates in negative direction after dwelling	Cutting feed	Tapping Cycle
G85	Cutting feed	----	Cutting feed	Boring Cycle
G86	Cutting feed	Spindle stops	Rapid traverse	Boring Cycle
*G87	Cutting feed	Spindle rotates in positive direction	Rapid traverse	Fine boring cycle (side)
*G88	Cutting feed	Spindle stops after dwelling	Manual displacement	Fine boring cycle (Semi-auto)
G89	Cutting feed	Dwell	Cutting feed	Bottom hole dwell Boring cycle

Repeated Cycle Descriptions

	Description
G	Order selection in repeated cycles.
X	Specification of drilling point(absolute value or incremental value).
Y	Specification of drilling point(absolute value or incremental value).
Z	Specification of hole bottom(absolute value or incremental value).
P	Specification of dwell time at the bottom of the hole
Q	Depth of cut for each cutting feed in G73 and G83 / Specification of displacement in G76 and G87(incremental value)
R	Specification of R point position(absolute value or incremental value).
F	Specification of feedrate speed
K	Specification of repetition counts 0~999 in repeated cycles

Specification of drilling axis can be set by G17, G18, G19, as shown below :

G Code	Oriented plane	Drilling axis
G17	XY plane	Z axis
G18	ZX plane	Y axis
G19	YZ plane	X axis

Return to position R point

While processing to the bottom of the hole, tool escapes back to the initial level or point-R level. In returning, G98/G99 specifies whether the tool retract to initial level or point-R level. G98 is for returning to initial and G99 is for returning to point-R level.

Counts of repetition K

If several holes with the same distance are to be processed, specify the number of holes K ranging from 0 to 9999. The first hole position has to be set in incremental mode (G91), otherwise the machine will execute the repeated drilling at the same position.

When K=0, data of drilling motion will be set. But neither X,Y move instructions set in block nor drilling action will be execute.

Cycle cancel

G80 or G code group 01 can cancel cycle (G00/G01/G02/G03, etc...)

Incremental (G91) / Absolute (G90) Mode

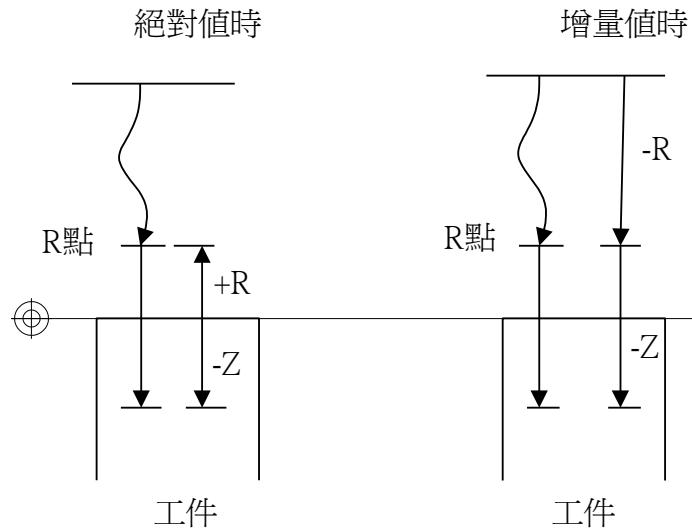

1.2.56 Feed Function: F Code Command

Command form:

F __

Description:

When interpolate workpiece, the only speed we specify to tool in the program, is called feedrate. There is two to specify the feedrate (G94/G95). If we use G94 , F300 is for 300 mm/min. If we use G95, F0.5 is for 0.5mm/rev.

Example:

G94 G01 X100.0 Y100.0 F300;

//linear interpolation, feedrate is 300mm/min

G95 G01 X100.0 Y100.0 F0.5;

//linear interpolation, feedrate is 0.5mm/rev

2 M Code Description:

Ancillary function is used to control machine function ON or OFF. The description is as below:

M function table

M Code	Function
M00	Program dwell
M01	Selectivity program dwell
M02	End program
M03	Spindle rotate(CW)
M04	Spindle rotate(CCW)
M05	Spindle stop
M06	Tool exchange
M08	Coolant liquid ON
M09	Coolant liquid OFF
M19	Spindle positioning, let spindle stop at a specified position
M30	Program end, return to starting point
M98	Call the sub-program
M99	From sub-program return to main program

1. M00: Program dwell

When CNC executes M00 command, the spindle will stop to rotate, feed will dwell, cutting oil will stop, it is convenient to size check and compensate for operator ; We can specify the program is dwell or not by “M00 cancel switch” on the interface.

2. M01: Selective program dwell

M01 is similar to M00 ; but M01 is controlled by "selective stop" ; when the switch is ON, M01 is effective, program dwell ; When the switch is OFF, then M01 is not effective.

3. M02: program end

When there is M02 command in the end of main program. When CNC executes this command, machine will stop, if we need to execute the program again, we must click "RESET", and then click "program start".

4. M03: spindle rotate (CW)

M03 command can let the spindle rotate CW, it can use with S function, spindle can rotate CW in specified speed.

5. M04: spindle rotate (CCW)

M04 command can let the spindle rotate CCW

6. M05: spindle stop

M05 command can let spindle stop, when you want to change the gear or change the rotate direction, must use M05 to stop the spindle before we change the gear or change the rotate direction.

7. M06: tool exchange

M06 command can execute tool exchange, this command does not include tool selection, it must use with T__function.

8. M08/M09: coolant liquid ON/OFF

M08 command for coolant liquid ON, M09 for OFF

9. M19: spindle positioning stop

M19 command let spindle positioning on a specified corner

10. M30: program end

M30 command for program ends, when program execute M30 command, will action stops, and the memory will return to the initial of the program.

11. M98/M99: sub-program control

Sub-program is parameter which has fixed perform method or be executed usually, we prepare first and put it into memory, when we need to use, we can call by main program. We use M98 to call the sub-program and use M99 to end that.

Command form:

M98 P__ H__ L__; //Sub-program called

P is specified number of program(when we ignore P, it specify the program itself, and it is only used in memory perform or MDI perform)

H is the number of ranking in specified program.

L is the number of repeats that sub-program executes.

M99 P__ ; //Sub-program end

P is the line number that returns to main program after sub-program ends.

Milling machine parameter description:

NO.	Description	Range	Unit	Operation description
4002	Drilling cycle tool return value	[0,999999999]	LIU	LIU Min input unit, this unit is effective by G70/G71.
4010	The feed depth percentage of milling process cycle plane	[1,100]		Percentage of perform feed depth to tool diameter on perform cycle
4020	Boring spindle stop direction	[0,3]		XY work plan 0:X+,1:X-,2:Y+,3:Y- ZX work plan 0:Z+,1:Z-,2:X+,3:X- YZ work plan 0:Y+,1:Y-,2:Z+,3:Z-