

✧ Preface

Thanks for choosing the E550 series universal low-power inverter produced by Shenzhen Sunfar Electric Technologies Co., Ltd.

This Manual is the operating manual for E550 series universal low-power inverters. It provides all relevant instructions and precautions for installation, wiring, functional parameters, daily care and maintenance, fault diagnosis and troubleshooting of E550 series inverters.

In order to use this series of inverters correctly, guarantee product's best performance and ensure safety of users and equipment, be sure to read this manual carefully before using E550 series inverters. Improper use may cause abnormality and malfunction of the inverter, reduce its service life and even damage equipments and lead to personal injury and death etc.

This user manual is delivered with the device. Please keep it properly for future overhaul and maintenance.

Owing to constant improvement of products, all data may be changed without further notice.



SHENZHEN SUNFAR ELECTRIC TECHNOLOGIES CO., Ltd.

User Manual of E550 Series Universal Low-Power Inverter

Version V1.0

Revision Date: May 2013

CONTENTS

1. PRODUCT INTRODUCTION	1
1.1 DESCRIPTION OF INVERTER MODEL	1
1.2 MODEL OF INVERTER SERIES	1
1.3 PRODUCT APPEARANCE AND NAME OF COMPONENTS	1
1.4 PRODUCT TECHNICAL INDICATORS AND SPECIFICATIONS	2
2. INVERTER INSTALLATION	5
2.1 ENVIRONMENTAL REQUIREMENTS	5
2.2 INSTALLATION DIMENSION OF INVERTERS.....	6
3. INVERTER WIRING	9
3.1 WIRING PRECAUTIONS.....	9
3.2 WIRING OF PERIPHERAL ELEMENTS	10
3.3 BASIC WIRING	12
3.4 WIRING OF MAIN LOOP TERMINAL.....	13
3.5 WIRING OF CONTROL LOOP TERMINAL	14
4. OPERATING PANEL	15
4.1 FUNCTION DESCRIPTION OF KEYS	15
4.2 PANEL OPERATING METHOD	16
4.3 LIST OF STATUS MONITORING PARAMETERS	17
4.4 SIMPLE OPERATION OF THE INVERTER	18
5. FUNCTION PARAMETER TABLE	20

6. FUNCTION DETAILS.....	30
6.1 BASIC RUNNING PARAMETER GROUP.....	30
6.2 ANALOG INPUT OUTPUT PARAMETER GROUP.....	38
6.3 AUXILIARY RUNNING PARAMETER GROUP.....	48
6.4 MULTI-SPEED AND SENIOR RUNNING PARAMETER GROUP.....	53
6.5 COMMUNICATION FUNCTIONAL PARAMETER GROUP.....	60
6.6 PID PARAMETER GROUP.....	62
6.7 SPECIAL MACHINE PARAMETER GROUP.....	64
7. FAULT DIAGNOSIS AND COUNTERMEASURES.....	66
7.1 PROTECTION FUNCTION AND COUNTERMEASURES.....	66
7.2 FAULT RECORD QUERY.....	67
7.3 FAULT RESET.....	68
APPENDIX I: SUNFAR SELF-DEFINED COMMUNICATION PROTOCOL	69
.....	
1.1 OVERVIEW.....	69
1.2 BUS STRUCTURE AND PROTOCOL SPECIFICATION.....	70
1.3 DESCRIPTION OF FRAME FORMAT.....	77
1.4 EXAMPLE.....	82
APPENDIX II: MODBUS PROTOCOL SPECIFICATION.....	86
1.1 INTERPRETATION OF PROTOCOL FORMAT.....	86
1.2 EXAMPLE.....	90
APPENDIX III: BRAKE RESISTOR SELECTION.....	92

Precautions

E550 series universal low-power inverters are applicable to general industrial single-phase and three-phase AC asynchronous motors. If this inverter is used for equipment which is failed and may cause personal injury (e.g. nuclear control system, aviation system, safety equipment and instruments), please take care and consult with the manufacturer; if it is used for dangerous equipment, that equipment should be provided with safety protecting measures to prevent accident expansion in the case of inverter failure. The inverter is produced under strict quality assurance system. However, in order to protect your personal safety and equipment and property safety, before using this inverter, please read this chapter carefully and conduct transportation, installation, operation, commissioning and inspection according to relevant requirements.

1. Precautions of unpacking inspection

When unpacking, please confirm if

- (1) There is any damage during transportation and any components are damaged or dropped.
- (2) The model and specifications stated on the inverter nameplate is consistent with your order. If there is any omission or damage, please contact your supplier promptly.

Nameplate of the inverter

On the left side of the inverter body, there is a nameplate marked with the model and rated parameters of the inverter.

TYPE:	E550-2S0007	Inverter model
SOURCE:	1PH 220V 50/60Hz	Rated input voltage phase, voltage and frequency
OUTPUT:	1.9KVA 5.0A	Rated output capacity and current
SERIAL No.:	XXXXXXXXXX	Product serial number
		Bar code

Label on the outer box

TYPE:	E550-2S0007	Inverter model
SOURCE:	1PH 220V 50/60Hz	Rated input voltage phase, voltage and frequency
NET WEIGHT:	KG	Net weight
GROSS WEIGHT:	KG	Gross weight
VOLUME:	(mm)	Volume
SERIAL No.:	XXXXXXXXXX	Serial number
		Bar code

Weight and dimension

Model	Net weight (KG)	Gross weight (KG)	Outer box dimension(mm)
E550-2S0004(B)	0.82	1.00	195×115×175
E550-2S0007(B)	0.82	1.00	195×115×175
E550-4T0007(B)	1.54	1.84	223×135×195
E550-4T0015(B)/E550-2S0015(B)	1.54	1.84	223×135×195
E550-4T0022(B)/E550-2S0022(B)	1.54	1.84	223×135×195
E550-4T0030(B)/E550-2S0030(B)	1.82	2.54	270×160×215
E550-4T0040(B)/E550-2S0040(B)	1.82	2.54	270×160×215

We have strict quality assurance system for the products in terms of manufacturing, packing and transportation. In case of any careless omission, please contact us or local agent immediately. We will address the problem at first time.

2. Safety precautions

In this manual, the wordings of “Danger” and “Caution” are defined as below.



Danger: Serious damage to the equipment or personal injuries may be caused if operating without following requirements.



Caution: Moderate injuries or minor injuries of personnel and material loss may be caused if operating without following requirements.

2.1 Installation

1. The inverter shall not be installed on combustibles.
2. The frequency inverter shall not be installed at places with direct sunlight.
3. The frequency inverter of this series shall not be installed in the environment of explosive gases, for fear of the danger of explosion.
4. No foreign matter is allowed to be dropped into the frequency inverter, for fear of causing fires or injury.
5. During installation, the frequency inverter shall be installed at the place able to bear its weight; otherwise, it may fall down or damage properties.



The inverter shall not be dismantled or modified without authorization.

2.2 Wiring

1. Wire diameter shall be selected according to applicable electric code, and wiring shall be done by qualified technicians.
2. Wiring shall not be started unless the power supply of the inverter is completely disconnected.
3. The grounding terminal of the inverter must be reliably grounded; otherwise, there can be a danger of electric shock.
4. Before wiring, make sure the power supply has been disconnected for over 10minutes; otherwise, there may be a danger of electric shock.
5. The electronic elements in the inverter is quite sensitive to static electricity, hence no foreign articles shall be placed into the inverter or contact the main board.



No alternating current power supply is allowed to be connected onto the U, V, and W of the inverter.

2.3 Maintenance



Wiring, inspection and other maintenance work shall not be done until the power supply is disconnected for 10 minutes.

3. Precautions of use

In this manual, the wordings of “Tip” and “Attention” are defined as below:



Tip: To give some useful information.



Attention: To indicate any precautions during operation.

1. The inverter shall be installed in the place with good ventilation.
2. The motor’s temperature can be a little higher than that of industrial frequency power during operation of the inverter, which is abnormal.
3. With long-term operation at low speed, the operation life of motor can be

affected due to the poorer heat dissipation effect. In this case, special frequency converter shall be selected or the motor's load shall be decreased.

4. When the altitude is over 1000m, the inverter shall be derated. Increase of altitude for every 1500 m shall be ground for derating by 10%.
5. If the operating environment is beyond the allowed conditions of the inverter, please consult the manufacturer.



The inverter's output terminal shall not be connected to any filter capacitor or other RC absorption equipment.

4. Scrapping precautions

Following attentions shall be paid when the inverter and its components are abandoned.

Explosion of the electrolytic capacitor: electrolytic capacitor in the frequency converter may cause explosion while burning.

Waste gas from plastic burning: harmful and toxic gas may be produced during combustion of plastic and rubber products of the converter.

Disposal: please dispose of inverters as industrial wastes.

1 Product Introduction

1.1 Description of inverter model

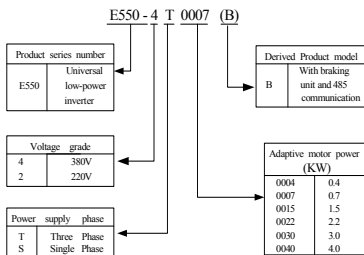

1.2 Model of inverter series

Inverter model	Rated capacity (KVA)	Rated output current (A)	Adaptive motor power (KW)
E550-2S0004(B)	1.1	3.0	0.4
E550-2S0007(B)	1.9	5.0	0.75
E550-2S0015(B)	2.9	7.5	1.5
E550-2S0022(B)	3.8	10.0	2.2
E550-2S0030(B)	5.3	14.0	3.0
E550-2S0040(B)	6.3	16.5	4.0
E550-4T0007(B)	1.6	2.5	0.75
E550-4T0015(B)	3.0	4.5	1.5
E550-4T0022(B)	3.6	5.5	2.2
E550-4T0030(B)	5.0	7.5	3.0
E550-4T0040(B)	6.3	9.5	4.0

1.3 Product appearance and name of components

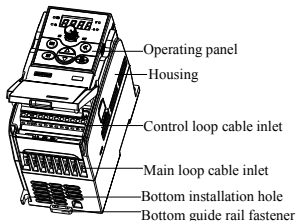

Figure 1-1 Appearance and Part Name of Category I Inverters
Applicable models: E550-2S0004 (B) / E550-2S0007 (B)

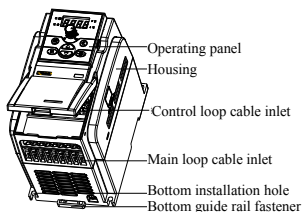

Figure 1-2 Appearance and Component Name of Category II Inverters

Applicable models:

E550-2S0015(B)~E550-2S0022(B)/
E550-4T0007(B)~E550-4T0022(B)

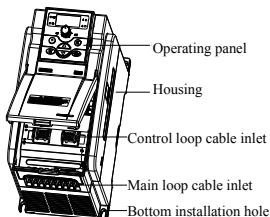

Figure 1-3 Appearance and Component Name of Category III Inverters

Applicable models:

E550-2S0030(B)~E550-2S0040(B)/
E550-4T0030(B)~E550-4T0040(B)

1.4 Product technical indicators and specifications

Power range of E550 series: 2S0004 (B) ~2S0040 (B) /4T0007 (B) ~4T0040 (B).

Technical index and typical function of E550 series

Input	Rated voltage, frequency	Three phase (4T# series) 380V50/60Hz	Single phase (2S# series) 220V50/60Hz
	Allowed variation range of voltage	300V ~ 460V	180V ~ 260V
Output	Voltage	0 ~ 380V	0~220V
	Frequency	0.0~1000Hz	
	Overload capacity	110%--long term; 150%--1 minute; 180%--2 second	
Control mode		VVVF space voltage vector	
Control Characteristics	Frequency set resolution	Analog terminal input	0.1% of the maximum output frequency
		Digital setting	0.1Hz
	Frequency precision	Analog input	Within 0.1% of the maximum output frequency
		Digital input	Within 0.1% of the set output frequency
V/F curve (Voltage frequency characteristics)		Reference frequency can be set within 5~1000Hz, and multi-node V/F curve can be randomly set.	
Torque increase		Manual setting: 0.0~20.0% of rated output.	

	Automatic current limiting and voltage limiting	Automatically detect motor's stator current and voltage and control it within allowable range according to special algorithm, regardless of any running process like acceleration, deceleration or static running.	
	Under voltage limiting during running	Especially for users of low-grid voltage and frequently fluctuating grid voltage. Even within the voltage range lower than allowable value, the system can maintain longest running time according to special algorithm and residual capacity distribution strategy.	
Typical functions	Multispeed control	7-section programmable multispeed control and 5 kinds of running modes available for selection	
	Optional built-in PID controller	Internal integrated optimized PID controller, allowing for simple closed-loop control.	
	RS485 communication and linkage control	SUNFAR user-defined protocol or MODBUS protocol.	
	Frequency setting	Analog input	DC voltage 0-10V, and DC current 0-20mA (optional)
		Digital input	Operating panel setting, potentiometer setting, RS485 port setting, UP/DW terminal control, and multiple combined setting with analog input.
	Output signal	Relay and OC output	One channel OC output and One channel relay output (TA, TC), with up to 16 kinds of optional meanings.
		Analog output	One channel 0-10V voltage signal, and upper and lower limit can be set.
	Automatic voltage regulation running	Three kinds of voltage regulation modes including dynamic, static and none are available for selection according to different requirements, so as to achieve most stable running effect.	
	Setting of acceleration and deceleration time	0.1~600.0Sec continues setting, and deceleration and acceleration curve S type and liner mode are optional.	
	Timer	One built-in timer	
Running function	Setting of upper and lower limiting frequency, REV running limiting, RS485 communication, and control of progress increase and decrease of frequency, etc.		
Display	Display of operation panel	Running status	
	Alarm content	Output frequency, output current, output voltage, motor revolution, set frequency, module temperature, analog input and output and so on.	
	Protection/alarm function	The nearest 4 times of fault records, five items of running parameter records at the time of latest fault trip including, the output frequency, output current, output voltage, DC voltage and modular temperature.	
	Protection/alarm function	Over current, overvoltage, under voltage, overheat, short circuit, internal memory fault, etc	

Environment	Surrounding temperature	-10°C to +40°C (no freezing)
	Surrounding humidity	90% below (no frosting)
	Surrounding environment	Indoor (Free of direct sunlight, corrosion, flammable gas, oil mist and dusts)
	Altitude	Below 1000m
	Protecting grade	IP20
	Cooling mode	Forced air cooling
Installation mode	Rail type /wall-mounted	

2 Inverter Installation

2.1 Environmental requirements

This series of inverters are wall-mounted products and shall be vertically installed to facilitate air circulation and heat dissipation. Following attentions shall be paid for selecting installation environments.



1. The ambient temperature shall be within -10°C — 40°C . High-temperature and humid places shall be avoided, and the inverter shall be better placed in a place with humidity lower than 90% and without frosting.
2. Direct sunshine should be avoided.
3. The inverter should be away from flammable, explosive and corrosive gas and liquid.
4. The environment should be free of dust, floating fibers and metal particles.
5. The installation surface should be solid without ventilation.
6. The inverter should be away from electromagnetic interference sources.

If you have any special installation requirements, please contact us in advance.

See Figure 2-1-A for installation spacing and distance requirement for single inverter. Enough space should be leaved around the inverter. For installation of multiple inverters, baffle plate should be applied between inverters to ensure good heat dissipation, as shown in Figure 2-1-B.

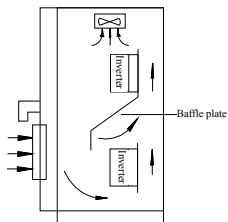
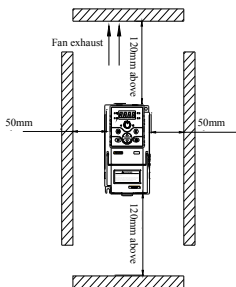

Figure 2-1-A Installation Spacing Distance

Figure 2-1-B Installation of Multiple Inverters

2.2 Installation dimension of inverters

2.2.1 Installation dimension of inverters

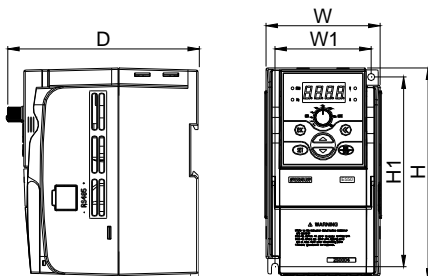

Figure 2-2-A Inverter Installation Dimension 1

Applicable models: E550-2S0004 (B) ~E550-2S0007 (B), shown in Figure 2-2-A

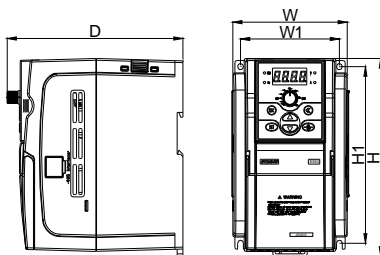

Figure 2-2-B Inverter Installation Dimension 2

Applicable models: E550-2S0015(B)~2S0040(B)/E550-4T0007(B)~4T0040(B), as shown in Figure 2-2-B.

The specific installation dimensions of E550 series inverters are shown in following table:

Inverter model (three-phase 380V)	Inverter model (single-phase 220V)	W1	W	H1	H	D	Screw specification
-	E550-2S0004(B)	67.5	81.5	132.5	148	134.5	M4
-	E550-2S0007(B)						
E550-4T0007(B)	-	86.5	101.5	147.5	165	154.5	M4
E550-4T0015(B)	E550-2S0015(B)						
E550-4T0022(B)	E550-2S0022(B)						
E550-4T0030(B)	E550-2S0030(B)	100	110	190	205	169.5	M5
E550-4T0040(B)	E550-2S0040(B)						

2.2.2 Installation dimensions of optionals

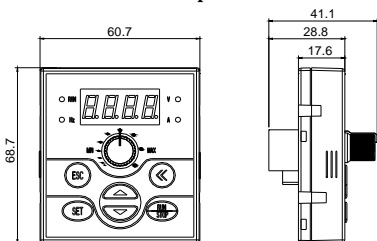

Figure 2-2-C Small Keyboard Installation Dimension

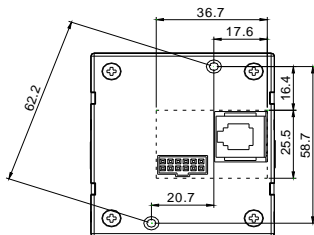

Figure 2-2-D Installation Dimension of Small Keyboard Base

Note: Assemble with M3 screws and pay attention to the whole site and opening dimension within the dotted lines.

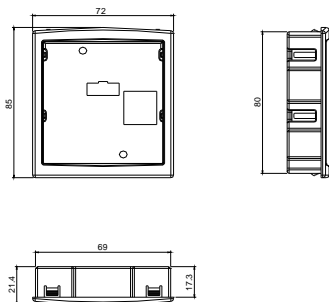

Figure 2-2-E Installation Dimension of Small Keyboard Base

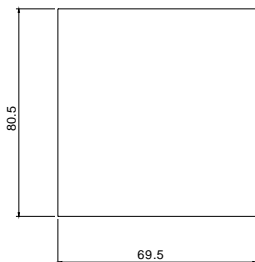

Figure 2-2-F Opening Dimension of Small Keyboard Base

Note: See Figure 2-2-F for the recommended opening dimension of small keyboard base

3 Inverter Wiring

3.1 Wiring precautions

- (1) Make sure intermediate circuit breaker is connected between the frequency inverter and power supply to avoid expanded accident when the frequency inverter is faulty.
- (2) In order to reduce electromagnetic interference, please connect surge sorber on the coil of electromagnetic contactor, relay and etc. in the surrounding circuit of the frequency inverter.
- (3) Please use shielded wire of above 0.3mm^2 for the wiring of such analog signals as frequency setting terminal AI and instrument loop (AO), etc. The shielding layer shall be connected on the grounding terminal E of the frequency inverter with wiring length less than 30m.
- (4) The stranded wire or shielded wire of above 0.75mm^2 shall be selected for the wiring of input and output loop (X1-X4) of relay; and the shielded layer shall be connected to the common port CM of control terminals, with wiring length less than 50 m.
- (5) The control wire shall be separated from the power line of major loop; it shall be at a distance of above 10cm for parallel wiring and vertical for cross wiring.
- (6) The connecting wire between the inverter and the motor shall be less than 30m; and when it is longer than 30m, the carrier frequency of the inverter shall be appropriately reduced.
- (7) All leading wires shall be fully fastened with terminals to ensure good contact.
- (8) The pressurization of all the leading wires shall be in compliance with the voltage class of the frequency inverter.



Absorption capacitor or other RC absorbers shall not be installed at U, V and W output end of the frequency inverter, as shown in figure 3-1.

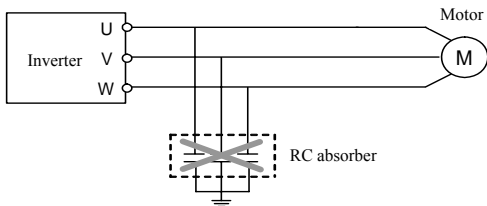

Figure 3-1 Forbidding connecting a RC absorber at the output terminal

3.2 Wiring of peripheral elements

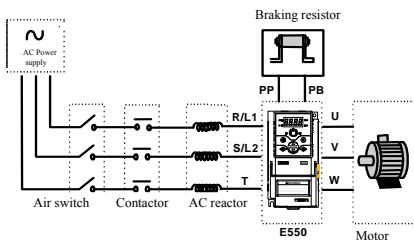

Figure 3-2 Inverter Wiring

◆ Power supply

The inverter shall be provided with power in accordance with specification of input power supply designated by this operating manual

◆ Air switch

- 1) When the frequency inverter is maintained or not in use for a long time,
- 2) the air switch will separate the frequency inverter from the power supply;
- 3) When the input side of the frequency inverter has failures like short circuit, the air switch can provide protection.

◆ Contactor

It can conveniently control power-supply and power disconnection of the inverter, and the power-on and power-off of the motor.

◆ **AC reactor**

- 1) To promote power factor;
- 2) To reduce harmonic input of the inverter against the grid;
- 3) Weaken influenced caused by unbalanced voltage of three-phase power supply.

◆ **Brake resistance**

When the motor is at the dynamic braking status, it can avoid producing over high pumping voltage in the DC loop.

Recommended specifications are shown in following table:

Inverter model	Adaptive motor (KW)	Wire specification (main loop) (mm ²)	Air circuit breaker (A)	Electromagnetic contactor (A)
E550-2S0004	0.4	1.5	16	6
E550-2S0007	0.75	2.5	20	12
E550-2S0015	1.5	2.5	32	18
E550-2S0022	2.2	4.0	32	18
E550-2S0030	3.0	6.0	40	32
E550-2S0040	4.0	6.0	40	32
E550-4T0007	0.75	1.0	10	6
E550-4T0015	1.5	1.5	16	12
E550-4T0022	2.2	2.5	16	12
E550-4T0030	3.0	3.0	20	18
E550-4T0040	4.0	4.0	32	18

3.3 Basic wiring

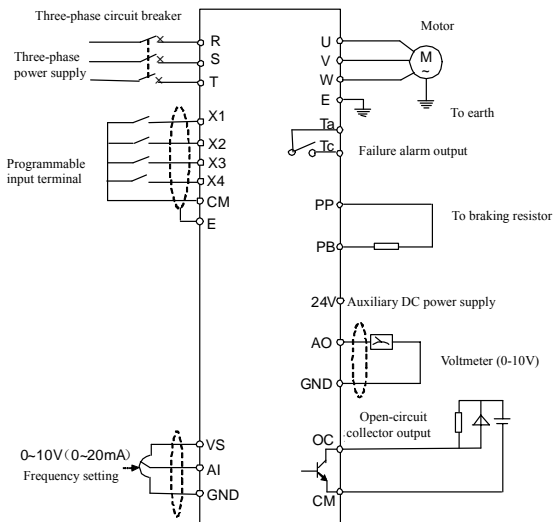

Figure 3-3 Basic Wiring of Inverter

3.4 Wiring of main loop terminal

Category II main loop terminal

Applicable models: E550-2S0004(B)~E550-2S0007(B)

<p>Power supply input</p>	Symbol	Function
	PP	DC side voltage positive terminal
	PB	Braking resistor can be connected between PP and PB
	L1, L2	To grid single-phase AC 220V power supply
	U, V, W	To three-phase AC 220V motor
E	Earthing terminal	

Category II main loop terminal

Applicable models: E550-2S00015(B)~E550-2S0022(B) & E550-4T00007(B)~E550-4T0022 (B)

<p>Single-phase/three-phase Power supply input</p>	Symbol	Function
	PP	DC side voltage positive terminal
	PB	Braking resistor can be connected between PP and PB
	$\frac{L1}{R}, \frac{L2}{S}, T$	To grid single-phase AC 220V/ three-phase 380V power supply
	U, V, W	To three-phase AC 220V/380V motor
E	Earthing terminal	

Category III main loop terminal

Applicable models: E550-2S0030 (B)~E550-2S0040(B) & E550-4T00030(B)~E550-4T0040(B)

<p>Braking resistor</p> <p>Single-phase/three-phase Power supply input</p>	Symbol	Function
	PP	DC side voltage positive terminal
	PB	Braking resistor can be connected between PP and PB
	$\frac{L1}{R}, \frac{L2}{S}, T$	To grid single-phase AC 220V/ three-phase 380V power supply
	U, V, W	To three-phase AC 220V/380V motor
E	Earthing terminal	

3.5 Wiring of control loop terminal

(1) Diagram of control loop terminal

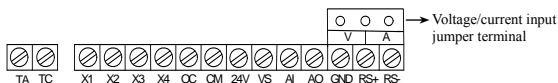

(2) Function description of control loop terminal

Type	Terminal symbol	Terminal function	Remarks
Power supply	VS	Externally providing +10V (0~20mA) power supply	-
	24V	External providing +24V (0~50mA) power supply (CM terminal is the power grand).	-
Analog input	AI	Voltage signal input terminal (when jumper terminal is connected to V terminal)	0~10V
		Current signal input terminal (when jumper terminal is connected to A terminal)	0~20mA
Control terminal	GND	Common port of analog input signal (VS power grand)	-
	X1	Multifunctional input terminal 1	The specific function of multifunctional input terminal is to be set by parameter [F1.08] – [F1.11], effective when the terminal and CM end is closed.
	X2	Multifunctional input terminal 2	
	X3	Multifunctional input terminal 3	
X4	Multifunctional input terminal 4		
Analog output	AO	Programmable voltage signal output terminal (external voltage meter (set by [F1.05])	Voltage signal output 0-10V
OC output	OC	Programmable open-circuit collector output, set by parameter [F1.13]	Maximum load current 150mA and maximum withstanding voltage 24V.
Programmable output	TA TC	TA-TC normally open; When TA-TC is closed, effective when parameter [F1.14] selects output.	Contact capacity: AC 250V, 1A resistive load
Communication	RS+	485 communication port	-
	RS-	485 communication port	-

4 Operating Panel

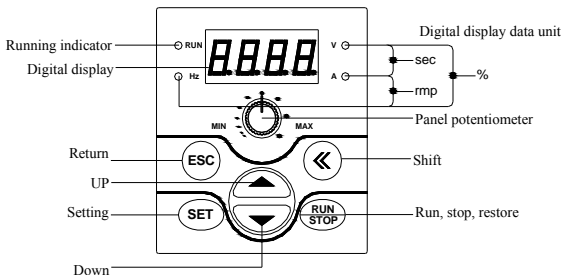





Figure 4-1 Operating Panel Sketch

Note: E550 series keyboard port can be compatible with SUNFAR E300 and E310 series, and other series keyboard is not compatible. Do not make confusion.

4.1 Function description of keys

Keys	Function Description
Digital display	Display the current operating status parameters and setting parameters of the frequency inverter.
A, Hz, V	Display the measurement unit corresponding to the main digital display data.
RUN	Operating indicator, indicating the inverter is running, and there is output voltage at the output terminals U, V and W.
	Data modification key. It is used to modify functional code or parameters. At the status monitoring mode, if the frequency command channel is at the digital setting mode ([F0.00]=0), press this key to directly modify the frequency set value.
	Back key. At the normal monitoring mode, press this key to enter the non-normal monitoring mode/monitoring parameter inquiry mode to see the operating status parameters of the inverter. At any other operating status, separately press this key to back to the previous status.
	Set key. Confirm the current status or parameter (parameters are stored in the internal memorizer) and enter the next function menu.

Keys	Function Description
	RUN/STOP command key. When the command channel selects control panel ([F0.02] = ##0), this key is effective. The key is a trigger key. When the inverter is at the stop status, press this key to input stop command to stop running. At the inverter fault status, this key is also used as the fault reset key.
	Shift key. When modifying data with any data modification key, press this key to select the data digit to be modified, and the selected digit will flash.
	Panel potentiometer. When the inverter's running frequency is set by the potentiometer on the operating meter (F0.00=3), rotate the potentiometer knob counterclockwise to decrease running frequency, and rotate it clockwise to increase running frequency.

4.2 Panel operating method

(1) Status parameter inquiry (example)

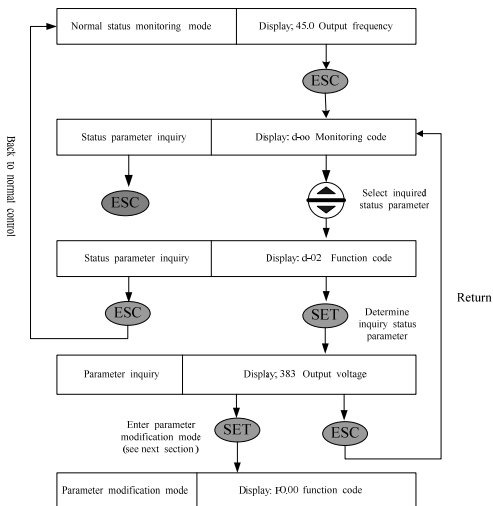

(2) Parameter inquiry and modification (example)

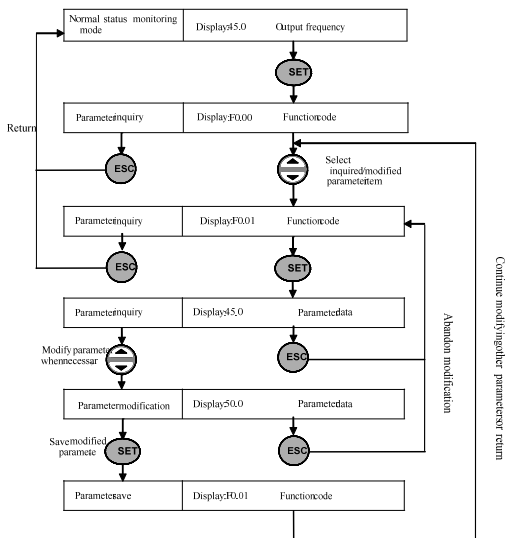

4.3 List of status monitoring parameters

Monitoring code	Content	Unit
d-00	Inverter's current output frequency	Hz
d-01	Inverter's current output current (effective value)	A
d-02	Inverter's current output voltage (effective value)	V
d-03	Motor revolution	rpm
d-04	Voltage at the DC terminal in the inverter	V
d-05	Inverter's input AC voltage (effective value)	V
d-06	Set frequency	Hz
d-07	Analog input AI	V
d-08	Running liner speed	
d-09	Set liner speed	
d-10	Input terminal status	
d-11	Module temperature	°C
d-12	Analog output AO	V
d-13	Timer value	

Monitoring code	Content	Unit
d-14	Reserve	
d-15	Reserve	
d-16	Reserve	
d-17	Reserve	
d-18	Reserve	
d-19	Reserve	
d-20	Reserve	
d-21	Reserve	
d-22	Reserve	
d-23	First fault record	
d-24	Second fault record	
d-25	Third fault record	
d-26	Forth fault record	
d-27	Output frequency at the time of recent fault	Hz
d-28	Output currency at the time of recent fault	A
d-29	Output voltage at the time of recent fault	V
d-30	DC voltage at the time of recent fault	V
d-31	Module temperature at the time of recent fault	

4.4 Simple operation of the inverter

4.4.1 Initial setting

(1) Channel selection for frequency input ([F0.00])

Inverter's initial setting varies from each other according to different models.

When the parameter is set to 0, the inverter's frequency setting will be set through the panel digit.

(2) Selection of running command input channel ([F0.02])

The inverter's initial setting varies according to different models. When this parameter is set to [F0.02] =###0, the inverter's start and stop control will be completed through  key on the operating panel.

4.4.2 Simple running



It is absolutely forbidden to connect the power cord to the output U, V, W of the frequency inverter.

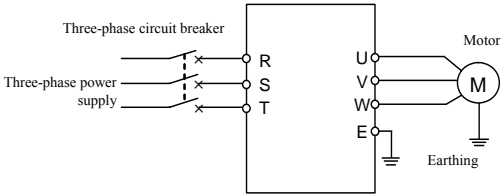





Figure 4-2 Simple Running Wiring Diagram

- ① Connect wires as per Figure 4-2;
- ② Switch on the power supply after confirming that the wires are connected correctly, and the inverter will firstly display “P.oFF” and then “0”.
- ③ Confirm that the frequency setting channel is at the digit setting model ([F0.00] = 0);
- ④ It is required to set parameter [F0.12] and [F0.13] according to the rated nameplate data on the inverter’s dragging motor.
- ⑤ Press  key to start the inverter and the inverter will input 0 frequency, displaying “0.0”.
- ⑥ Press Up of  key to increase set frequency, and the output frequency of the inverter will increase and the motor revolution will also increase.
- ⑦ Check if the motor run normally. In case of any abnormality, stop running the motor immediately and disconnect power supply. Do not run the motor until fault cause is found.
- ⑧ Press Down on the  key to decrease set frequency.
- ⑨ Press  key again to stop running and cut off the power supply.



The default value of the carrier frequency is fixed (1.5-10 KHz). If the motor is completely empty-load, slight oscillation may occur sometimes in the operation under high carrier frequency. At this time, please reduce the setting value of the carrier frequency. (Parameter [F0.08]).

5 Function Parameter Table

Parameter Type	Function Code	Name	Setting Range and Description	Minimum unit	Default setting	Modification limit
Basic running parameter group	F0.00	Frequency input channel	0: Digital setting 1: External analog quantity 2: External communication 3: Panel potentiometer 4: Selection of external terminal 5: Combined setting	1	3	
	F0.01	Frequency digital setting	0.0Hz ~ Upper limiting frequency	0.1	0.0	
	F0.02	Selection of running command channel and mode	LED Units: Selection of running command channel 0: Keyboard control 1: External terminal control 2: communication port LED Tens: Running command mode selection 0: Two-line mode 1 1: Two-line mode 2 2: Three-line mode 3: Special mode for terminal machine LED Hundreds: REV prevention 0: REV prevention void 1: REV prevention effective LED Kilobit: Power-on auto start 0: Power-on auto start forbidden 1: Power-on auto start allowed	1	1000	
	F0.03	Lower limiting frequency	0.0Hz ~ [F0.04]	0.1	0.0	
	F0.04	Upper limiting frequency	[F0.03] ~ 1000Hz	0.1	50.0	
	F0.05	Acceleration time	0.1 ~ 600.0 Sec	0.1	5.0	
	F0.06	Deceleration time	0.1 ~ 600.0 Sec	0.1	5.0	
	F0.07	Acceleration and deceleration characteristic parameter	0: Straight line acceleration and deceleration 1: S Curve acceleration and deceleration	1	0	

Parameter Type	Function Code	Name	Setting Range and Description	Minimum unit	Default setting	Modification limit
Basic running parameter group	F0.08	Carrier frequency	1.5 ~ 10.0kHz	0.1	8.0	
	F0.09	Modulation mode	0: Asynchronous 1: Synchronous	1	0	×
	F0.10	Parameter write and protection	1: Only allowing to rewrite F0.01 parameter and this parameter 2: Only allowing to rewrite this parameter Other values: All parameters are	1	0	
	F0.11	Torque boost	0.0 ~ 20.0 (%)	0.1	6.0	
	F0.12	Basic running frequency	5.0Hz ~ Upper limiting frequency	0.1	50.0	
	F0.13	Maximum output voltage	25 ~ 250V/ 50 ~ 500V	1	220/ 440	
	F0.14	Jog acceleration time	0.1~ 600.0 S	0.1	5.0	
	F0.15	Jog deceleration time	0.1~ 600.0 S	0.1	5.0	
	F0.16	FWD jog frequency	0.0Hz~[F0.04]	0.1	10.0	
	F0.17	REV jog frequency	0.0Hz~[F0.04]	0.1	10.0	
	F0.18	Auxiliary function setting	LED Units: running direction 0: Consistent with the set direction 1: Reverse to the set direction LED Tens: Jog priority selection 0: Highest 1: Lowest	1	0000	
	F0.19	Lower limiting frequency functioning mode	0: Output lower limiting frequency when it is lower than the lower limiting frequency 1: Output zero frequency when it is lower than the lower limiting frequency	1	0	
	F0.20	Reserve				
	F0.21	Parameter protection password	0~9999	1	0	
	F0.22	UP/DW speed	0.1~50.0Hz	0.1	5.0	
	F0.23	Reserve				
	F0.24	Reserve				

Parameter Type	Function Code	Name	Setting Range and Description	Minimum unit	Default setting	Modification limit
Input and output parameter group	F1.00	AI input lower limiting voltage	0.0 V ~ [F1.01]	0.1	0.0	F1.00
	F1.01	AI input upper limiting voltage	[F1.00] ~ 10.0 V	0.1	10.0	F1.01
	F1.02	AI input filter time	0.01~1.00S	0.01	0.01	F1.02
	F1.03	Minimum set frequency	0.0Hz ~ [F1.04]	0.1	0.0	F1.03
	F1.04	Maximum set frequency	[F1.03] ~ [F0.04]	0.1	50.0	F1.04
	F1.05	Analog output selection	0: output frequency 1: output current 2: output voltage	1	0	F1.05
	F1.06	AO output lower limit	0.0V ~ [F1.07]	0.1	0.0	F1.06
	F1.07	AO output upper limit	[F1.06] ~ 10.0V	0.1	10.0	F1.07
	F1.08	Function selection of input terminal 1	0~29	1	11	F1.08
	F1.09	Function selection of input terminal 2	0~29	1	1	F1.09
	F1.10	Function selection Of input terminal 3	0~29	1	2	F1.10
	F1.11	Function selection Of input terminal 4	0~29	1	3	F1.11
	F1.12	Input channel characteristic selection	0000~1111H	1	0000	F1.12
	F1.13	OC output function selection	0~15	1	0	F1.13
	F1.14	Relay output TA/TC function selection	0~15	1	8	F1.14

Parameter Type	Function Code	Name	Setting Range and Description	Minimum unit	Default setting	Modification limit
Input and output parameter group	F1.15	OC and relay output characteristic selection	LED Units: OC output selection 0: OC output positive characteristics 1: OC output negative characteristics LED Tens: relay output selection 0: relay output positive characteristics (normally open) 1: relay output negative characteristics (normally closed)	1	0000	
	F1.16	Relay action delay	0.0S~5.0S	0.1	0	
	F1.17	Frequency reaching detecting amplitude	0.0 ~ 20.0Hz	0.1	5.0	
	F1.18	FDT (frequency level) setting	0.0 ~[F0.04]	0.1	10.0	
	F1.19	FDT output delay time	0.0 ~ 5.0Sec	0.1	2.0	×
	F1.20	Overload alarm level	50 ~200(%)	1	110	
	F1.21	Overload alarm delay time	0.0 ~ 60.0 Sec	0.1	2.0	×
	F1.22	Reserve				
	F1.23	Reserve				
	F1.24	Batter number of terminal machine	1~100	1	10	
	F1.25	Designated counting value	1~[F1.26]	1	5	
	F1.26	Final counting value	[F1.25]~60000	1	100	
	F1.27	Reserve				

Parameter Type	Function Code	Name	Setting Range and Description	Minimum unit	Default setting	Modification limit
Input and output parameter group	F1.28	Frequency input channel combination	0: External voltage + panel potentiometer 1: External voltage+panel potentiometer + Digital setting 2:Communication + external voltage 3: Communication + external voltage + panel potentiometer 4:Communication + digital-panel potentiometer 5:Communication - external voltage 6:Communication + external voltage - panel potentiometer 7:External voltage + digital - panel potentiometer 8:Panel potentiometer - Digital setting 9:UP/DW+ External voltage 10: UP/DW + panel potentiometer + external voltage	1	0	
	F1.29 - F1.31	Reserve				
	Auxiliary running parameter group	F2.00	Start frequency	0.0 ~ 50.0Hz	0.1	1.0
F2.01		Start frequency duration	0.0 ~ 20.0 Sec	0.1	0.0	×
F2.02		Stop mode	0: Deceleration stop 1: Free stop	1	0	
F2.03		Stop DC braking frequency	0.0~[F0.04]	0.1	3.0	
F2.04		Stop DC braking current	0 ~ 100(%)	1	10	×
F2.05		Stop DC braking time	0.0 ~ 20.0 Sec	1	0.0	
F2.06		Acceleration torque level	110 ~ 200(%)	1	170	
F2.07		Motor overload protecting coefficient	50 ~ 110(%)	1	110	
F2.08		Dynamic braking Initial voltage ⁽¹⁾	300 ~ 400V/ 600 ~ 800V	1	370 740	
F2.09		Reserve				

Function Parameter Table 25

Parameter Type	Function Code	Name	Setting Range and Description	Minimum unit	Default setting	Modification limit
	F2.10	Reserve				
	F2.11	V/F frequency 1	0.0~[F2.13]	0.1	0.0	
	F2.12	V/F voltage 1	0~[F2.14]	1	0	
	F2.13	V/F frequency 2	[F2.11]~[F2.15]	0.1	0.0	
	F2.14	V/F voltage 2	[F2.12]~[F2.16]	1	0	
	Continued	F2.15	V/F frequency 3	[F2.13]~[F0.12]	0.1	0.0
F2.16		V/F voltage 3	[F2.14]~[F0.13]	1	0	
F2.17		Reserve				
F2.18		Automatic voltage regulation	0: Void 1: Deceleration void 2: Effective	1	0	
F2.19		Pairs of motor poles	1~16	1	2	
F2.20		Reserve				
Multispeed and senior running parameter group	F3.00	Multi-speed frequency 1	0.0Hz ~ Upper limiting frequency	0.1	35.0	
	F3.01	Multi-speed frequency 2	0.0Hz ~ upper limiting frequency	0.1	15.0	
	F3.02	Multi-speed frequency 3	0.0Hz ~ upper limiting frequency	0.1	3.0	
	F3.03	Multi-speed frequency 4	0.0Hz ~ upper limiting frequency	0.1	20.0	
	F3.04	Multi-speed frequency 5	0.0Hz ~ upper limiting frequency	0.1	25.0	
	F3.05	Multi-speed frequency 6	0.0 Hz~ upper limiting frequency	0.1	30.0	
	F3.06	Multi-speed frequency 7	0.0 Hz~ upper limiting frequency	0.1	35.0	
	F3.07	Liner speed coefficient setting	0.01 ~ 100.00	0.01	1.00	
	F3.08	Monitoring parameter selection	0 ~ 22	1	0	
	F3.09	Parameter inquiry and modification authority	0 ~ 9999	1	1700	
F3.10	Parameter initialization	0: No action 1: Standard initialization 2: Fault elimination record 3: Complete initialization	1	0	×	

Parameter Type	Function Code	Name	Setting Range and Description	Minimum unit	Default setting	Modification limit
Multispeed and senior running parameter group	F3.11	Under voltage protection level	180 ~ 230V / 360 ~ 460V	1	200/ 400	
	F3.12	Overvoltage suppression level	350 ~ 400V / 700 ~ 800V	1	360/ 720	
	F3.13	Current amplitude limiting level	150 ~ 250(%)	1	180	
	F3.14	Program version	1200 ~ 1299	1	1200	
	F3.15	Reserve				
	F3.16	Reserve				
	F3.17	Multi-speed running mode	Units: PLC action selection 0: No action 1: Action 2: Conditional action Tens: PLC operating mode selection 0: Single cycle mode 1: Single cycle stop mode 2: Final value keeping mode 3: Set value keeping mode 4: Continuous cycle mode	1	0000	
	F3.18	Stage 1 running time	0.0S~6000.0S	0.1	0.0	
	F3.19	Stage 2 running time	0.0S~6000.0S	0.1	0.0	
	F3.20	Stage 3 running time	0.0S~6000.0S	0.1	0.0	
	F3.21	Stage 4 running time	0.0S~6000.0S	0.1	0.0	
	F3.22	PLC multi-speed running direction	0000~1111H	1	0000	
	F3.23	PLC running scheduled stop	0~9999(min)	1	0	
	F3.24	Fault self-recovery times	0~5	1	3	
	F3.25	Fault self-recovery time	0.0~60.0	0.1	2.0	

Parameter Type	Function Code	Name	Setting Range and Description	Minimum unit	Default setting	Modification limit
Multispeed and sensor running parameter group	F3.26	Swing frequency running setting	LED Units: function setting 0: Swing frequency function closed 1: Swing frequency function effective 2: Swing frequency function conditionally effective LED Tens: Center frequency setting 0: Digital setting 1: Frequency channel selection	1	0000	
	F3.27	Swing frequency amplitude	0.0~50.0%	0.1	10.0	
	F3.28	Kick frequency amplitude	0.0~80.0%	0.1	0	
	F3.29	Triangular wave descending time	0.1~300.0 S	0.1	1.0	
	F3.30	Triangular wave ascending time	0.1~300.0 S	0.1	1.0	
	F3.31	Swing frequency center frequency setting	0.0~[F0.04]	0.1	0.0	
	F3.32 - F3.34	Reserve				
parameter group	F4.00	Communication setting	LED Units: Baud rate selection 0: Reserve 1: 1200 bps 2: 2400 bps 3: 4800 bps 4: 9600 bps 5: 19200 bps LED Tens: Data format selection 0: No check 1: Even parity check 2: Odd parity check LED Hundreds: protocol selection 0: SUNFAR self-defined protocol 1: MODBUS communication protocol LED Kilobit: Reserve	1	0114	×
	F4.01	Local address	0 ~ 30	1	1	
	F4.02	Local response delay	0 ~ 1000ms	1	5	

Parameter Type	Function Code	Name	Setting Range and Description	Minimum unit	Default setting	Modification limit
parameter group	F4.03	Setting of communication auxiliary function ⁽¹⁾	LED Units: Inverter main/slave setting 0: This inverter is a slave machine 1: This inverter is a main machine LED Tens: Selection of action after communication failure 0: Stop 1: Maintaining current status LED Hundreds: Data return selection 0: Data normal return 1: No data return LED Kilobit: Reserve	1	0010	
	F4.04	Communication overtime detection time ⁽¹⁾	0.1 ~ 10.0 Sec	0.1	1.0	
	F4.05	Linkage setting ratio ⁽¹⁾	0.1 ~ 10.0	0.1	1.0	
	F4.06 - F4.10	Reserve				
PID	F5.00	PID function selection	0: PID closed 1: PID enabled	1	0	
	F5.01	PID set channel	0: PID Digital setting 1: frequency input channel setting	1	0	
	F5.02	PID digital setting	0.0%~100.0%	0.1	0.0	
	F5.03	PID feed forward enabling	Units: 0: Void 1: Feed forward setting (frequency input channel)	1	0	
	F5.04	Reserve				
	F5.05	PID feedback correction	0~2.000	0.001	1.000	
	F5.06	Ratio grain	0.0~10.0	0.1	1.0	
	F5.07	Integral time	0.01~10.00	0.01	0.20	
	F5.08	Derivative time	0.0~10.00	0.01	0.0	
	F5.09	PID adjustment frequency range	0.0~100.0%	0.1	100.0	
F5.10	Breakage detection value	0.0~50.0%	0.1	5.0		

	F5.11	Breakage detection delay time	0.1~10.0Sec	0.1	5.0	
	F5.12 - F5.22	Reserve				
Special function	F6.00	Cutting function selection	0: Drag 1: Cut	1	0	
	F6.01	Cutting length	0.100~2.000	0.001	0.700	
	F6.02	Correction of liner speed coefficient	0.100~10.000	0.001	1.000	
	F6.03	Start delay	0.01~10.00	0.01	3.00	
	F6.04	Stop delay	0.01~10.00	0.01	4.00	
	F6.05	Reserve				
	F6.06	Liner cutting operating mode	0~2	1	0	
	F6.07	Forward time	0~60.0S	0.1	5.0	
	F6.08	Backward time	0~60.0S	0.1	4.0	
	F6.09	High-frequency relay Start frequency	[F6.10]~100%	1	99	
	F6.10	High-frequency relay Disconnection frequency 1	0~[F6.09]	1	98	
F6.11	High-frequency relay Disconnection frequency 2	100~200%	1	120		

Note: (1) E550 series standard model does not has this function, and only some derived models have such function.

6 Function details

6.1 Basic running parameter group

F0.00 Selection of frequency input channel/mode **Setting range: 0 ~ 5**

It is used to select setting channel/mode of inverter's running frequency.

0: Digital setting

The inverter's set frequency is set by parameter [F0.01].

1: External analog quantity

The running frequency is set by external input voltage signal (0~10V) or current signal (0~20mA); for relevant characteristics, please refer to parameter [F1.00] and [F1.01].

2: External communication

To receive frequency setting commands of upper computer or main inverter through serial RS485 port.

3: panel potentiometer

The running frequency is set by the potentiometer on the operating panel.

4: External terminal selection

The frequency input channel is confirmed by external multifunctional terminal (the selection of functional terminals is confirmed by the parameter [F1.08]~[F1.11]).

Frequency setting channel selection 2	Frequency setting channel selection 1	Frequency setting channel
0	0	Digital setting
0	1	External input signal (0~10V/0~20mA)
1	0	RS485 port
1	1	panel potentiometer

Note: It is "1" when the terminal and CM is engaged.

5: Combined setting

It is selected by [F1.28] group parameters.

F0.01 Frequency digital setting Setting range: 0.0 Hz ~upper limiting frequency

When frequency input channel selects digital setting ([F0.00] = 0), inverter's output frequency is determined by this value. When the operating panel is at the normal monitoring status, simply press  key to modify this parameter.

F0.02 Selection of running command channel and mode Setting range:0000~1132

This functional parameter is used to select inverter's running command channel and functions of  key (fratitle decimal system setting)

LED Units: running command channel selection**0: Keyboard control**

The inverter's running command is controlled by  key on the keyboard. In this mode, the status of external control terminal X1~X4 (FWD running function) can influence inverter's output phase sequence. When the external terminals X1~X4 (FWD running function) is connected to CM, the inverter's output phase sequence is negative, and when X1~X4 is disconnected with Cm, the inverter's output phase sequence is positive.

1: External terminal control

The inverter's running command is controlled by the connection and disconnection status between the multifunctional terminals X1~X4 (FWD or REV control function) and CM terminal, and its mode is determined by LED tens.

2: Serial communication port

Inverter's running command receives commands of upper commutator or main inverter through serial port. When the local inverter is set as the slave in linkage control, this mode should be selected as well.

LED Tens: selection of running command mode

0: Two-line mode1 (default mode)

command	Stop command	FEW command	REV command
Terminal status			

Two-line mode requires selecting one input terminal X1~X4 as forward control terminal FWD and the other input terminal X1~X4 as reverse control terminal REV (refer to parameter [F1.08]~[F1.11]).

1: Two-line mode 2

command	Stop	Running	FWD	REV
Terminal status				

2: Three-line mode

Three-line control mode requires selecting one input terminal (X1~X4) as forward control terminal FWD, one input terminal (X1~X4) as three-line running control terminal SW1, and one input terminal (X1~X4) as reverse control model REV (refer to parameter [F1.08]~[F1.11]). Parameter [F1.08]~[F1.11] is used to select any one from input terminals X1 - X4.

Switch function is described as below:

1. SW1 (three-line running control terminal) -inverter stop trigger switch
2. SW2 (FWD) - FEW trigger switch
3. SW3 (REV) - REV trigger switch

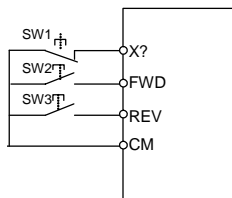

Figure 6-1 Wiring Diagram in Three-line Control Mode

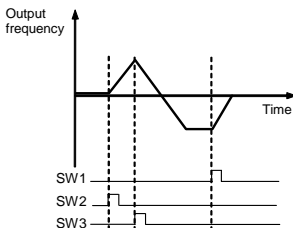

Figure 6-2 Frequency Output Diagram in Three-line Control Mode

3: Special mode for terminal machine:

This function is only applicable to special occasions such as terminal machine. X1 is used as the approach switch counting and stop signal, and X2 is start signal.

LED Hundreds: REV prevention

0: REV prevention void

1: REV prevention effective

LED Kilobit: Power-on auto start

0: Power-on auto start forbidden

1: Power-on auto start allowed

F0.03	Lower limiting frequency	Setting range: 0.0 Hz ~ [F0.
--------------	---------------------------------	-------------------------------------

This parameter is the minimum output frequency allowed for the inverter. For the functioning mode when it is lower than the lower limiting frequency, please refer to parameter [F0.19].

F0.04	Upper limiting frequency	Setting range: [F0.3] ~ 1000.0Hz
--------------	---------------------------------	---

F0.05	Acceleration time	Setting range: 0.1 ~ 600.0Sec
--------------	--------------------------	--------------------------------------

F0.06	Acceleration time	Setting range: 0.1 ~ 600.0Sec
--------------	--------------------------	--------------------------------------

It is used to define the velocity of increasing and decreasing of inverter's output frequency.

Acceleration time: the time required for output frequency accelerating from 0.0Hz to the upper limiting frequency [F0.04].

Acceleration time: the time required for output frequency decelerating from upper limiting frequency [F0.04] to 0.0Hz.

F0.07 Acceleration and deceleration characteristics parameter Setting range: 0~1

It is used to set the acceleration and deceleration characteristic parameter of inverters (fratile binary system setting).

LED UNITS: setting of inverter's acceleration and deceleration curve type.
(Refer to Figure 6-3.)

0: Straight line acceleration and deceleration

The inverter's output frequency increases or decreases at fixed speed. For most loads, this mode can be selected.

1: S curve acceleration and deceleration

The inverter's output frequency increases or decreases at varying speed. This function is mainly to reduce noise and ventilation at acceleration and deceleration and reduce load impact at start and stop.

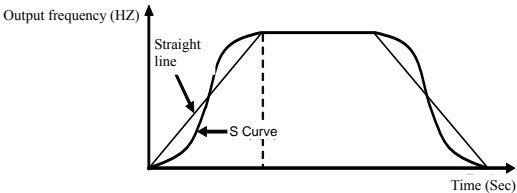

Figure 6-3 Acceleration and Deceleration Curve

F0.08**Carrier frequency****Setting range: 1.5 ~ 10.0 KHz**

This parameter is to determine the switch frequency of inverter's internal power module.

The carrier frequency mainly influences the audio noise and heat effect during running. When mute running is required, it is applicable to appropriately increase the value of the carrier frequency, but the maximum load allowable for the inverter may be somewhat reduced, accompanied by somewhat increase of interference of the inverter to the outside world. For the circumstances where the motor wire is too long, it may lead to leaking current between motor wires and between the wire and the ground. When the ambient temperature is too high and the motor load is too

high, or the inverter is failed due to above reasons, it is suggested to appropriately decrease the carrier frequency to improve thermal characteristics of the inverter.

F0.09	Modulation mode	Setting range: 0 ~ 1
--------------	------------------------	-----------------------------

This function is for selection of modulation mode.

0: Asynchronous modulation mode.

1: Synchronous modulation mode.

F0.10	Parameter write protection	Setting range: 0 ~ 9999
--------------	-----------------------------------	--------------------------------

1: Only allowing for modifying function parameter [F0.01] and this parameter.

2: Only allowing for modifying this parameter.

Other values: all parameters can be modified.

When it is forbidden to modify parameters, if it is intended to modify data, “-” will be displayed.



Some parameters cannot be modified during running. If it is attempted to modify these parameters, “—” will be displayed. To modify parameters, stop the inverter at first.

F0.11	Torque boost	Setting range: 0.0 ~ 20.0 (%)
--------------	---------------------	--------------------------------------

It is used to improve inverter's low-frequency torque characteristics. During running at low frequency, it will make compensation for boosting inverter's output voltage, as shown in Figure 6-4.

$$\text{Boost voltage} = \frac{[\text{F0.11}]}{100} \times [\text{F0.13}]$$

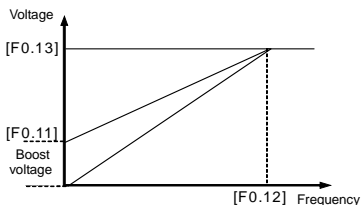

Figure 6-4 Torque Boost Sketch

F0.12 Basic running frequency Setting range: 5.0Hz ~ upper limiting frequency

F0.13 Maximum output voltage Setting range: 25 ~ 250V/50 ~ 500V

The basic running frequency is the minimum frequency at the maximum voltage of inverter output. It is generally the motor's rated frequency.

The maximum output voltage is the output voltage corresponding to the inverter output basic running frequency, and it is the motor's rated voltage.

The two items of function parameters need to be set according to motor parameter, and do not need any modification unless in special cases.

F0.14 Jog acceleration time Setting range: 0.1 ~600.0Sec

F0.15 Jog deceleration time Setting range: 0.1 ~600.0Sec

The transit acceleration and deceleration time between initial running frequency and jog frequency.

F0.16 FWD jog frequency Setting range: 0.0Hz ~[F0.04]

F0.17 REV jog frequency Setting range: 0.0Hz~[F0.04]

Jog running is a special running mode of the inverter. Within the effect period of jog signals, the inverter runs at the frequency set by this parameter.

No matter the inverter is initially stopped or running, it can receive jog signals.

F0.18 Setting of auxiliary functions**Setting range: 0000 ~ 0011****LED UNITS: Running direction**

0: Consistent with the set direction 1: Reverse with the set direction

LED Tens: Jog priority selection

0: Jog priority highest 1: Jog priority lowest

If the jog priority is set to the highest, the priority of each frequency source is as below:

Priority level	Priority	Set frequency source
High	1	Jog frequency (jog running effective)
↓	2	External terminal selection multi-speed frequency
Low	3	Selection of frequency setting channel ([F0.00] parameter)

F0.19 Lower limiting frequency functioning mode Setting range: 0000 ~ 0001

0: Output lower limiting frequency [F0.03] when it is lower than the lower limiting frequency [F0.03]

1: Output zero frequency when it is lower than the lower limiting frequency [F0.03]

This parameter is used to set hysteresis to avoid fluctuation around the set frequency zero point. When the set frequency is lower than $f(f = \text{lower limiting frequency} - 2\text{Hz})$, the inverter runs at zero frequency. When the set frequency is higher than the lower limiting frequency, the inverter runs at the set frequency. Refer to Figure 6-5.

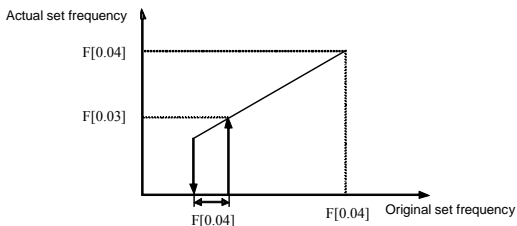

Figure 6-5 Sketch of the Function of Lower limiting frequency

F0.20 *Reserve*

F0.21 *Parameter password protection* **Setting range: 0000 ~ 9999**

F0.22 *UP/DW speed* **Setting range: 0.1~50.0Hz**

When [F0.00]=5, [F1.28]=9 or 10, and input terminal selects UP or DW function, frequency can be set through external terminals. This parameter is used to set the increasing and decreasing speed of the frequency set by external terminal.

6.2 analog input output parameter group



The function parameter group [F1.00] ~ [F1.01] defines the upper and lower limit of external input signal as the frequency setting signal. E550 series inverters allow for inputting analog voltage signal and analog current signal; the analog current signal 0-20mA is corresponding to the voltage signal 0-10V.

F1.00 *AI input lower limiting voltage* **Setting range: 0.0V ~ [F1.01]**

F1.01 *AI input upper limiting voltage* **Setting range: [F1.00] ~ 10.0 V**

[F1.00] and [F1.01] defines AI range of analog input channel, which shall be set according to actual conditions of access signal.

F1.02 *AI input filter time* **Setting range: 0.01 ~ 1.00Sec**

When external analog input quantity is subject to filter processing to effectively eliminate interfering signals, if it is set to large value, the interfering capability is strong but it will slow down response speed to setting signals.

F1.03	Minimum set frequency	Setting range: 0.0Hz ~ [F1.04]
F1.04	Maximum set frequency	Setting range: [F1.03] ~ [F0.04]

The corresponding relationship between the analog input quantity and set frequency is shown in Figure 6-6.

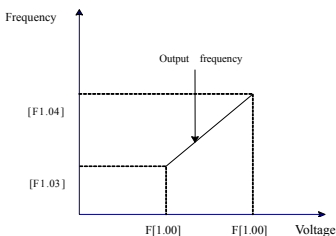

Figure 6-6 Corresponding relationship sketch of analog input quantity and set frequency

F1.05	Analog output selection	Setting range: 0 ~ 2
--------------	--------------------------------	-----------------------------

Select the meaning of analog output terminal AO (setting of fragile decimal system).

LED Units: Define meaning of analog output AO

0: output frequency

The analog output (AO) amplitude is proportional to the inverter's output frequency. The setting upper limit ([F1.07]) is corresponding to the upper limiting frequency.

1: output current

Analog output (AO) amplitude

It is proportional to the inverter's output current. The setting upper limit ([F1.07]) of the analog output is corresponding to two times of the inverter's rated current.

2: Output voltage

The analog output (AO) amplitude is proportional to the inverter's output voltage. And the setting upper limit ([F1.07]) of the analog output is corresponding to the maximum output voltage ([F0.13]).

F1.06	AO output lower limit	Setting range: 0.0 V ~ [F1.07]
F1.07	AO output upper limit	Setting range: [F1.06] ~ 10.0 V

Define the maximum value and minimum value of analog output AO output signal. Refer to figure 6-7.

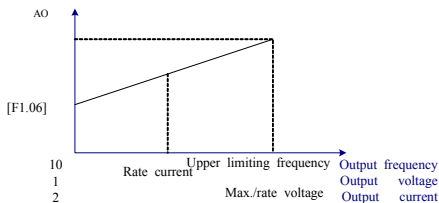

Figure 6-7 Analog output content of analog output terminal

F1.08	Function selection for input terminal 1	Setting range: 0 ~ 29
F1.09	Function selection for input terminal 2	Setting range: 0 ~ 29
F1.10	Function selection for input terminal 3	Setting range: 0 ~ 29
F1.11	Function selection for input terminal 4	Setting range: 0 ~ 29

Function definition of switch quantity input terminal X1~X4, which is described as below:

- 0: control terminal in idle**
- 1: Multi-speed control 1**
- 2: Multi-speed control 2**
- 3: Multi-speed control 3**

The combination of multi-speed control terminals can be used to select multi-speed output frequency. The frequency setting at each stage is to be determined by the multi-speed control parameter functional group ([F3.00]~[F3.06]).

- 4: FWD jog control**
- 5: REV jog control**

When the external terminal of running command channel selection is effective, this parameter can define the input terminal of external jog signals.

6: Frequency set channel selection 1**7: Frequency set channel selection 2**

When the frequency input channel is set to be external terminal selection (F0.00=4), the frequency set channel of the inverter will be determined by the status of these two terminals, and for its corresponding relationship, please refer to description of parameter [F0.00].

8: Free stop control

If terminal corresponding to this parameter is engaged, the inverter will lock output.

9: Three-line running control

When the running command terminal combination mode is set to three-line mode, the external terminal defined by this parameter is inverter stop trigger switch. See functional code [F0.02] for the three-line control mode in details.

10: DC braking control

At the inverter stop status, if the terminal defined by this parameter is engaged, when the output frequency is lower than the DC braking initial frequency, the DC braking function will be enabled until the terminal is disconnected. See description of [F2.03] ~ [F2.05] for relevant parameters of DC braking.

11: FWD control**12: REV control****13: Fault reset**

When the inverter is at the faulty status, engaging the terminal set by parameter can clear inverter's fault.

14: Reserve**15: Reserve****16: External fault input**

When the terminal set by this parameter is engaged, it indicates that the external equipment is faulty. At this time, in order to ensure safety of the equipment, the inverter will lock the input and displays the external fault signal Fu.16.

17: Disconnection input

When the terminal set by this parameter is engaged, it indicates disconnection fault of external equipments. At this time, in order to guarantee equipment safety, the inverter will lock output, and displays the external fault signal Fu.17.

18: PLC effective

When the programmable PLC running condition [F3.17] is selected to be effective, the external terminal defined by this parameter can enable effecting and cut-off of PLC operation.

19: Swing frequency running effective

When the swinging frequency function condition is selected to be effective ([F3.26]=XXX1), the external terminal defined by this parameter can enable effecting and cut-off of swing frequency running.

20: UP**21: DW**

The running frequency of the inverter can be set through external terminals, hence allowing for remote frequency setting. When the terminal is effective, the set frequency increases or decreases at set speed. When the terminal is void, the set frequency is maintained unchanged. When the two terminals are effective simultaneously, the set frequency is maintained unchanged. When the UP is effective, the frequency increases and when DW is effective, the frequency decreases.

22: Internal counting clock**23: Internal counting clock clearing****24: Reciprocating running effective****25: Terminal machine running battering effective****26: Reserve****27: Reserve****28: Splitting machine infrared signal****29: Splitting machine approaching switch signal**

F1.12 <i>Selection of input channel characteristics</i> Setting range: 0000~ 1111H
--

It is used to select characteristics of external digital input:

LED UNITS: Define characteristics of X1 input channel

0: positive characteristics 1: negative characteristics

LED Tens: Define characteristics of X2 input channel

0: positive characteristic 1: negative characteristic

LED Hundreds: Define characteristics of X3 input channel

0: positive characteristic 1: negative characteristic

LED Kilobits: Define characteristics of X4 input channel

0: positive characteristic 1: negative characteristic

The positive characteristic is effective when the terminal is engaged and void when the terminal is disconnected. The negative characteristic is effective when the terminal is disconnected and void when the terminal is engaged.

F1.13 Output terminal OC function selection Setting range: 0 ~ 15

F1.14 Relay output TA/TC function selection Setting range: 0 ~ 15

It is used to define the contents indicated by the collector open-circuit output terminal OC and relay output contact. See Figure 6-8 for the internal wiring diagram of the collector open-circuit output terminal. When the function is set to be effective, the output is at low level, and when the function is void, the output is at the high-resistance status.

Relay contact output: when the output function is set to be effective, the normally open contact TA-TC is connected.

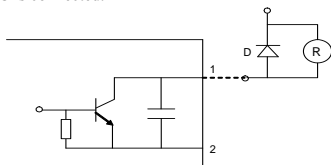

Figure 6-8 internal circuit of OC output terminal



For connecting external inductive elements (e.g. relay coil), freewheel diode D must be connected in parallel.

0: Inverter is running

When the inverter is running, it outputs effective signals, and when the inverter is at stop, it outputs void signals.

1: Frequency reaching

When the inverter's output frequency is approaching the set frequency within certain range (which is defined by parameter [F1.17]), it outputs effective signals, otherwise, it outputs void signals.

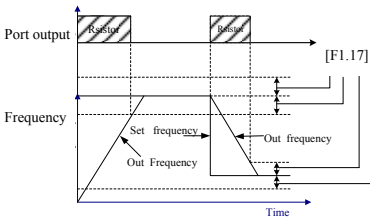

Figure 6-9 Frequency reaching signal

2: Frequency level detection (FDT)

When the inverter's output frequency exceeds FDT frequency level, after the set delay time, it outputs effective signals. When the inverter's output frequency is lower than the FDT frequency level, after the same delay time, it outputs void signals.

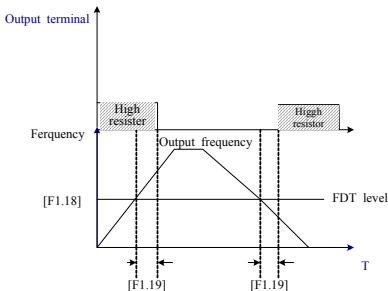

Figure 6-10 Frequency Level Detection Signal (FDT)

3: Overload detection

When the inverter's output current exceeds the overload alarm level, after the set alarm delay time, it outputs effective signals. When the inverter's output current is lower than the overload alarm level, after the same delay time, it outputs void signals.

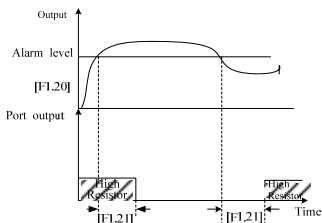

Figure 6-11 Overload Alarm

4: Frequency reaching upper limit

When the inverter's output frequency reaches the upper limiting frequency, this terminal outputs effective signals; otherwise, it outputs void signals.

5: Frequency reaching lower limiting

When the inverter's output frequency reaches the lower limiting frequency, this terminal outputs effective signals; otherwise, it outputs void signals.

6: Running at zero speed

When the inverter's running command is effective and the output frequency is at 0, this terminal outputs effective signals; otherwise, it outputs void signals.

7: Under voltage stop

When the inverter's DC side voltage is lower than the specified value, the inverter stops running, and this terminal outputs effective signals; otherwise, it outputs void signals.

8: Inverter fault

When the inverter stops running due to fault, it outputs effective signals; and when the inverter runs normally, it is at void status.

9: Disconnection fault

When the inverter stops running due to disconnection fault, it outputs effective

signals; and when the inverter runs normally, it is at void status.

10: PLC cycle completion

When the inverter stops running due to disconnection fault, it outputs effective signals; and when the inverter runs normally, it is at void status.

11: High-frequency output

When the output frequency reaches the set action frequency [F6.09], it outputs effective signals, and when the output frequency is lower than the disconnecting action frequency [F6.10], it outputs void signals.

12: Reaching specified count value

When the internal clock count reaches the specified count value [F1.25], it outputs effective signals, and outputs void signals when the next time of pulse is reaching.

13: Reaching final value cycle

When the internal clock count reaches the final count value [F1.26], it outputs effective signals, and outputs void signals when the next time of pulse is reaching.

14: Reserve

15: Reserve

F1. 15	OC and relay output characteristics	Setting range: 0000 ~ 0011
---------------	--	-----------------------------------

Select polarity of OC output and relay output according to digits. When it is set to “1”, the output polarity is reverse.

F1. 16	Relay action delay	Setting range: 0.0 ~ 5.0Sec
---------------	---------------------------	------------------------------------

This parameter is used to set the delay time for change of status of relay output signals

It is used to set the frequency reaching detection amplitude defined by the output terminal. When the inverter’s output frequency is within the positive and negative detection amplitude of the set frequency, the output terminal outputs effective signals.

Refer to Figure 6-9.

F1.18	FDT (frequency level) setting	Setting range: 0.0 ~ 1000 Hz
--------------	--------------------------------------	-------------------------------------

F1.19	FDT output delay time	Setting range: 0.0 ~ 5.0Sec
--------------	------------------------------	------------------------------------

This parameter group is used to set frequency detection level.

When the output frequency is higher than the FDT set value, after the set delay time, the output terminal outputs effective signals.

When the output frequency is lower than the FDT set value, after the same delay time, the output terminal outputs void signals.

F1.20	Overload alarm level	Setting range: 50 ~ 200 (%)
--------------	-----------------------------	------------------------------------

F1.21	Overload alarm delay time	Setting range: 0.0 ~ 60.0Sec
--------------	----------------------------------	-------------------------------------

This parameter is used to set the overload alarm level and alarm delay time. When the output current is higher than the set value of [F1.20], after the delay time set by [F1.21], the output terminal outputs effective signals (low level). Refer to figure 6-10.

F1.22	Reserve
--------------	----------------

F1.23	Reserve
--------------	----------------

F1.24	Batter number of terminal machine	Setting range: 1~100
--------------	--	-----------------------------

F1.25	Specified count value	Setting range: 1~[F1.26]
--------------	------------------------------	---------------------------------

F1.26	Initial count value	Setting range: [F1.25]~60000
--------------	----------------------------	-------------------------------------

F1.27	Reserve
--------------	----------------

F1.28	Frequency input channel combination	Setting range: 0~10
--------------	--	----------------------------

This parameter is only effective when the frequency input channel is set to combined setting.

The inverter's set frequency is determined by the liner combination of multiple

F2.02 Stop mode**Setting range: 0 ~ 1****0: Deceleration stop**

The inverter stops after its output frequency decreases gradually according to the set deceleration time.

1: Free stop

When stopping, the inverter outputs zero frequency and locks output signals, and the motor rotates freely and then stops. At the free stop, it is required to restart the motor after the motor has completed stopped running. Otherwise, over current or overvoltage fault may occur.

F2.03 DC braking initial frequency at stop **Setting range: 0.0 ~ [F0.04]**

F2.04 DC current at stop **Setting range: 0.0 ~ 100%**

F2.05 DC braking time at stop **Setting range: 0 ~20.0 Sec.**

This parameter group is used to set DC braking parameters at stop.

During the process of DC braking initial frequency ([F2.03]) at stop setting inverter stop, when the output frequency is lower than the set parameter, the inverter will lock output and enable DC braking function. The stop DC braking action time is to be set by parameter [F2.05]. The stop DC braking action time is set to 0, the stop DC braking function is ineffective.

Stop DC braking current means the percentage of inverter's rated current.

F2.06 Acceleration torque level**Setting range: 110 ~ 200 (%)**

This parameter is used to set the allowed output level of torque current at acceleration. The torque limiting level during inverter acceleration is set by [F2.06]. It is set to the percentage of inverter's rated current. For example, if it is set to 150%, it means the output current is 150% of the rated current at maximum.

When the inverter's output current is higher than the level specified by these parameters, the acceleration and deceleration time will be prolonged automatically so as to confine the output current within this level range. Refer to Figure 6-13.

Therefore, if the acceleration time is required to be shorter, acceleration torque level needs to be increased.

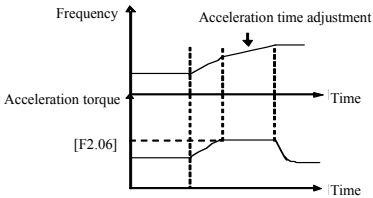

Figure 6-13 Sketch of acceleration torque and braking torque

F2.07 Motor overload protecting coefficient **Setting range: 50 ~ 110 (%)**

This parameter is used to set inverter's sensitivity of thermal relay protection for load motor. When the rated current of the load motor is not matching with the inverter's rated current, it is applicable to set this value to provide correct thermal protection over the motor. When it is set to 110%, the inverter will disable the motor overload protection function.

The set value of this parameter is determined by following formula.

$$[F2.07] = \frac{\text{Motor rated current}}{\text{Inverter rated output current}} \times 100\%$$



When one inverter and multiple motors run in parallel, the inverter's thermal relay protection function will be disabled. In order to effectively protect motors, it is suggested to install a thermal protecting relay at the inlet wire terminal for each motor.

F2.08 Dynamic braking initial voltage Setting range: 300~400V/600~800V

This parameter is effective for inverters with built-in braking unit and is used to define action parameters of inverter's built-in braking unit. When the inverter's internal DC side voltage is higher than dynamic braking initial voltage, the built-in braking unit acts. If external braking resistor is connected, the inverter's internal DC side pumping voltage energy will be released through the braking resistor so as to reduce the DC voltage. When the DC side voltage reduces to certain value ($[F2.08]-50V$), the inverter's built-in braking unit is closed, as shown in Figure 6-14.

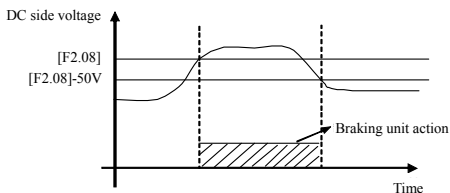

Figure 6-14 Dynamic Braking

F2.09 ~ F2.10 Reserve

F2.11	V/F frequency 1	Setting range: 0.0~[F2.13]
F2.12	V/F voltage 1	Setting range: 0.0~[F2.14]
F2.13	V/F frequency 2	Setting range: [F2.11]~[F2.15]
F2.14	V/F voltage 2	Setting range: [F2.12]~[F2.16]
F2.15	V/F frequency 3	Setting range: [F2.13]~[F0.12]
F2.16	V/F voltage 3	Setting range: [F2.14]~[F0.13]

This functional parameter group is used to flexibly set user desired V/F curve. See figure 6-15.

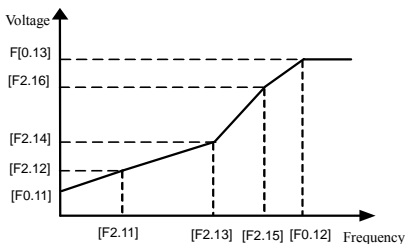

Figure 6-15 Setting of V/F Customized Curve

F2.17	Reserve
--------------	----------------

F2.18	Automatic voltage regulation	Setting range: 0~2
--------------	-------------------------------------	---------------------------

The automatic voltage regulation function is for protecting inverter's voltage from fluctuating with input voltage fluctuation. When the grid voltage varies greatly and it desired that the motor has comparatively stable stator voltage and current, this function should be enabled.

0:Void

1:Effective

2: Deceleration void

F2.19	Pairs of motor polarity	Setting range: 1~16
--------------	--------------------------------	----------------------------

This parameter is mainly used to calculate motor revolution.

F2.20~F2.21	Reserve
--------------------	----------------

6.4 Multi-speed and senior running parameter group

F3.00	Multi-speed frequency 1	Setting range: 0.0Hz ~ Upper limiting frequency
F3.01	Multi-speed frequency 2	Setting range: 0.0Hz ~ Upper limiting frequency
F3.02	Multi-speed frequency 3	Setting range: 0.0Hz ~ Upper limiting frequency
F3.03	Multi-speed frequency 4	Setting range: 0.0Hz ~ Upper limiting frequency
F3.04	Multi-speed frequency 5	Setting range: 0.0Hz ~ Upper limiting frequency
F3.05	Multi-speed frequency 6	Setting range: 0.0Hz ~ Upper limiting frequency
F3.06	Multi-speed frequency 7	Setting range: 0.0Hz ~ Upper limiting frequency

It is to set terminals with this parameter function code to control multi-speed running output frequency.

F3.07	Liner speed coefficient setting	Setting range: 0.01 ~ 100.00
--------------	--	-------------------------------------

This parameter is used to set the running liner speed and display value of liner speed. It can be also used to display other physical quantity proportional to output frequency.

Running liner speed (d-8) = F3.07 X Output frequency (d-0)
Set liner speed (d-9) = F3.07 X Set frequency (d-6)

F3.08	Monitoring parameter selection	Setting range: 0 ~ 22
--------------	---------------------------------------	------------------------------

This parameter is used to determine the display contents on the operating panel at the monitoring status.

The monitoring parameter selection is used to determine the display content on the LED.

The physical quantity corresponding to the display data can be referred to the status monitoring parameter table.

F3.09 Parameter inquiry and modification authority Setting range: 0 ~ 9999

This parameter is the check code for obtaining authority of inquiring and modifying some internal parameters.

F3.10 Parameter initialization Setting range: 0 ~ 9

It is used to change inverter's parameters into default value.

0: No action

1: Standard initialization: (All parameters in F0~F6 except F0.00, F0.02, F0.05, F0.06, F0.08, F0.11, F0.13 and F3.14 are restored to the default settings)

2: Clearing fault records

3: Complete initialization: (all parameters in F0~F6 group except for F3.14 is restored to default settings and fault records are cleared).

F3.11 Under voltage protection level Setting range: 180 ~230V/360 ~460V

This parameter specifies allowable lower limiting voltage at the DC side when the inverter works normally. For some occasions with low grid, it is applicable to appropriately reduce under voltage protection level so as to ensure normal operation of the inverter.

Note: when the grid voltage is too low, the motor's output torque will reduce. For occasions with constant power load and constant torque load, excessive low grid voltage will cause increase of inverter input current, hence leading to reduction of inverter operation reliability.

F3.12 Overvoltage limiting action level Setting range: 350 ~400V/700 ~800V

This parameter specifies the threshold value of voltage stall protection during motor deceleration. When the pumping voltage at the internal DC side of the Inverter caused by deceleration has exceeded this value, the deceleration time will be automatically prolonged. See figure 6-16.

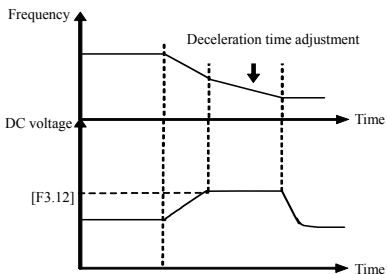

Figure 6-16 Voltage Stall Protection during Deceleration

F3.13	Current amplitude limiting level	Setting range: 150 ~ 250(%)
--------------	---	------------------------------------

This parameter specifies maximum current allowed to be output by the inverter, which is expressed by the percentage of rated current of the inverter. No matter what working status (acceleration, deceleration and steady running) the inverter is at, when the inverter's output current exceeds the value specified by this parameter, the inverter will adjust the output frequency to control the current within the specified range to avoid over current tripping.

Inverter's control software version number is read only.

F3.15 ~F3.16	Reserve
---------------------	----------------

F3.17	Multi-speed running mode	Setting range: 0000~0042H
--------------	---------------------------------	----------------------------------

Setting of basic characteristics of multi-speed running (fratile decimal system settin setting)

LED UNITS: Simple PLC action selection

0: Simple PLC void

1: Simple PLC effective

2: Simple PLC conditionally effective

When LED Units is selected to 1 (PLC effective), after the inverter has started, at the frequency channel priority allowed status, the inverter will enter the simple PLC running status.

When the LED Units is selected to 2 (PLC conditionally effective), when external PLC input terminal is effective(PLC input terminal is selected by parameter [F1.08] ~[F1.11]), the inverter will run at the simple PLC mode; when the external input terminal is void, the inverter will automatically enter the frequency setting mode with lower priority.

LED Tens: Selection of simple PLC running mode

0: Single cycle mode

The inverter will firstly runs at the set frequency of the first-section speed, and outputs frequency at each speed according to setting time. If the set running time is 0 at certain section of speed, it will skip over this speed section. The inverter will stop output after end of one cycle, and will not start the next cycle unless the effective running command is input again.

1: Single cycle stop mode

The basic running way is the same as the mode 0, and the difference is that the inverter firstly reduces the output frequency to 0 according to the specified acceleration time after completion of running at certain speed, and then outputs the next section of frequency.

2: Mode of keeping final value

The basic running way is the same as the mode 0. After the completion of the single cycle, the inverter will not stop after completion of a single cycle and continues running at the last speed for which the time is not set to zero. Other process is the same as model 1.

3: Keeping setting value mode

The basic running way is the same as the mode 0. After the completion of the single cycle, the inverter will not stop after completion of a single cycle and continues running at the last speed for which the time is not set to zero. Other process is the same as model 1.

F3.23 PLC running timer**Setting range: 0 ~9999Min**

When programmable multi-speed running function is selected, this parameter can be used to set programmable multi-speed running time. When the set time is reached, it will automatically stop. For restoring running, it is required to input stop command before the start command.

When this parameter is set to 0, timed running stop is void.

F3.24 Fault self-recovery times**Setting range: 0~5****F3.25 Fault self-recovery time****Setting range: 0.0~60.0Sec**

During running of the inverter, load fluctuation, grid fluctuation and other accidental factors may cause accidental shutdown of the inverter. At this time, in order to ensure system's working continuity, the inverter can be allowed to make automatic resetting for some kinds of faults and restore running.

The self-recovery interval means the interval from the fault start to the self-recovery. If the inverter cannot restore to normal condition within the set self-recovery times, it will output fault signal. After successful self-recovery, the inverter is at stop and ready status.

F3.26 Swing frequency running setting**Setting range: 0000~0012H**

This parameter is used to set basic characteristics of swing frequency running (fratle decimal system setting)

LED Units: Swing frequency function enabling selection

0: Swing frequency function disabled

1: Swing frequency function effective

2: Swing frequency function conditionally effective

When the external swing frequency input terminal is effective (the swing frequency input terminal is selected by functional parameter [F1.08]~[F1.11]), the inverter runs in swing frequency mode.

LED Tens: Center frequency setting

0: digital setting, [F3.31] setting

1: Frequency channel selection is set by frequency channel.

F3.27 Swing frequency amplitude**Setting range: 0.0~50.0%**

Swing frequency amplitude is the ratio of swing frequency extent.

Swing frequency amplitude=[F3.27]×Upper limiting frequency

F3.28 Kick frequency amplitude**Setting range: 0.0~80.0%**

The kick frequency is the amplitude of rapid descending after the frequency reaches the upper limit of swing frequency and is also the amplitude of rapid ascending after the frequency reaches the lower limit frequency.

Kick frequency =[F3.28] × Swing frequency amplitude

F3.29 Triangular wave descending time**Setting range: 0.1~300.0Sec****F3.30 Triangular wave ascending time****Setting range: 0.1~300.0Sec**

When the triangular wave descending time is the running time from the swing frequency upper limit to swing frequency lower limit during running at the swing frequency, i.e. the deceleration time during running cycle at swing frequency.

When the triangular wave ascending time is the running time from the swing frequency lower limit to swing frequency upper limit during running at the swing frequency, i.e. the acceleration time during running cycle at swing frequency.

F3.31 Swing frequency center frequency setting Setting range: 0.0~[F0.04]

Swing frequency center frequency means the center value of inverter's output frequency at the swing frequency running status.

See Figure 6-17 for detailed process of swing frequency running

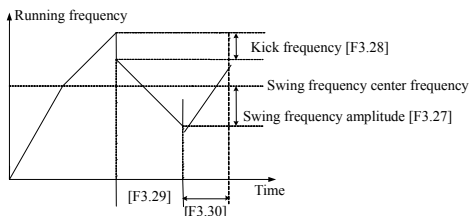

Figure 6-17 Swing Frequency Running Process

6.5 Communication functional parameter group

F4.00 Communication setting
Setting range: 0000 ~ 0125

This parameter is used to set characteristics relevant with communication (fratile decimal system setting)

LED Units: Baud rate selection

- | | | |
|------------|------------|-------------|
| 0: Reserve | 1: 1200bps | 2: 2400bps |
| 3: 4800bps | 4: 9600bps | 5: 19200bps |

When serial port communication is adopted, the communication parties must have the same baud rate.

LED Tens: Data format selection

- | | | |
|-------------|---------------|--------------|
| 0: No check | 1: Even check | 2: Odd check |
|-------------|---------------|--------------|

When serial port communication is adopted, the communication parties must have the same baud rate.

LED Hundreds: Protocol selection

- | | |
|-------------------|----------------------------------|
| 0: RS485 protocol | 1: MODBUS communication protocol |
|-------------------|----------------------------------|

LED Kilobit: Reserve

F4.01 Local address**Setting range: 0 ~ 30**

The local address set for communication of this inverter is only effective when this inverter is used as the slave machine. During communication, this inverter only sends back response frame for data frames corresponding to the local address, and receives command.

With the SUNFAR self-defined protocol, the address 31 is the broadcasting address, and 0 represents the broadcasting address in the case of MODBUS communication. For broadcasting data, the slave machine executes command but does not give feedback of corresponding data (see the appendix of communication protocol).

F4.02 Local response delay**Setting range: 0 ~ 1000 ms**

The waiting time till sending response data frame after the local inverter has correctly received information code of the upper computer.

F4.03 Setting of communication auxiliary function **Setting range: 0000 ~ 0011****LED UNITS: Main and slave inverter setting**

0: This inverter is the main inverter 1: This inverter is a slave inverter

When multiple inverters requires linkage synchronous control, one of inverters should be set as the main inverter.

LED Tens: Action selection after communication failure

0: Shutdown 1: Maintaining current status

LED Hundreds: Data return selection

0: Normal return of data 1: Do not return data

LED Kilobit: Reserve

F4.04 Communication overtime detection time Setting range: 0.1 ~ 10.0 Sec

When this inverter has not received correct data signal beyond the interval defined by this parameter, it is judged that the inverter has subject to communication failure. Then, it is applicable to select shutdown or continuing running according to the work mode after communication failure set by [F4.03].

F4.05 Linkage setting ratio
Setting range: 0.1 ~ 10.0

This parameter defines the ratio of main machine and slave machine output frequency at the mode of linkage control.

This group parameter of the main inverter does not function. When linkage synchronous control trough RS485 port is achieved, the running command of the slave inverter is completely synchronous with the main machine. The frequency command of the slave machine is calculated according to following method:

Slave inverter frequency command = Main inverter frequency command \times [F4.05]

6.6 PID parameter group

PID control is subject to calculation of ratio, integral and differential according to the difference between the feedback value the controlled system and the target value, so as to adjust the inverter's output frequency and maintain the controlled system stable with the target signals. The principle is shown in Figure 6-18.

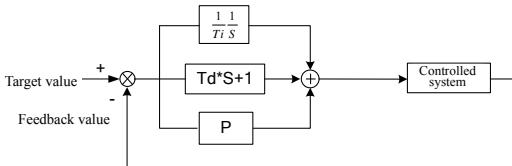

Figure 6-18 PID Function Sketch

F5.00 PID function selection**Setting range: 0 ~ 1**

0: PID function disabled

1: PID function enabled

F5.01 PID setting channel**Setting range: 0 ~ 1**

It is used to select the setting channel of the PID target value.

0: Digital setting by [F5.02]

1: frequency input channel setting

PID's set target value is a relative value. The setting 100% is corresponding to 100% of feedback system of the controlled system.

F5.02 PID digital setting**Setting range: 0.0~100.0%**

The base value of this parameter is the system's maximum feedback signal.

F5.03 PID feed forward enabling**Setting range: 0000~0001H**

0: Feed forward function disabled

1: Feed forward function enabled

System's response speed at start can be increased.

F5.04 Reserve**F5.06 Ratio grain****Setting range: 0.0~10.0****F5.07 Integral time****Setting range: 0.01~10.00Sec****F5.08 Derivative time****Setting range: 0.00~10.00Sec**

It is parameter group of inner PID controlled.

F5.09 PID adjustment frequency range**Setting range: 0 ~ 100%**

This parameter is used to set the upper limit frequency to be a adjusted by PID, which is the percentage of maximum output frequency corresponding to the maximum PID value.

F5.10	Breakage detection lower limiting value	Setting range: 0.0 ~50.0%
F5.11	Breakage detection delay time	Setting range: 0.1 ~10.0Sec

If the system's feedback value is less than the breakage detection lower limiting value, it is deemed that the system is at the break ge status and the system starts detecting breakage. After the delay time, if the system is still at the breakage status, then it is deemed that there is a breakage fault.

6.7 Special machine parameter group

F6.00	Cutting function selection	Setting range: 0000~0001H
--------------	-----------------------------------	----------------------------------

This parameter is used to select if this inverter is used for cutter dragging or cutting control.

0: As the dragging control

1: As the cutting control

F6.01	Cutting length	Setting range:: 0.01~10.00
F6.02	Correction of liner speed coefficient	Setting range: 0.01~10.00

This group of parameters is effective for cutting control. The cutting length is the set value of required wood length in the unit of meter. [F6.02] parameter is used for length correction which will be done according to mechanical characteristics.

F6.03	Start delay	Setting range:: 0.01~10.00
F6.04	Stop delay	Setting range: 0.01~10.00

This group of parameters defines the cutting start delay and stop delay, which is related to the length of the first plate and last plate.

F6.05	Reserve
--------------	----------------

F6.06 Liner cutting running mode**Setting range: 0 ~2**

This parameter is used to select if it is needed to enable liner cutter function.

0: Disable cutter function

1: Liner cutter mode 1 (this mode is applicable to high-speed wire mode)

2: Liner cutter mode 2 (this mode is applicable to the medium-speed wire mode)

F6.07 Forward time**Setting range: 0~60.0Sec****F6.08 Return time****Setting range: 0~60.0Sec**

This group of parameters defines the forward and backward time in the next cycle in the reciprocating mode.

F6.09 High-frequency relay start frequency**Setting range: [F6.10]~100%****F6.10 High-frequency relay disconnection frequency 1****Setting range: 0~[F6.09]****F6.11 High-frequency relay disconnection frequency 2****Setting range: 100~200%**

This group of parameters is used to set the conditions for engaging or disengaging high-frequency relay.

When the inverter's output frequency is higher than the frequency set by [F6.09]*, the high-frequency relay is engaged. When it is lower than the frequency set by [F6.10], the high-frequency relay is disengaged. In the liner cutting mode 2, when the inverter's output frequency is higher than frequency set by [F6.11], the high-frequency relay is disengaged.

7 Fault Diagnosis And Countermeasures

7.1 Protection function and countermeasures

Fault Code	Fault Description	Possible Reasons	Solutions
Fu.01	Over current occurs in inverter acceleration running process	<ol style="list-style-type: none"> 1. The acceleration time is too short. 2. Start the rotating motor directly. 3. The torque boost is preset as too large. 4. The network voltage is too low. 	<ol style="list-style-type: none"> 1. Extend acceleration time. 2. Restart the motor after stop 3. Reduce voltage of torque boost. 4. Check the network voltage and reduce power.
Fu.02	Over current occurs in inverter deceleration running process	The acceleration time is too short.	Increase the acceleration time
Fu.03	Over current occurs in inverter running or stop condition	<ol style="list-style-type: none"> 1. Load changes suddenly 2. The network voltage is too low. 	<ol style="list-style-type: none"> 1. Reduce the load fluctuation. 2. Check the power voltage.
Fu.04	Overvoltage occurs in inverter acceleration running process	<ol style="list-style-type: none"> 1. The input voltage is too high. 2. Put the power on and off frequently. 	<ol style="list-style-type: none"> 1. Check the power. 2. Lower the setting of acceleration torque level.
Fu.05	Overvoltage occurs in inverter deceleration running process	<ol style="list-style-type: none"> 1. The acceleration time is too short. 2. The input voltage is abnormal. 	<ol style="list-style-type: none"> 1. Extend the acceleration time. 2. Check the power voltage. 3. Install braking resistor or reselect braking resistor.
Fu.06	Overvoltage occurs in inverter running process	<ol style="list-style-type: none"> 1. The power voltage is abnormal. 2. There is energy feedback load. 	<ol style="list-style-type: none"> 1. Check the power voltage. 2. Install the braking unit and braking resistor or reselect braking resistor.
Fu.07	Overvoltage occurs in inverter stop condition	The power voltage is abnormal.	Check the power voltage.
Fu.08	Under-voltage occurs in inverter running process	<ol style="list-style-type: none"> 1. The power voltage is abnormal. 2. There is starting operation of heavy load in network. 	<ol style="list-style-type: none"> 1. Check the power voltage. 2. Supply power separately.
Fu.09 ~Fu.11	Reserve		
Fu.12	Inverter overload	<ol style="list-style-type: none"> 1. The load is too large. 2. The acceleration time is too short. 3. The torque boost is too high. 4. The network voltage is too low. 	<ol style="list-style-type: none"> 1. Reduce load or change a larger capacity inverter. 2. Extend the acceleration time. 3. Reduce the voltage of torque boost. 4. Check the network voltage.
Fu.13	Motor overload	<ol style="list-style-type: none"> 1. The load is too large. 2. The acceleration time is too short. 3. The protection factor setting is too small. 4. The torque boost is too 	<ol style="list-style-type: none"> 1. Reduce load. 2. Extend the acceleration time. 3. Increase the overload protection factor of motor. 4. Reduce torque boost.

Fault Code	Fault Description	Possible Reasons	Solutions
		high.	
Fu.14	Inverter overheat	1. Air duct obstruction 2. The environment temperature is too high. 3. The fan is damaged.	1. Clean air duct or improve ventilation condition. 2. Improve the ventilation condition and reduce the carrier frequency. 3. Change fan.
Fu.15	Reserve		
Fu.16	External equipment fault	The exterior fault input terminal is ineffective.	1. Check the exterior equipment. 2. Disconnect the external fault input terminal.
Fu.17 ~Fu.19	Reserve		
Fu.20	Current detection error	The current detection devices or circuit is damaged.	1. Check socket line. 2. Ask for manufacturers' assistance.
Fu.21	Temperature sensor fault	The temperature sensor is off-line.	1. Check socket line. 2. Ask for manufacturers' assistance.
Fu.22	Reserve		
Fu.23	PID feedback off-line	1 The feedback signal is lost. 2. The setting of off-line detection threshold value is not appropriate.	1. Check line. 2. Reduce threshold value of off-line detection.
Fu.24 ~Fu.39	Reserve		
Fu.40	Internal data EEPROM error	The read-write errors of control parameters	Ask for manufacturers' assistance.

7.2 Fault record query

The series of inverters recorded the recent fault code occurred in the last four times and the inverter output parameters of the last fault; query of these information will contribute to find fault causes.

Monitoring project	content	Monitoring project	content
d-23	The first fault record	d-28	The output current of the last fault recently
d-24	The second fault record	d-29	The output voltage of the last fault recently
d-25	The third fault record	d-30	The direct voltage of the last fault recently

Monitoring project	content	Monitoring project	content
d-26	The fourth fault record	d-31	The module temperature of the last fault recently
d-27	The output frequency of the last fault recently		

The fault information and condition monitoring parameters are stored in a unified manner; please refer to the keyboard operation method to query information.

7.3 Fault reset



- The fault causes must be identified and removed completely prior to reset, otherwise it may cause permanent damage to the inverter.
- If the inverter can't be reset or fault occurs after reset, it's necessary to find out causes, otherwise continuous reset will damage the inverter.
- The protection actions of overload and overheat should be delayed for 5 minutes when reset.

To recover to the normal operation when the inverter fault occurs, it's optional to choose any of the following operations.

Method I: Press  key when displaying fault code.

Method II: Disconnect after closure of external multi-function terminals X1~X4 (fault reset) and CM.

Method III: Send the fault reset command via RS485 interface.

Method IV: Cut off power supply.

Appendix I: SUNFAR Self-defined Communication Protocol

1.1 Overview

E550 model provides standard RS485 communication port, so users can realize centralized monitoring (send running command, set inverter running parameters and read inverter working status) by PC/PLC to meet specific application requirements. The protocol content of the appendix is designed to achieve the above functions.

1.1.1 Protocol Content

The serial communication protocol defines the transmitted information content and applicable format in the serial communication protocol, including: main machine polling (or broadcast) format; main machine encoding method; the content includes the function code of the required action, data transmission and error checking, etc. The slave machine response also employs the same structure; the content includes action confirmation, feedback data and error checking, etc. If slave machine goes wrong or fails to complete the required actions of man machine when receiving information, a fault message will be organized and sent to the main machine as response.

1.1.2 Application Scope

1. Applicable products

The series of SUNFAR inverters, e.g. C300 series, C320 series, the E550 series, E380 series, etc. can be compatible with the communication protocols of the other brands of inverters.

2. Applicable methods

- (1) Inverter is accessed to the PC/PLC control network with “One main machine and multiple slave machines” and RS485 bus.
- (2) Inverter is accessed to the "Point-to-point" PC/PL monitoring background furnished with RS485 / RS232 interface (conversion interface).

1.2 Bus Structure and Protocol Specification

1.2.1 Bus Structure

1. Physical layer

Standard RS485 bus.

2. Transmission mode

Asynchronous serial and half-duplex transmission mode. Either main machine or slave machine can send data at the same time, while the other one can receive data only. The data will be sent frame by frame in message format in the process of serial asynchronous communication.

3. Topology mode

Single main station system is compatible with 32 stations at most with one station for main machine and the other 31 stations for slave machine. The setting range of slave address is 0-30, while 31(1FH) is the broadcast communication address. The slave address must be unique in the network. In fact, point-to-point mode is identified as special applications case of topology mode with “One main machine and multiple slave machines”, namely the condition of existing only one slave machine.

1.2.2 Protocol Specification

E550 series is applicable to MODBUS (please refer to Appendix II for details) and SUNFAR custom communication protocol, which is to be described as follows: SUNFAR custom communication protocol is a serial master-slave communication protocol, only one device (main machine) in the network can set up protocol (named as query/command), while the other devices (slave machine) can provide data to response query/command of main machine or operate the corresponding actions in line with query/command of main machine. Here, main machine refers to personal computer (PC), industrial personal computer (IPC) or programmable logic controller (PLC), etc., while slave machine refers to the inverter. Main machine can separately access some slave machine and send broadcast message to all slave machine. As for query/command for separate access sent by main machine, slave machine should feedback one message (named as response); as for broadcast

message sent by main machine, it's not necessary for slave machine to make any feed- back to main machine.

1. Communication setting

F4.00=X0XX, select SUNFAR custom communication protocol.

2. Data structure

Available in three types of data transmission formats:

- (1) 1-bit start bit, 8-bit data bit, 1-bit stop bit, no check.
- (2) 1-bit start bit, 8-bit data bit, 1-bit stop bit, even parity check (factory settings).
- (3) 1-bit start bit, 8-bit data bit, 1-bit stop bit, odd parity check.

3. Baud rate

Available in five types of Baud rates: 1200bps, 2400 bps, 4800 bps, 9600 bps, 19200 bps.

4. Communication mode

- (1) Adopt point-to-point communication mode with main machine for polling and slave machine for response.
- (2) Employ inverter keyboard to set up inverter serial interface communication parameters, including local address, Baud rate and data format.



The main machine must be preset with the same Baud rate and data format with the inverter.

5. Communication rules

- (1) More than 5 bytes of start interval time between data frames should be guaranteed and only messages in compliance with the specified start interval time is valid after being identified.
- (2) The main machine connection waiting time and maximum response time of inverter are 8 bytes transmission time; if timeout occurs, it will be determined as communication fault.
- (3) If the inverter fails to receive any message after detecting time from communication timeout (function code: F4.04), it's identified as off-line fault, and

then the inverter determines operating status of slave machine in line with setting content set by communication aid function (function code: F4.03). (In case of receiving message from main station in the period, it's necessary to make control based on control word of new message).

1.2.3 Message structure

The frame size of each message is between 11 and 18 bytes (depend on data format) and the character type can be ASC II code and hexadecimal value.

Data representation rules: hexadecimal, high-order first and then low-order, shown as below:

(1) The ASC II code of data 3800H is expressed as the following:

Data location	9	10	11	12
	Setting Data	Setting Data	Setting Data	Setting Data
Data value (hexadecimal)	33	38	30	30

(2) The hexadecimal value of data 3800H is expressed as the following (invalid bit is filled with hexadecimal "0"):

Data location	9	10	11	12
	Setting Data	Setting Data	Setting Data	Setting Data
Data value (hexadecimal)	00	00	38	00

1. Command frame of main machine

Sending sequence	0	1	2	3	4	5	6	7	8	9	10	11	12	13	14	15	16	17
	Frame header																	
Define	Slave address	Slave address	Slave address classification	Command	Operation command	Operation command	Data	Data address	Data address	Setting Data	Setting Data	Setting Data	Setting Data	Checksum	Checksum	Checksum	Checksum	Checksum
	Station address	Command area			Address area			Data area				Check area			0DH			

2. Response frame of slave machine

General description of data definition in data frame

Sending sequence	0	1	2	3	4	5	6	7	8	9	10	11	12	13	14	15	16	17
	Frame header																	
Define	Slave address	Slave address	Slave machine response	Status feedback	Status feedback	Data classification	Data address	Data address	Running data	Running data	Running data	Running data	Checksum	Checksum	Checksum	Checksum	Checksum	Checksum
	Station address	Response area			Address area		Data area			Check area			0DH					

(1) Frame header

The communication protocol specifies that “2AH” (refers to ASC II code of character “*”) and “5AH” are valid frame header. When frame header is “2AH”, all data following frame header is default as ASC II character; when frame header is “5AH”, all data following frame header is default as hexadecimal value and the redundant invalid bytes are filled with “0”. Independent “2AH” or “5AH” cannot be identified as valid frame header, a waiting time of more than 5 transmission bytes must be guaranteed in advance, which is considered as the starting condition of forming one frame data.

(2) Slave address

The setting range of inverter local address is 0~30 and 31(1FH) is broadcast communication address.

(3) Command classification

Command classification exists in the data frame sent by main machine, which is used to define tasks of the frame data to be completed. Frame size varies based on different command classification. Command classification is defined as below:

Data	Operation
0	Read status and feature information of slave machine
1	Read running parameters of slave machine
2	Read function code parameters
3	Modify function code parameters in inverter RAM area and to be lost after power down (Not to be saved)
4	Send control command
5	Modify function code parameters in inverter EPROM area and to be saved after power down
6~F	Reserve

(4) Operation command

The upper machine transmits operation command to slave machine, which exists in all types of data frame (main machine send the 4th and 5th bit). The operation command is defined as below:

Data	Operation	Data	Operation
00H	Invalid command	10H	Set running frequency of slave machine
01H	FWD running start	11H	Frequency setting of tape running in FWD running start
02H	REV running start	12H	Frequency setting of tape running in REV running start
03H	Stop	13H	Frequency setting of tape running in stop condition
⋮	⋮	⋮	⋮
20H	Fault reset of slave machine	30H	Reserve
21H	Emergent stop of slave machine	31H	Reserve



If don't need to send operation command, please send invalid command "00H".

(5) Slave machine response

The response of slave machine to data sent by main machine is mainly used to feedback implementation of slave machine to command frame of main machine, which exists in all types of data frame. The slave machine response is defined as below:

Data	Meaning	Data	Meaning
0	Slave machine receives data, normal operation	1	The received data range is over ranging
2	Slave machine running forbids modifying data	3	Data modification is forbidden by password
4	Try to read-write reserve/hidden parameters	5	Reserve
6	The specified parameter code or address are illegal (over ranging)	7	When transmitting data in ASC II code, illegal ASC II character exists.
8	Illegal command classification or operation command	9~F	Reserve



When the data of response byte of slave machine is "6-8", the response frame size is 11 bytes.

The frame format is shown as below:

Slave machine response	0	1	2	3	4	5	6	7	8	9	10
	Frame header	Slave address	Slave address	Slave machine response	0	0	Checksum	Checksum	Checksum	Checksum	Checksum
Definition	Station address		Command / Response area			Check area				0DH	

(6) Status feedback

The basic running status of slave machine responded from slave machine to main machine exists in all types of data frame (Slave machine responds the 4th and 5th bit).

Data	Operation	Data	Operation
00H	The direct voltage of slave machine is not ready	10H	Reserve
01H	In FWD running of slave machine	11H	In FWD acceleration process
02H	In REV running of slave machine	12H	In REV acceleration process
03H	Slave machine stop	13H	Instant stop and restart
04H	In FWD inching running of slave machine	14H	FWD deceleration
05H	In REV inching running of slave machine	15H	REV deceleration
06H	Reserve	16H	The slave machine is in DC braking status
20H	The slave machine is in fault status	21H	Instant stop of slave machine

(7) Checksum

The sum of ASC II code value (ASC II code format)/hexadecimal value from slave address to setting data/running data.

(8) Frame end

Hexadecimal "0DH" is ASC II code of "CR".



When the slave machine is in fault status, namely status feedback data is "20H", the 7th and 8th data (data address) of feedback data frame represents fault code.

1.3 Description of frame format



When frame header, frame end and checksum in data frame sent by main machine are abnormal, slave machine possibly fails to make normal response.

1.3.1 Command classification 0- Read status and feature information of slave machine

Main machine sending frame size is 14 bytes, while slave machine response frame size is 18 types.

Sent by main machine	0	1	2	3	4	5	6	7	8	9	10	11	12	13
	Frame header	Slave address	Slave address	0	Operation command	Operation command	Data classification	0	0	Checksum	Checksum	Checksum	Checksum	Frame end

Slave machine response	0	1	2	3	4	5	6	7	8	9	10	11	12	13	14	15	16	17
	Frame header	Slave address	Slave address	Slave machine response	Status feedback	Status feedback	Data classification	Feature information	Feature information	Feature information	Feature information	Feature information	Feature information	Checksum	Checksum	Checksum	Checksum	Frame end

Note: In accordance with different data classification value in the frame sent by main machine, the slave machine will feedback different feature information.

Data classification (Sent by main machine)		Feature information (Slave machine response)					
6		7	8	9	10	11	12
0	Read model information of slave machine	Voltage class	0	Power	Power	Power	Power
1	Read series information of slave machine	Reserve	Reserve	Reserve	Reserve	Reserve	Reserve
2	Read program version of slave machine	Reserve	Reserve	#	#	#	#

Data classification (Sent by main machine)		Feature information (Slave machine response)					
6		7	8	9	10	11	12
3	Read operation information of slave machine	Main machine control	Main machine frequency setting	Reserve	Reserve	Reserve	Reserve
4 ~ F	Reserve	#	#	#	#	#	#

For example: If the data classification value in the frame sent by main machine is 0, the feedback information of slave machine is 400015, which means that 4 represents voltage class – 380V; 0 is feature information value; 0015 represents power–1.5kw.

1.3.2 Command classification 1- Read running parameters of slave machine

Main machine sending frame size is 14 bytes, while slave machine response frame size is 18 types.

Sent by main machine	0	1	2	3	4	5	6	7	8	9	10	11	12	13
		Frame header	Slave address	Slave address	1	Operation command	Operation command	0	Data subitem	Data subitem	Checksum	Checksum	Checksum	Checksum

Slave machine response	0	1	2	3	4	5	6	7	8	9	10	11	12	13	14	15	16	17
		Frame header	Slave address	Slave address	Slave machine response	Slave machine feedback	Status feedback	0	Data subitem	Data subitem	Running data	Running data	Running data	Running data	Checksum	Checksum	Checksum	Checksum

Data subitem: is corresponding to number of monitoring parameter items of the inverter; as for E550 series inverter, the number of monitoring parameter items is shown as below:

Monitoring item	Data subitem	Slave machine response data
d.0	00	output frequency
d.1	01	output voltage
:	:	:
:	:	:
d-31	31	The module temperature of the last fault recently



The monitoring parameter of inverter refers to Chapter 4 of E550 series inverter operation manual: Article 4.3 List of status monitoring parameter.

1.3.3 Command classification 2- Read function code parameters

Main machine sending frame size is 14 bytes, while slave machine response frame size is 18 bytes.

	0	1	2	3	4	5	6	7	8	9	10	11	12	13
Sent by main machine	Frame header	Slave address	Slave address	2	Operation command	Operation command	Data classification	Data address	Data address	Checksum	Checksum	Checksum	Checksum	Frame end

	0	1	2	3	4	5	6	7	8	9	10	11	12	13	14	15	16	17
Slave machine response	Frame header	Slave address	Slave address	Slave machine response	Status feedback	Status feedback	Data classification	Data address	Data address	Parameter data	Parameter data	Parameter data	Parameter data	Checksum	Checksum	Checksum	Checksum	Frame end



The data classification and data address refer to command classification 3 and 5.

1.3.4 Command classification 3- Modify function code parameters in inverter RAM area.

1.3.5 Command classification 5- Modify function code parameters in inverter EPROM area

Main machine sending frame size is 18 bytes, while slave machine response frame size is 18 bytes.

Sent by main machine	0	1	2	3	4	5	6	7	8	9	10	11	12	13	14	15	16	17
	Frame header	Slave address	Slave address	3 or 5	Operation command	Operation command	Data classification	Data address	Data address	Setting Data	setting Data	Setting data	Setting data	Checksum	Checksum	Checksum	Checksum	Frame end

Slave machine response	0	1	2	3	4	5	6	7	8	9	10	11	12	13	14	15	16	17
	Frame header	Slave address	Slave address	Slave machine response	Status feedback	Status feedback	Data classification	Data address	Data address	Setting data	Setting data	Setting data	Setting data	Checksum	Checksum	Checksum	Checksum	Frame end

Definition of data classification:

Function code block	F0	F1	F2	F3	F4	F5	F6	F7	F8	F9	FC	FE	FF	FH	FL	FP		
Data classification	0	1	2	3	4	5	6	7	8	9	A	B	C	D	E	F		

The relative address of function code, e.g. the data address of F0.08, F1.08, F2.08 and F#.08 is 8, but data classification varies.

Note: When slave machine fails to complete main machine command, the feedback setting data is 0000.

1.3.6 Command classification 4- Send control command

Main machine sending frame size is 15 bytes, while slave machine response frame size is 18 types. In normal operation of inverter, the type of frame data is applicable to maximum extent.

Sent by main machine	0	1	2	3	4	5	6	7	8	9	10	11	12	13	14
	Frame header	Slave address	Slave address	4	Operation command	Operation command	Setting data	Setting data	Setting data	Setting data	Checksum	Checksum	Checksum	Checksum	Frame end

Slave machine response	0	1	2	3	4	5	6	7	8	9	10	11	12	13	14	15	16	17
	Frame header	Slave address	Slave address	Slave machine response	Status feedback	Status feedback	0	Monitoring item	Monitoring item	Running data	Running data	Running data	Running data	Checksum	Checksum	Checksum	Checksum	Frame end

The setting data in the frame sent by main machine is the set frequency sent from main machine to slave machine.

The running data in the slave machine response frame is running parameter sent by main machine, which is determined by setting content of monitoring item (function code: [F3.08]) in inverter functional parameter list, and slave machine responds the item monitoring value.



The inverter functional parameter list refers to Chapter 5 of E550 series inverter operation manual: Functional parameter list.

1.4 Example

1.4.1 Read status and feature information of slave machine (Command classification 0)

Data setting: Read model of slave machine

Sent by main machine	Frame header	Slave address	Command type	Operation command	Data classification	Data subitem	Checksum	Frame end
Number of bits	1	2	1	2	1	2	4	1
Example	2A	30 30	30	30 31	30	30 30	30 31 38 31	0D
	5A	00 00	00	00 01	00	00 00	00 00 00 01	0D
Description	Frame header	Address 00	No. 0 command	Start	No data classification		Hexadecimal accumulation	Frame end

Data feedback: the model is 2S0004.

Slave machine response	Frame header	Slave address	Slave response	Status feedback	Data classification	Feature information	Checksum	Frame end
Number of bits	1	2	1	2	1	6	4	1
Example	2A	30 30	30	30 33	30	32 30 30 30 30 34	30 32 34 39	0D
	5A	00 00	00	00 03	00	02 00 00 00 00 04	00 00 00 09	0D
Description	Frame header	No.0 slave machine response	Slave machine receives data	Slave machine in stop condition	No data classification	02 – voltage class -2S 04 – power 0.4KW	Hexadecimal accumulation or decimal accumulation	Frame end

1.4.2 Read running parameters of slave machine (Command classification 1)

Data setting: read d-6(current set frequency).

Sent by main machine	Frame header	Slave address	Command classification	Operating command	Data classification	Data subitem	Checksum	Frame end
Number of bits	1	2	1	2	1	2	4	1
Example	2A	30 30	31	30 30	30	30 36	30 31 38 37	0D
	5A	00 00	01	00 00	00	00 06	00 00 00 07	0D
Description	Frame header	Address 00	No. 1 command	Invalid command	d parameter group	d parameter number	Hexadecimal accumulation	Frame end

Data feedback: Return to set frequency of 50.0Hz.

Slave machine response	Frame header	Slave address	Slave response	Status feedback	Display parameter	Data subitem	Operating Data	Checksum	Frame end
No. of bits	1	2	1	2	1	2	4	4	1
Example	2A	30 30	30	30 33	30	30 36	30 31 46 34	30 32 36 34	0D
	5A	00 00	00	00 03	00	00 06	00 00 01 F4	00 00 00 FE	0D
Description	Frame header	No.0 slave machine response	Slave machine receives data	Slave machine in stop condition	d parameter group	No data classification	Set frequency 50.0Hz	Hexadecimal accumulation	Frame end

1.4.3 Read function code parameters (Command classification 2)

Data setting: Read [F0.08] parameter

Sent by main machine	Frame header	Slave address	Command type	Operating command	Data classification	Data address	Checksum	Frame end
Number of bits	1	2	1	2	1	2	4	1
Example	2A	30 30	32	30 30	30	30 38	30 31 38 41	0D
	5A	00 00	02	00 00	00	00 08	00 00 00 0A	0D
Description	Frame header	Address 00	No.2 command	Invalid control command	F parameter group	F parameter number	Hexadecimal accumulation	Frame end

Data feedback: Carrier wave frequency [F0.08] = 8.0KHz.

Slave machine response	Frame header	Slave address	Slave response	Status feedback	Data classification	Data subitem	Return data	Checksum	Frame end
Number of bits	1	2	1	2	1	2	4	4	1
Example	2A	30 30	30	30 33	30	30 38	30 30 35 30	30 32 35 30	0D
	5A	00 00	00	00 03	00	00 08	00 00 00 50	00 00 00 5B	0D
Description	Frame header	No.0 slave machine response	Slave machine receives data	Slave machine in stop condition	F0 parameter group	F0.08	Return data is 8.0KHz	Hexadecimal accumulation	Frame end

1.4.4 Modify function code parameters in inverter RAM area (Command classification 3)

Data setting: modify digital set frequency [F0.01] = 50.0Hz, stop without storage.

Sent by main machine	Frame header	Slave address	Command type	Operating command	Data classification	Data subitem	setting Data	Checksum	Frame end
Number of bits	1	2	1	2	1	2	4	4	1
Example	2A	30 30	33	30 30	30	30 31	30 31 46 34	30 32 35 46	0D
	5A	00 00	03	00 00	00	00 01	00 00 01 F4	00 00 00 F9	0D
Description	Frame header	Address 00	No.3 command	Invalid control command	F0 parameter group	F0.01 Parameter	set Frequency 50.0Hz	Hexadecimal accumulation	Frame end

Data feedback: correct data setting.

Slave machine response	Frame header	Slave address	Slave response	Status feedback	Data classification	Data address	Setting data	Checksum	Frame end
Number of bits	1	2	1	2	1	2	4	4	1
Exp.	2A	30 30	30	30 33	30	30 31	30 31 46 34	30 32 35 46	0D
	5A	00 00	00	00 03	00	00 01	00 00 01 F4	00 00 00 F9	0D
Description	Frame header	No.0 slave machine response	Slave machine receives data	Slave machine in stop condition	F0 parameter group	F0.01	Setting data 50.0 Hz	Hexadecimal accumulation	Frame end

1.4.5 Send control command (Command classification 4)

Data setting: Set FWD running frequency of No. 0 inverter of slave machine as 10.0Hz.

Sent by main machine	Frame header	Slave address	Command type	Operating command	Setting data	Checksum	Frame end
Number of bits	1	2	1	2	4	4	1
Example	2A	30 30	34	31 31	30 30 36 34	30 31 43 30	0D
	5A	00 00	04	00 11	00 00 00 64	00 00 00 79	0D
Description	Frame header	Address 00	No. 4 command	FWD tape frequency setting	set frequency 10.0Hz	Hexadecimal accumulation	Frame end

Data feedback: No. 0 inverter receives data in normal condition.

Slave machine response	Frame header	Slave address	Slave response	Status feedback	0	Monitoring item	Operating data	Checksum	Frame end
Number of bits	1	2	1	2	1	2	4	4	1
Example	2A	30 30	30	30 31	30	30 30	30 30 36 34	30 32 34 42	0D
	5A	00 00	00	00 01	00	00 00	00 00 00 64	00 00 00 65	0D
Description	Frame header	No.0 slave machine response	Slave machine receives data	FWD running of slave machine	Fixed Data	Current displayed monitoring d-0	Successful data Setting	Hexadecimal accumulation	Frame end

1.4.6 Modify EPROM parameters (Command classification 5)

Data sending: Modify torque boost [F0.11]=6.0, stop and store.

Main machine sending	Frame header	Slave address	Command type	Operating command	Data classification	Data subitem	setting Data	Check-sum	Frame end
Number of bits	1	2	1	2	1	2	4	4	1
Example	2A	30 30	35	30 31	30	30 41	30 30 33 43	30 32 36 44	0D
	5A	00 00	05	00 01	00	00 0B	00 00 00 3C	00 00 00 4D	0D
Description	Frame header	Address 00	Command #5	FWD running of slave machine	F0 Parameter group	F0.11 Parameter	Data setting	Hexadecimal accumulation	Frame end

Data feedback: Slave machine receives data normally.

Slave machine response	Frame header	Slave address	Slave response	Status feedback	Data classification	Data address	setting Data	Checksum	Frame end
Number of bits	1	2	1	2	1	2	4	4	1
Example	2A	30 30	30	30 31	30	30 41	30 30 33 43	30 32 36 38	0D
	5A	00 00	00	00 01	00	00 0B	00 00 00 3C	00 00 00 48	0D
Description	Frame header	No.0 slave machine response	Slave machine receives data	FWD running of slave machine	F0 Parameter group	F0.11	Successful data setting	Hexadecimal accumulation	Frame end

Appendix II: MODBUS Protocol Specification

1. Communication setting

F4.00=X1XX, select MODBUS RTU protocol;

Note: X represents that the bit is arbitrary number.

2. Communication function

Complete communication between upper machine and inverter, including sending operation command to inverter, setting running frequency, rewriting function code parameter, reading running status of inverter, monitoring parameter, fault message and function code parameter.

3. Protocol format

MODBUS RTU format

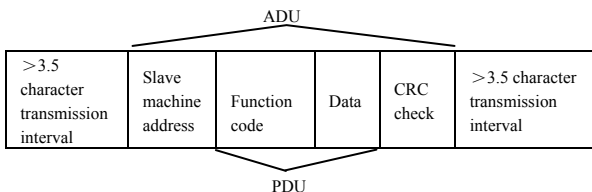

1.1 Interpretation of protocol format

1. Slave address

0 is broadcast address and the slave address can be set as 1-30.

2. PDU part

(1) **Function code 03:** Read functional parameters, running status, monitoring parameter and fault message of multiple inverters, and 6 inverter parameters with continuous address at most in one time.

Sent by main machine:

PDU PART	03	Register initial address		Number of registers	
		High	Low	High	Low
Data length(Byte)	1	1	1	1	1

Slave machine response:

PDU PART	03	Number of reading bytes (2*Number of registers)	Reading content
Data length(Byte)	1	1	2*Number of registers

(2) **Function code 06:** Rewrite operation command, running frequency and functional parameter of single inverter.

Sent by main machine:

PDU PART	06	Register initial address		Register data	
		High	Low	High	Low
Data length(Byte)	1	1	1	1	1

Slave machine response:

PDU PART	06	Register initial address		Register data	
		High	Low	High	Low
Data length(Byte)	1	1	1	1	1

(3) **Function code 10:** Rewrite operation command, running frequency and functional parameter of multiple inverters.

Sent by main machine:

PDU PART	10	Register initial address		Number of registers		Content byte count	Register content
		High	Low	High	Low		
Data length(Byte)	1	1	1	1	1	1	2*Number of registers

Slave machine response:

PDU PART	10	Register initial address		Number of registers	
		High	Low	High	Low
Data length(Byte)	1	1	1	1	1

Notice: the inverter starts to store data from the register with lowest address to that with the highest address, and 6 function codes can be saved at most in one time; in case of identifying some error, the slave machine will make objection response.

Objection response:

PDU PART	0x80 + Function code	Objection code
Data length(Byte)	1	1

Objection code indicates error category:

Objection code	Corresponding error
01	Illegal function code
02	Illegal data address
03	Overhanging data

Objection code	Corresponding error
04	Invalid operation of slave machine
20	Too much read-write parameters
21	Reserve read-write, implicit parameter
22	Slave machine running forbids modifying data
23	Data modification is protected by password
24	Failure in read-write parameter

CRC CHECK:

CRC CHECK	CRC Low	CRC High
Data length(Byte)	1	1

CRC CHECK function is shown as below:

```

unsigned int crc_chk_value(unsigned char *data_value, unsigned char length)
{
    unsigned int crc_value=0xFFFF;
    int i;
    while(length--)
        {
            crc_value^=*data_value++;
            for(i=0;i<8;i++)
                {
                    if(crc_value&0x0001)
                        crc_value=(crc_value>>1)^0xA001;
                    else
                        crc_value=crc_value>>1;
                }
        }
    return(crc_value);
}

```

3. Definition of communication parameter address

Distribution of inverter parameter address

Register implication	Register address space
Functional parameter ⁽¹⁾	High is the number of function code group, while low is mark number of function code, e.g. F1.11, the register address is F10B.
Monitoring parameter	High is 0xD0 and low is monitoring mark number, e.g. d-12, the register address is D00C
Operation command ⁽²⁾	0x1001
Frequency setting	0x1002
Inverter status ⁽³⁾	0x2000
Fault message ⁽⁴⁾	0x2001

Note:

(1)The frequent writing of function code parameters in the EEPROM will reduce its service life. Some parameters in the communication mode don't need to store, but to modify the RAM value. When writing the functional parameter of RAM, just change "F" to "0" in the high address of the register, e.g. when writing the RAM value of F1.11, its register address should be 010 B, but the expression method of the register address cannot be used to read the functional parameters of the frequency inverter.

(2) Operation command corresponding to operation command code:

Operation command code	Operation command
0x0000	Invalid command
0x0001	FWD running start
0x0002	REV running start
0x0003	Stop
0x0004	FWD inching of slave machine
0x0005	REV inching of slave machine
0x0006	Inching running stops
0x0020	Fault reset of slave machine

(3) Inverter status:

Inverter status code	Indication
0x0000	The direct voltage of slave machine is not ready
0x0001	In FWD running of slave machine
0x0002	In REV running of slave machine
0x0003	Slave machine stops
0x0004	In FWD inching running of slave machine
0x0005	In REV inching running of slave machine
0x0011	In FWD acceleration
0x0012	In REV acceleration
0x0013	Instant stop and restart
0x0014	FWD deceleration
0x0015	REV deceleration
0x0016	Slave machine stays in DC braking condition
0x0020	Slave machine stays in fault condition

(4)The high fault message code is 0, while low is corresponding to the rear mark number of inverter fault code-Fu., e.g. if the fault message code is 0x000C, it represents that inverter fault code is Fu.12.

1.2 Example

(1). Start 1 # inverter in FWD running condition

Main machine request:

Slave machine address	Function code	Register initial address		Register data		CRC CHECK	
		High	Low	High	Low	Low	High
01	06	10	01	00	01	1D	0A

Slave machine response: inverter in FWD running condition responds the same data with main machine request.

(2). Set inverter running frequency as 50.0Hz

Main machine request:

Slave machine address	Function code	Register initial address		Register data		CRC CHECK	
		High	Low	High	Low	Low	High
01	06	10	02	01	F4	2C	DD

Slave machine response: inverter in 50.0Hz running condition responds the same data with main machine request.

(3). Read current running frequency, output current, inverter response frequency 50.0Hz and output current 1.1A of inverter.

Main machine request:

Slave machine address	Function code	Register initial address		Number of registers		CRC CHECK	
		High	Low	High	Low	Low	High
01	03	D0	00	00	02	FC	CB

Slave machine response:

Slave machine address	Function code	Number of reading bytes	1st register data		2nd register data		CRC CHECK	
			High	Low	High	Low	Low	High
01	03	04	01	F4	00	0B	FB	FA

(4). Start 1 # inverter in FWD running condition and set inverter running

Frequency as 40.0Hz.

Main machine request:

Slave machine address	Function code	Register initial address		Number of registers		Number of content bytes	1st register data		2nd register data		CRC CHECK	
		High	Low	High	Low		High	Low	High	Low	Low	High
01	10	10	01	00	02	04	00	01	01	90	AF	9F

Slave machine response:

Slave machine address	Function code	Register initial address		Number of registers		CRC CHECK	
		High	Low	High	Low	Low	High
01	10	10	01	00	02	14	C8

Appendix III: Brake resistor selection

In running process of inverter, in case that controlled motor speed falls too fast or motor load shakes too fast, the electromotive force will charge inverter internal capacitance through inverter in reverse direction, therefore, voltage at two ends of power module will be boosted to damage inverter possibly. The inverter internal control will be suppressed based on loading condition; in case of brake performance failing to meet customer requirements, it's necessary to connect with external brake resistor to realize immediate release of energy. The external brake resistor belongs to energy-consumption brake mode, which will consume all energy on power brake resistor. Therefore, selection of power and resistance value of brake resistor must be reasonable. The following content refers to introducing brake resistor power and resistance value recommended to be employed for SUNFAR inverter. Based on loading condition, user can modify value properly in line with the range specified by SUNFAR inverter.

Inverter model	Applicable motor (KW)	Brake resistor power (KW)	Brake resistance value (Ω)	Braking torque (%)
E550-2S0004	0.4	0.1	150	100
E550-2S0007	0.75	0.1	100	100
E550-2S0015	1.5	0.2	70	100
E550-2S0022	2.2	0.2	50	100
E550-2S0030	3.0	0.4	40	100
E550-2S0040	4.0	0.4	35	100
E550-4T0007	0.75	0.1	400	100
E550-4T0015	1.5	0.2	300	100
E550-4T0022	2.2	0.4	200	100
E550-4T0030	3.0	0.4	150	100
E550-4T0040	4.0	0.5	125	100

The above configuration is to realize 100% braking torque, it's necessary to select value in actual use based on braking condition. In case of weak braking, please reduce brake resistance properly and increase brake resistance power class in proportion.



The brake resistance power is the estimated value in working condition of brake resistance interval; when continuous working time of brake resistance is longer (more than 5s), it's necessary to properly increase power class of brake resistance under the condition of same resistance value.