



ES884 – ES888



ES915



ES919 – ES929 – ES939



ES983 – ES988



Information about the document

CODE	REVISION	APPROVAL
5801H0056	04	UTE 002 / 07

List of updates

Revision	Modified paragraph	Description of the modification
00 (12.02.2007)	First issue	First issue
01 (06.03.2007)	§12.7 §12.7.2	Elimination of the note "respect the number of rotations ..."; elimination of the phrase "on the basis of the type and quality ..." (both the eliminated parts are already present in paragraph §12.7.1). Additional explanation of the simplified calculation for the centre of gravity.
02 (02.06.2008)	General § 5.2 § 6.2 § 6.4 § 9 § 10.3 § 10.4 § 10.6 § 10.8.5 § 13.2.2 § 13.2.2.9 § 15	Added ES884, ES888, ES915, ES919, ES939, ES983, ES988 models Symbols updated Wording on shaft kits corrected Glossary: generalised wording "ISO" and "HSK" Motor identification plates and equivalent electrical networks of all motors added Fixing specifications added Pressurisation values added Electrical connections of encoder models and with military connectors added Note on possible tie-rod breakage added Sensor connections and positions updated Sensor adjustment procedure for HSK E63 models added List of spare parts and note on shaft kit updated
03 (23.12.2010)		General
04 (18.06.2012)	4.4.3 4.4.5 4.6.1.1 6.9.4.2 9.1 11	Pneumatic diagram updated Pneumatic diagram updated Electrical connections data update Termistore added Added model 939 Spare parts catalogue updated

This manual has been drawn up by the Electrospindles Technical Office of HSD S.p.A. and is to be used by all installers, users and maintenance engineers working with the electrospindle.

This manual is supplied together with the product; it is the most updated documentation available at the revision date.

For the updates, visit the website www.HSD.it or contact HSD Customer Service.

The manual must be kept in a suitable place that is easily accessed and known to the personnel using the product. In addition, it must be kept carefully for the entire lifespan of the product, and must accompany the product if this is ceded to third parties.

This publication is the English translation of the original Italian version of the manual HSD. In case of discrepancies between this translation and the original version, refer to the original version in Italian.

TABLE OF CONTENTS

1	PRELIMINARY INFORMATION	6
1.1	DOCUMENTS SUPPLIED WITH THE ELECTROSPINDLE	6
1.2	PURPOSE OF THE MANUAL	6
1.3	GENERAL SAFETY SYMBOLS	6
1.4	RISKS ASSOCIATED WITH THE USE OF THE ELECTROSPINDLE	7
1.5	RISKS ASSOCIATED WITH INCORRECT USE AND/OR OPERATION	7
1.6	SPECIFIC RISKS DURING ELECTROSPINDLE MAINTENANCE	8
1.7	RESIDUAL RISKS	8
1.8	PURPOSE OF THE PRODUCT	8
1.9	RANGE OF APPLICATIONS	8
1.10	IDENTIFICATION OF THE PRODUCT AND THE MANUFACTURER	8
1.11	GLOSSARY	9
1.12	GUARANTEE CONDITIONS	10
2	TECHNICAL SPECIFICATIONS	11
2.1	MAIN PARTS OF ES915/ES919/ES929/ES988	11
2.2	MAIN PARTS OF MODELS ES884 - ES888	12
2.3	MAIN PARTS OF MODEL ES939	13
2.4	VARIATIONS WITH VERTICAL MOUNTING PLATE	14
2.5	VARIATIONS WITH MILITARY CONNECTORS	15
2.6	TECHNICAL CARDS ES884	16
2.7	TECHNICAL CARDS ES888	18
2.8	TECHNICAL CARDS ES915	20
2.9	TECHNICAL CARDS ES919	26
2.10	TECHNICAL CARDS ES929	40
2.11	TECHNICAL CARDS ES939	44
2.12	TECHNICAL CARDS ES983	52
3	TRANSPORT, PACKAGING, UNPACKING, STORAGE	65
3.1	WARNINGS	65
3.2	DIMENSIONS AND WEIGHTS	65
3.3	TRANSPORT AND PACKAGING CONDITIONS	65
3.4	UNPACKING PROCEDURE	65
3.5	STORAGE	66
4	INSTALLATION AND INITIAL START-UP	67
4.1	CHECK	67
4.2	PREPARATION OF THE AUXILIARY SYSTEMS OF THE PLANT	67
4.3	MECHANICAL CONNECTIONS	67
4.3.1	Positioning of electrospindle (versions with electric fan)	67
4.3.2	Electrospindle resting surface (versions with rectangular framework)	68
4.3.3	Fixing structure for spindles with round framework	68
4.3.4	Tool change system	69
4.3.5	Fixing electrospindles with rectangular framework	70
4.3.6	Fixing electrospindles with round framework	70
4.3.7	Threaded bores for accessories	70
4.4	PNEUMATIC CONNECTIONS	71
4.4.1	Air purity	71
4.4.2	Pneumatic connection points for spindles with single-acting cylinder	72
4.4.3	Variation with vertical block (single-acting cylinder)	72
4.4.4	Pneumatic connection points ES939 or variations with "T-block" (double-acting cylinder)	74
4.4.5	Pneumatic connection points for spindles ES884 - ES888 (single-acting cylinder)	76
4.4.6	Internal volumes of the pneumatic cylinders	78
4.4.7	Internal pressurisation	78

4.4.8	Cleaning the tool-holder cone	78
4.5	HYDRAULIC CONNECTIONS AND SPECIFICATIONS OF THE COOLER.....	79
4.5.1	Specifications for the cooler	79
4.6	ELECTRICAL CONNECTIONS.....	80
4.6.1	Connectors	80
4.6.2	Military connectors	83
4.6.3	Configurable power supply terminal board 220/380 V (optional)	84
4.6.4	ES988 with configurable terminal board 220/440 V (optional)	85
4.7	BUTTON FOR MANUAL COMMAND OF TOOL RELEASE.....	86
4.7.1	Electrical layout for tool-holder manual release circuit	86
5	GENERAL CHECKS AFTER INSTALLATION.....	87
5.1	CHECKS BEFORE THE START-UP.....	87
5.1.1	Positioning	87
5.1.2	Pneumatic connections	87
5.1.3	Electrical connections.....	87
5.1.4	Programming the inverter.....	87
5.2	START-UP CHECKS.....	87
6	USE AND ADJUSTMENT.....	88
6.1	ENVIRONMENTAL CONDITIONS	88
6.2	RUNNING-IN.....	88
6.3	PREHEATING.....	88
6.4	ELECTRIC FAN.....	88
6.4.1	Technical characteristics of the electric fan.....	89
6.5	TOOL-HOLDER LOCKING AND EXPULSION DEVICE	89
6.6	TOOL-HOLDER CONE	89
6.6.1	Installation of the tie-rod HSD 0804H0009 in the cone ISO30 DIN69871	90
6.6.2	General recommendations for the tool-holder cones	90
6.7	TOOL.....	90
6.7.1	Speed limits.....	91
6.7.2	Maximum speed and shape of the tool	91
6.8	WHAT TO DO IF THE TOOL IS BLOCKED ON THE PIECE BEING WORKED	111
6.9	SENSORS.....	113
6.9.1	Technical characteristics of the inductive sensors	113
6.9.2	Status modes of the electrospindle and corresponding outputs.....	114
6.9.3	Output of sensor S3: "shaft idle" signal	114
6.9.4	Use and technical characteristics of the thermal alarm	115
6.10	ENCODER (OPTIONAL).....	116
6.10.1	General description	116
6.10.2	Technical characteristics of the HSD Square Wave encoder.....	117
6.10.3	Output of the HSD Square Wave encoder	117
6.10.4	Technical characteristics of the Lenord+Bauer Square Wave encoder	118
6.10.5	Output of the Lenord+Bauer Square Wave encoder.....	118
6.10.6	Technical characteristics of the Lenord+Bauer sinusoidal encoder	119
7	MAINTENANCE.....	125
7.1	SCHEDULED MAINTENANCE	126
7.1.1	Checking the cleaning of the tool-holder cone and the conical housing in the spindle shaft	126
7.1.2	Purging the filters of the pneumatic circuit	127
7.1.3	Protecting the conical seat in the spindle shaft	128
7.1.4	Cleaning the tool-holder cone	128
7.1.5	Lubricating the HSK collet.....	128
7.1.6	Check of functionality collet HSK	129
7.1.7	Checking the connections	129
7.1.8	Replacing the filters of the pneumatic circuit.....	129

7.1.9	Bearings	129
8	REPLACING COMPONENTS.....	130
8.1	REPLACING THE ELECTRIC FAN	130
8.2	REPLACING THE SHAFT KIT FOR MODELS ES884, ES888	130
8.2.1	Disassembly procedure.....	130
8.2.2	Assembly procedure.....	132
8.3	REPLACING THE SHAFT KIT FOR MODELS ES915,ES919,ES929,ES988.....	134
8.3.1	Disassembly procedure.....	134
8.3.2	Assembly procedure.....	139
8.4	REPLACING THE SHAFT KIT FOR MODELS ES919 ENCODER	143
8.4.1	Disassembly procedure.....	143
8.4.2	Assembly procedure.....	146
8.5	REPLACING THE SHAFT KIT FOR MODELS ES939	149
8.6	REPLACING THE SHAFT KIT FOR MODELS ES939 WITH ENCODER.....	150
8.6.1	Cylinder unit disassembly.....	150
8.6.2	Disassembly of shaft kit and phonic wheel.....	152
8.7	REPLACING THE ENCODER READERS	155
8.7.1	Replacing the HSD optical encoder reader	155
8.8	REPLACING THE SENSORS	159
8.8.1	Wiring the sensors of ISO30 models with single-acting piston.....	159
8.8.2	Wiring the sensors of HSK models with single-acting piston	159
8.8.3	Wiring the sensors of ISO30 models with double-acting piston	160
8.8.4	Wiring the sensors of HSK models with double-acting piston	160
8.8.5	Wiring the sensors of HSK models with boosted mounting plate.....	161
8.8.6	Accessing the sensors	162
8.8.7	Position of the sensors	162
8.8.8	Accessing the ES939 sensors.....	163
8.8.9	Position of the ES939 sensors	163
8.8.10	Position of the sensors in models ES884/ES888	164
8.8.11	Description of the sensor unit.....	164
8.8.12	Replacing the sensor unit.....	165
8.8.13	Adjusting sensor S1 (both ISO and HSK versions).....	166
8.8.14	Adjusting sensor S2 in ISO versions	167
8.8.15	Adjusting sensor S2 in HSK versions.....	168
8.8.16	Adjusting sensor S3 (both ISO and HSK versions).....	168
8.8.17	Adjusting sensor S4 (HSK versions only).....	169
8.8.18	Kit of gauges to adjust sensors S1 and S4 HSK F63 (code HSD 3811H0110)	170
8.8.19	Kit of gauges to adjust sensors S1 and S4 HSK E63 (code HSD 3811H0739)	172
9	OPTIONAL PARTS.....	174
9.1	COOLING WITH FORCED AIR.....	174
9.2	INSTALLATION OF THE KIT FOR COOLING WITH FORCED AIR.....	175
10	TROUBLESHOOTING	176
11	LIST OF SPARE PARTS	180
12	DISPOSAL	181
13	ASSISTANCE	182

1 PRELIMINARY INFORMATION

1.1 DOCUMENTS SUPPLIED WITH THE ELECTROSPINDLE

The documentation supplied with the product consists of:

- the Manufacturer's Declaration in accordance with Appendix IIB of Directive 2006/42/EC
- the product inspection certificate.
- this manual, containing the warnings and instructions for transport, installation, operation, maintenance and disposal of the product.



Check that all the documents defined above are present at the time of delivery; if necessary, request a new copy from HSD S.p.A.

1.2 PURPOSE OF THE MANUAL

- The manual is an integral part of the electrospindle and must **compulsorily** accompany it, otherwise the electrospindle would be without one of its essential safety requirements.
- The manual must be handled with care, distributed and made available to all persons concerned.
- The purpose of **the warnings** is to protect the safety of the persons exposed to residual risks.
- **The instructions** provide tips on the proper behaviour for the correct use of the product, as intended by the manufacturer.
- In the event that contradictions are discovered between these instructions and the safety standards, please contact HSD S.p.A. for any corrections and/or amendments, on +39 0721 205211.
- In order to avoid incorrect operations that could cause danger for people, it is important to read and understand all the documentation supplied with the electrospindle.
- It is important to keep this manual in a suitable place and always within reach for consultation.

1.3 GENERAL SAFETY SYMBOLS

In this manual, some information of particular interest may be preceded by one of the following symbols:



Indicates a procedure, practice or any other similar measure that, if not observed or correctly followed, may cause personal injuries.



Indicates an operational procedure, practice or any other similar measure that, if not observed or correctly followed, can damage or completely destroy the product.



Indicates that the marked part may be red-hot and must not be touched without due care.

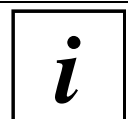

Indicates information of particular general interest that must not be ignored.

1.4 RISKS ASSOCIATED WITH THE USE OF THE ELECTROSPINDLE

- **HSD S.p.A. does not know, and cannot know, the conditions of installation of the product, so the installer or end user must carry out an analysis of the risks, relating specifically to the method and typology of installation.**
- It is, however, the responsibility of the party conducting the installation to guarantee an adequate degree of protection against the risk of accidental contact with moving parts and elements.
- The installer and user must also bear in mind other types of risk, in particular those arising from the presence of foreign bodies and from the transport of explosive, inflammable or toxic gases at high temperatures.
- Furthermore, consideration must be given to the risks inherent in the maintenance operations that must be carried out under conditions of maximum safety by isolating the electrospindle and with the tool at a standstill.
- The finished machine on which the HSD product is to be integrated will be subject to an **overall risk evaluation**, and a conformity declaration must be granted, according to Directive 2006/42/EC, appendix IIA, and successive amendments.
- **It is forbidden to put the product into operation before the machine into which it is to be incorporated complies with the provisions of Directive 2006/42/EC and successive amendments.**

1.5 RISKS ASSOCIATED WITH INCORRECT USE AND/OR OPERATION

- It is absolutely forbidden to disconnect, remove, modify or in any other way deactivate any safety, protection or monitoring device, both relating to individual devices and to the electrospindle as a whole.
- Do not place your hands, arms or any other parts of the body in the vicinity of moving parts.
- The use of the electrospindle in atmospheres or environments with the risk of explosion is forbidden.
- It is forbidden for an unauthorised operator to eliminate possible defects or faults in the functioning of the electrospindle and/or to change the type of operation and installation.
- After carrying out any special operations involving the removal of guards, barriers or other protective devices, install these again before restarting the electrospindle and check that they are correctly positioned and functioning efficiently.
- All the protective and safety devices must be maintained in a perfect and efficient condition at all times. The plates with indications, recommendations and danger warnings must be kept in place and fully efficient.
- When looking for the cause of any fault or malfunction of the electrospindle, take all the precautions described in the manual in order to avoid personal injury or damage to equipment.
- Remember to tighten all screws, bolts or ring nuts of all mechanical control or adjustment elements.
- Before starting up the electrospindle, ensure that all the safety devices are installed and in proper functional order; if this is not the case, it is absolutely forbidden to start it up, and the person responsible for internal safety or the section head must be informed immediately.
- The operator must be equipped with Personal Protective Equipment (PPE) in accordance with the provisions of the laws in force; wearing loose clothes and various accessories (ties, wide sleeves, etc.) is forbidden.
- It is absolutely forbidden to use types of tool holder that do not correspond to the models defined in the manual; this would cause the risk of breakage or imperfect hook-up of the tool holder cone.

1.6 SPECIFIC RISKS DURING ELECTROSPINDLE MAINTENANCE



To safely operate an HSD product fitted on the machine, refer to the manual of the machine itself.

- Disconnect the product from the main power supply before carrying out any maintenance operations!
- Even when the product is disconnected from the power supply, the rotating parts (and moving parts in general) can nevertheless move, due to their inertia; before carrying out maintenance operations therefore, check that the moving parts of the product are at a standstill.

1.7 RESIDUAL RISKS

The product has been analysed on the basis of Directives 2006/95/EC and 2006/42/EC in order to identify possible sources of risk. The risks that still remain (residual risks) and the respective countermeasures are described in the relevant sections of this manual.

1.8 PURPOSE OF THE PRODUCT

The product cannot work independently: it is a part of a machine, and is designed to be assembled with other machine parts, or to be incorporated in a machine, so as to form a machine in accordance with Directive 2006/42/EC.

It is forbidden to set the product into operation before the machine into which it is to be incorporated complies with the provisions of Directive 2006/42/EC and subsequent amendments.

1.9 RANGE OF APPLICATIONS

The product has been designed to carry out milling and boring operations in the field of wood and its derivatives, plastic, fibre, aluminium, and light machining operations on other metals.

The quick replacement of the shaft unit complete with bearings is possible on some models, using the "shaft kit". For further information see section 11 List of spare parts

All the electrospindles have a mechanical reaction system that neutralises the axial force of the piston on the shaft during the tool changing phase, guaranteeing the integrity of the precision bearings.

1.10 IDENTIFICATION OF THE PRODUCT AND THE MANUFACTURER

The EC marking plate and the serial number represent the only elements to identify the product acknowledged by HSD S.p.A. The user of the product is obliged to maintain the integrity of these signs.

In section 2 you can see the position of the EC mark and the serial number of the product.

1.11 GLOSSARY

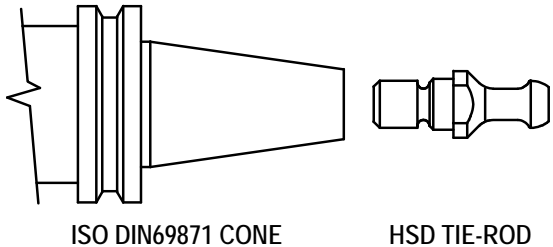
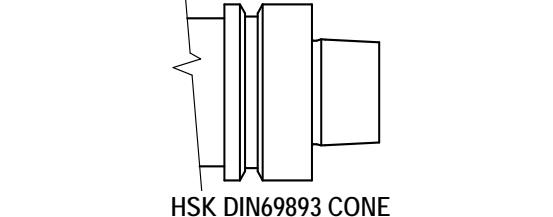
<p>ISO</p>	 <p>ISO DIN69871 CONE HSD TIE-ROD</p>	<p>Tool-holder cone hooking system, described by the standard DIN 69871.</p> <p>On the electrospindle there is a plate similar to that alongside, indicating the type of hook-up (ISO or HSK) and the type of HSD tie-rod (see paragraph 6.6).</p>
<p>HSK</p>	 <p>HSK DIN69893 CONE</p>	<p>Tool-holder cone hooking system, described by standard DIN 69893.</p> <p>The electrospindle has a plate similar to that alongside, indicating the type of hook-up (ISO or HSK).</p>
<p>Degree or type of dynamic balancing</p>	<p>Value of the balancing of a rotating object according to the standard ISO 1940/1, indicated by the letter G.</p> <p>Low G values correspond to higher balancings; the maximum balancing precision is G=0.4.</p> <p>G takes on discrete values in relation to multiples of 2.5 (G=0.4 G=1 G=2.5 ...).</p>	
<p>Routine maintenance</p>	<p>All the activities intended to maintain the operating and functioning conditions of the electrospindle as provided for by HSD S.p.A. at the moment of its launch on the market; it is carried out through scheduled operations to adjust, repair and replace parts.</p>	
<p>Service S1</p>	<p>Function under constant load, of a duration sufficient to allow the electrospindle to attain a thermal equilibrium.</p> <p>The corresponding abbreviation is S1.</p>	
<p>Service S6</p>	<p>Sequence of identical operating cycles, each comprising a period of operation under constant load and a period of operation without load while maintaining the rotational speed; there is no rest period.</p> <p>The corresponding abbreviation is S6, followed by the percentage ratio between the period of operation under load and the length of the cycle.</p> <p><i>Example: S6 40%.</i></p> <p>(40% period of operation under load, 60% period of operation in rotation without load).</p>	
<p>Rated voltage</p>	<p>Maximum power supply voltage of the electrospindle.</p>	
<p>Rated frequency</p>	<p>Minimum frequency at which rated voltage is supplied.</p>	
<p>Torque</p>	<div style="border: 1px solid black; padding: 5px; text-align: center;"> $\text{Torque (Nm)} = [60 \cdot \text{power (W)}] : [2 \cdot \Pi \cdot \text{rpm}]$ </div> <p>Providing a precise physical definition of torque and power would be going beyond the scope and possibility of this manual. Nevertheless the torque can be roughly correlated to the force with which the tool contacts the piece being machined (and for the same torque value, the force increases as the diameter of the tool decreases). The power, on the other hand, is proportional to the torque and the rotational speed and determines the maximum machining speed (taking into consideration the performance of the tool, the characteristics of the material being machined and the type of machining).</p>	
<p>Power</p>	<p>The power, on the other hand, is proportional to the torque and the rotational speed and determines the maximum machining speed (taking into consideration the performance of the tool, the characteristics of the material being machined and the type of machining).</p>	
<p>Nominal characteristics</p>	<p>All the various rated values reached in relation to the rated frequency.</p>	
<p>Coolant</p>	<p>Fluid, liquid or gas (including air) by means of which the heat is transferred from the spindle to the atmosphere.</p>	

1.12 GUARANTEE CONDITIONS

HSD S.p.A. guarantees that the electrospindle has been inspected at its plant with a positive result.

Works under warranty shall be performed free at the HSD S.p.A. facilities, transport at the customer's expense; HSD S.p.A. shall not be liable for termination of production during the warranty period.

The warranty does not cover faults due to normal wear of those parts which, by their nature, are subject to rapid and continuous wear (e.g. gaskets, belts, bearings, etc.). In particular, HSD S.p.A. gives no guarantee as to the working life of the bearings, as this depends on various factors including: the degree of balancing of the tools, the types of machining operation, collisions and/or mechanical stresses beyond the values indicated by the manufacturer.

HSD S.p.A. accepts no liability for faults in the conformity of the electrospindle caused by a failure to observe the standards of the instruction manual or the incorrect operation or handling of the electrospindle. **The buyer shall therefore have a right to replacement of parts found to be defective only if the faults have not been caused by tampering, namely by installing non-original HSD spare parts and/or replacing components not provided for and not authorised in this manual and, in any case, without the prior written approval of HSD S.p.A.**

On no account shall HSD S.p.A. or its suppliers be responsible for damage (including but not limited to damage to the physical integrity of the product or damages due to loss or reduced earnings, stoppages in production, loss of information or other economic losses) resulting from the use of HSD products, even in cases where HSD S.p.A. has been warned of the possibility of such damage.

The buyer's warranty shall be voided if HSD S.p.A. is not notified in detail, in writing, of the nature of any faults discovered in the electrospindle within 15 days of the fault being discovered. The buyer's warranty shall also be voided in the event that he does not allow the seller to carry out any requested inspections, or if the seller requests the return of the defective parts and the buyer fails to return them within two weeks of the request.

Measured drawings and photographs are provided purely as reference examples for a simpler understanding of the text.

In line with its policy of continuous development and advancement of the product, the company reserves the right to modify both its functional and aesthetic characteristics, to vary the design of any functional element or accessory, or to suspend production and delivery; this without undertaking to give notice to anyone and without incurring any other obligation. Furthermore, HSD S.p.A. reserves the right to make any structural or functional modifications, as well as the modification of the supplied spare parts and accessories, without the obligation of communicating these changes to anyone or assuming any other obligation.

2 TECHNICAL SPECIFICATIONS

2.1 MAIN PARTS OF ES915/ES919/ES929/ES988

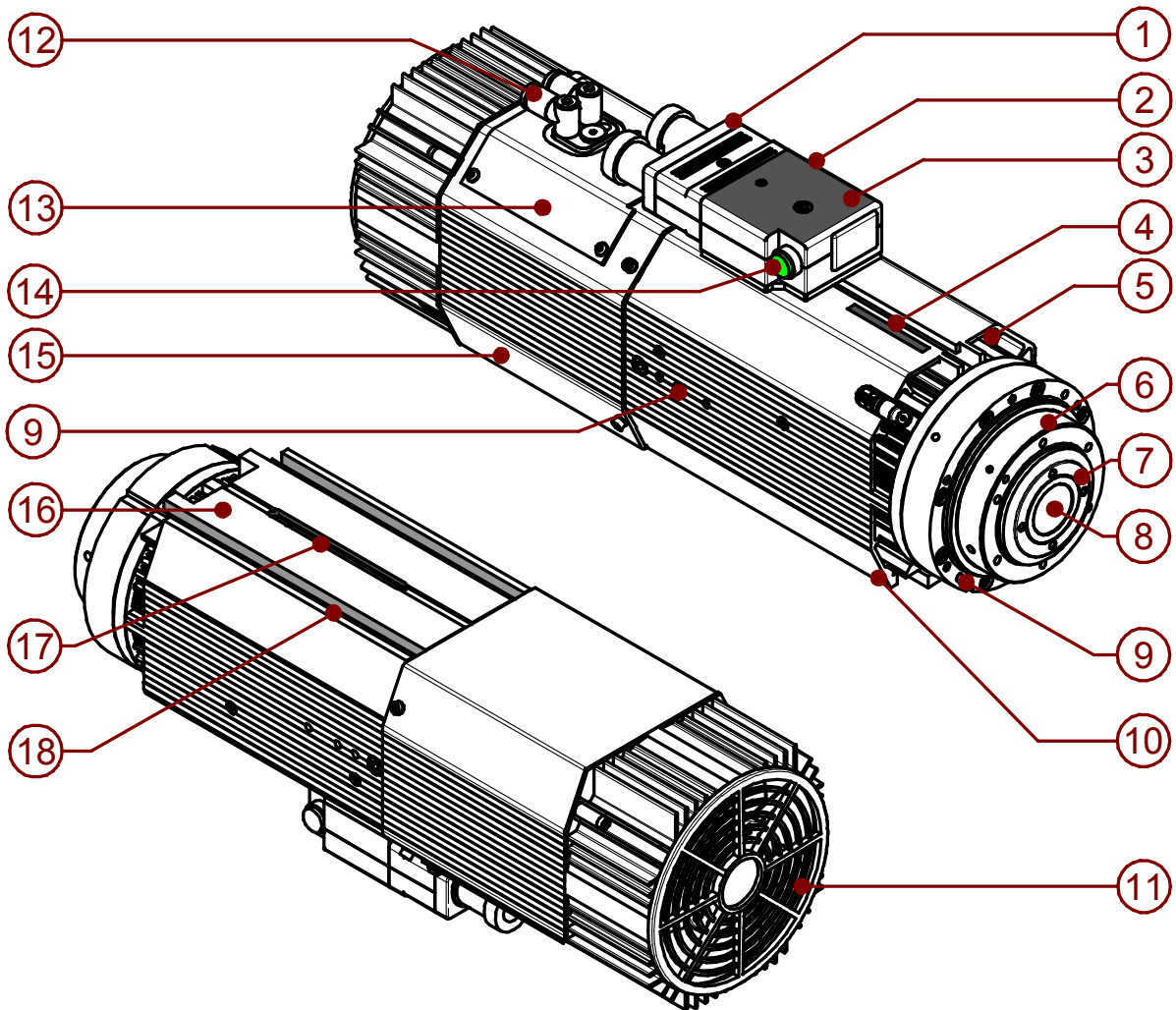

1	<i>Movable electrical connectors</i>	10	<i>Framework</i>
2	<i>Fixed electrical connectors</i>	11	<i>Electric fan (air-cooled versions only)</i>
3	<i>EC marking plate</i>	12	<i>Pneumatic connectors</i>
4	<i>Serial number</i>	13	<i>Cover of the sensor area</i>
5	<i>Connector for sensor on accessories (e.g. C-axis)</i>	14	<i>Button for the manual release of the tool-holder</i>
6	<i>"Nose"</i>	15	<i>Pneumatic cylinder</i>
7	<i>Shaft</i>	16	<i>Resting surface</i>
8	<i>Tool hooking system</i>	17	<i>Seat for centring tang</i>
9	<i>Threaded bores for accessories (on the sides and the front flange)</i>	18	<i>"T" slot for fixing</i>

2.2 MAIN PARTS OF MODELS ES884 - ES888

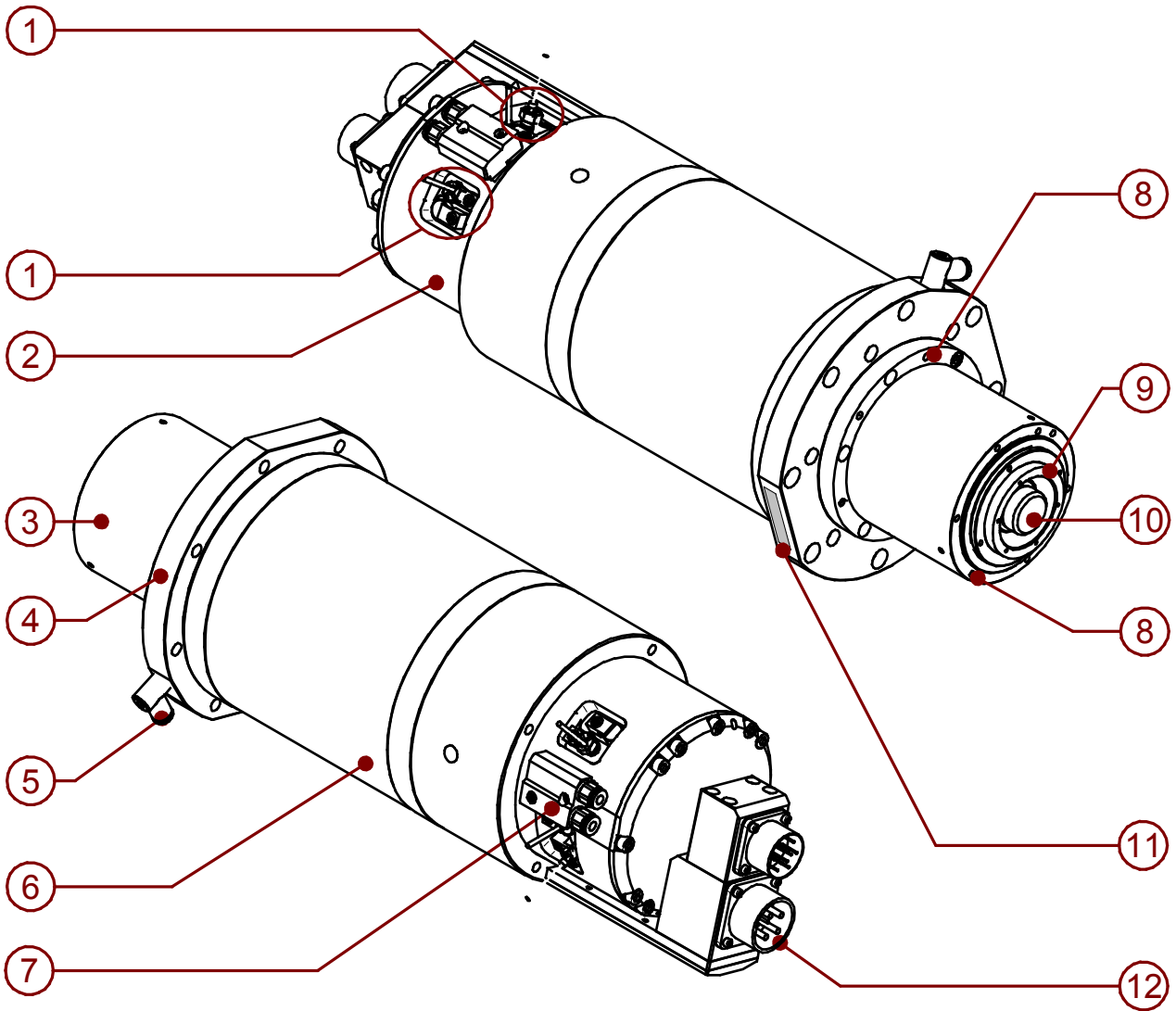

1	Sensor area	7	Pneumatic connections
2	Pneumatic cylinder	8	M6 threaded bores for accessories
3	"Nose"	9	Shaft
4	Fixing surface	10	Tool hooking system
5	Pressurisation connector	11	Serial number
6	Framework	12	Electrical connectors

2.3 MAIN PARTS OF MODEL ES939

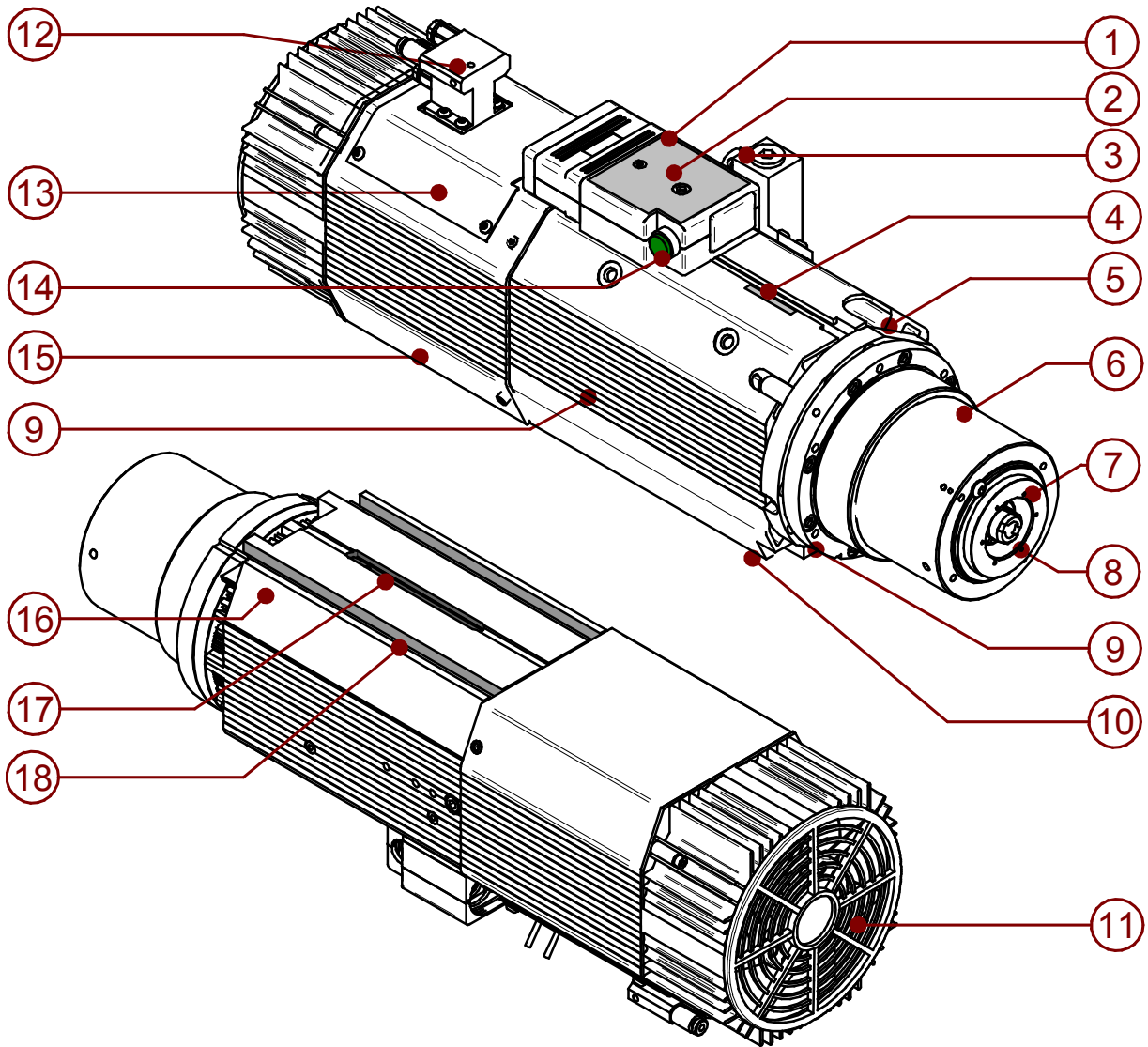

1	<i>Fixed electrical connectors</i>	10	<i>Framework</i>
2	<i>EC marking plate</i>	11	<i>Electric fan (air-cooled versions only)</i>
3	<i>Encoder connector</i>	12	<i>Pneumatic connectors</i>
4	<i>Serial number</i>	13	<i>Cover of the sensor area</i>
5	<i>Connector for sensor on accessories (e.g. C-axis)</i>	14	<i>Button for the manual release of the tool holder</i>
6	<i>"Nose"</i>	15	<i>Pneumatic cylinder</i>
7	<i>Shaft</i>	16	<i>Resting surface</i>
8	<i>Tool hooking system</i>	17	<i>Seat for centring tang</i>
9	<i>Threaded bores for accessories (on the sides and the front flange)</i>	18	<i>"T" slot for fixing</i>

2.4 VARIATIONS WITH VERTICAL MOUNTING PLATE

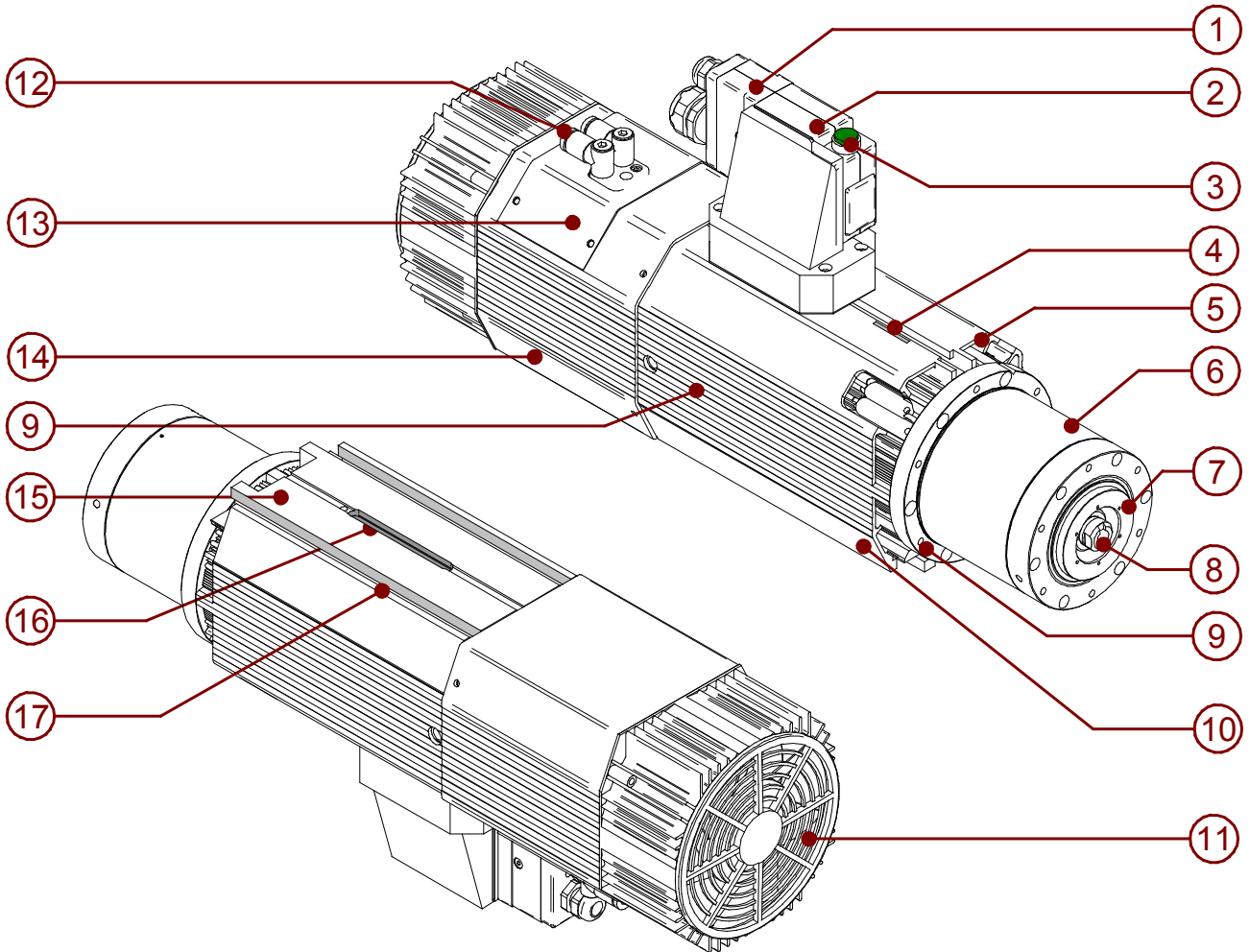

1	<i>Movable electrical connectors</i>	10	<i>Framework</i>
2	<i>Fixed electrical connectors</i>	11	<i>Electric fan (air-cooled versions only)</i>
3	<i>Button for the manual release of the tool-holder</i>	12	<i>Pneumatic connectors</i>
4	<i>Serial number</i>	13	<i>Cover of the sensor area</i>
5	<i>Connector for sensor on accessories (e.g. C-axis)</i>	14	<i>Pneumatic cylinder</i>
6	<i>"Nose"</i>	15	<i>Resting surface</i>
7	<i>Shaft</i>	16	<i>Seat for centring tang</i>
8	<i>Tool hooking system</i>	17	<i>"T" slot for fixing</i>
9	<i>Threaded bores for accessories (on the sides and the front flange)</i>		

2.5 VARIATIONS WITH MILITARY CONNECTORS

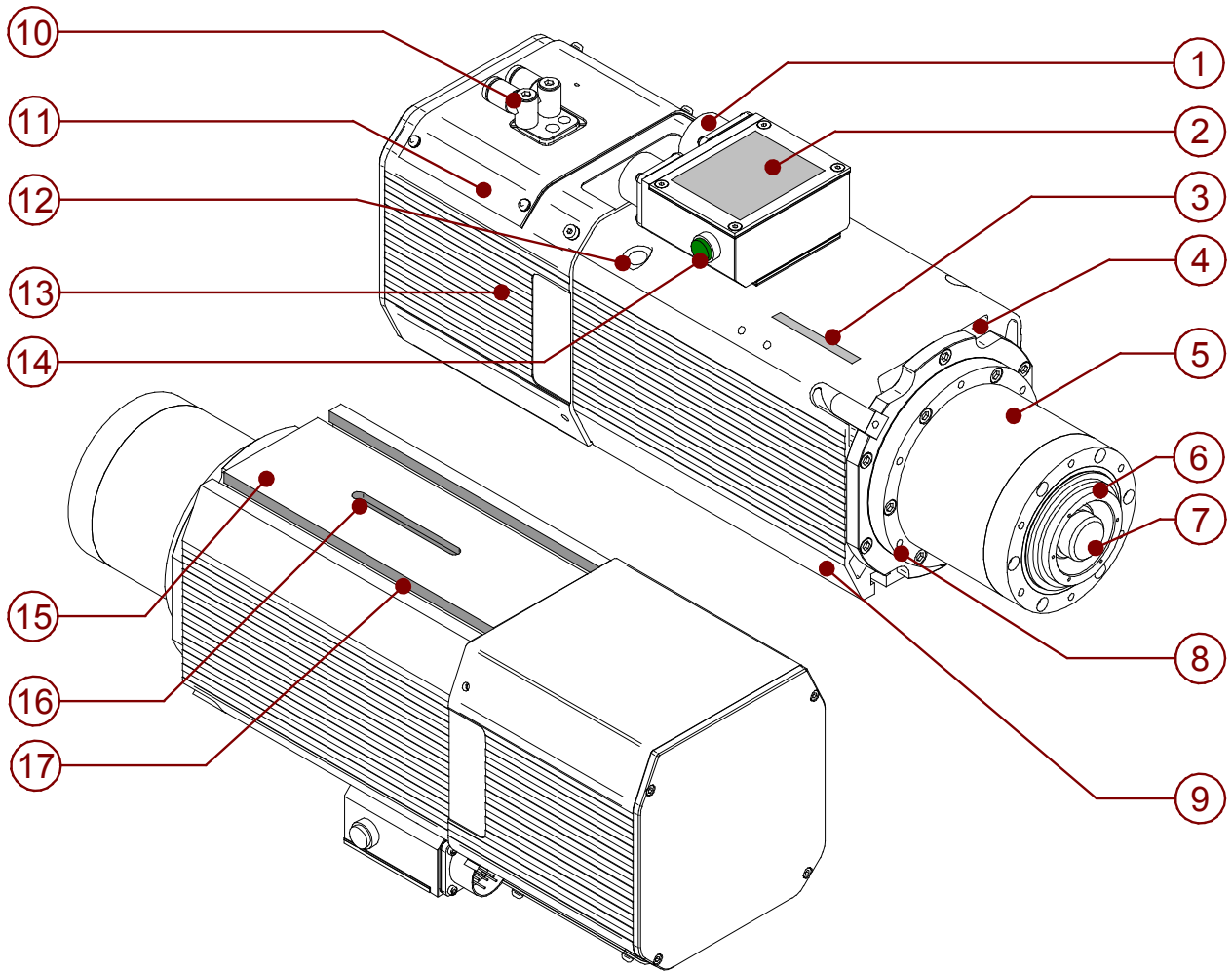

1	<i>Fixed electrical connectors</i>	10	<i>Pneumatic connectors</i>
2	<i>EC marking plate</i>	11	<i>Cover of the sensor area</i>
3	<i>Serial number</i>	12	<i>Motor cooling liquid inlet / outlet</i>
4	<i>Connector for sensor on accessories (e.g. C-axis)</i>	13	<i>Pneumatic cylinder</i>
5	<i>"Nose"</i>	14	<i>Button for the manual release of the tool-holder</i>
6	<i>Shaft</i>	15	<i>Resting surface</i>
7	<i>Tool hooking system</i>	16	<i>Seat for centring tang</i>
8	<i>Threaded bores for accessories (on the sides and the front flange)</i>	17	<i>"T" slot for fixing</i>
9	<i>Framework</i>		

2.6 TECHNICAL CARDS ES884

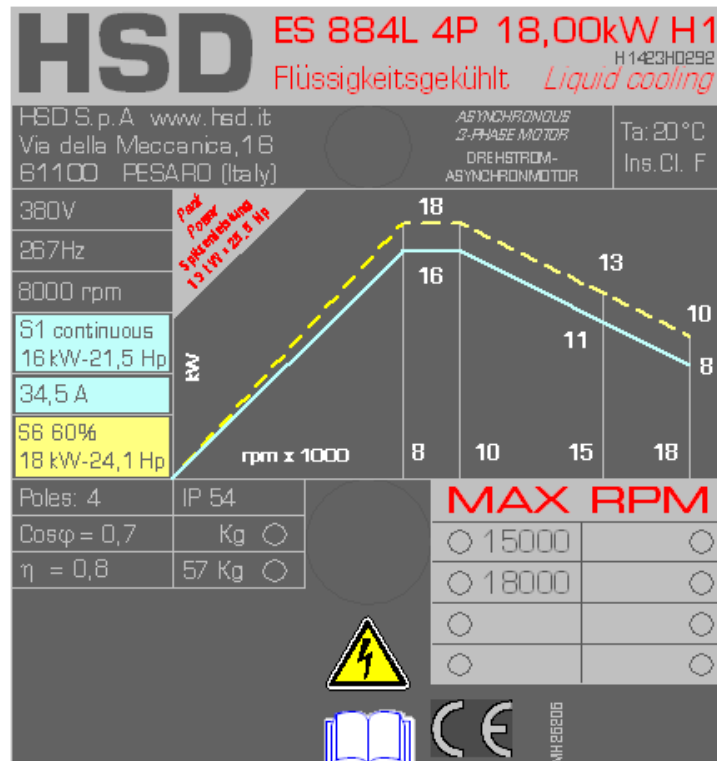

H1423H0292 Rev.02 (120.150.4A)

Rated voltage (*)	V	380	380	380	380	380	380	380	380
Rated frequency	Hz	267	333	500	600				
Rated speed	rpm	8,000	10000	15,000	18,000				
Duty type		S1 cont	S6 60%	S1 cont	S6 60%	S1 cont	S6 60%	S1 cont	S6 60%
Rated power	kW	16.0	18.0	16.0	18.0	11.0	13.0	8.0	10.0
Rated torque	Nm	19	21.5	15.3	17.2	7.0	8.3	4.2	5.3
Rated current	A	34.5	45	34.5	45	23.7	32.6	18.0	26.0
Rated output η		0.8							
Power factor cos φ		0.7							
Number of poles		4							
Type of insulation		F							
IP rating		54							
Type of cooling		Raffreddamento a liquido / Flüssigkeit / Liquid cooling							
Weight of LONG NOSE version	kg	~ 57							

[(*) supplied by inverter]

SP120.150.4A

Description	Unit of measurement	Value
Potenza nominale / rated power / nennleistung (S1)	kW	16
Corrente nominale / rated current / nennstrom (S1)	A	34.5
Tensione nominale concatenata / line rated voltage / nennspannung	V	380
Velocità nominale al carico nominale/ rated speed at rated load / nenn Drehzahl bei nennlast	Rpm	7810
Frequenza nominale / rated frequency / nennfrequenz	Hz	267
Tensione a vuoto concatenata / no-load line voltage / leerlaufspannung bei nennflussu	V	370
Corrente a vuoto / no-load current / leerlaufstrom	A	11
Resistenza dello statore / stator resistance / standerwiderstand kalt (20°C)	Ω	0.12
Resistenza del rotore /rotor resistance / lauferwiderstand kalt (20°C)	Ω	0.2
Reattanza di dispersione dello statore / stator leakage reactance / standerstreureaktanz	Ω	1
Reattanza di dispersione del rotore /rotor leakage reactance / lauferstreureaktanz	Ω	1.7
Reattanza del campo principale / main field reactance / hauptfeldreaktanz	Ω	19
Velocità di inizio indebolimento del campo / field weakening initial speed speed / Einsatzdrehzahl feldschwachung	Rpm	8000
Velocità massima del motore / motor maximum speed / Maximaldrehzahl	Rpm	18000
Fattore di potenza / power factor / nennleistungsfactor		0.8
Momento di inerzia del rotore / moment of inertia	Kg m2	0,0025
Collegamento / circuit connection / schaltungsart	Y or D	Y

2.7 TECHNICAL CARDS ES888

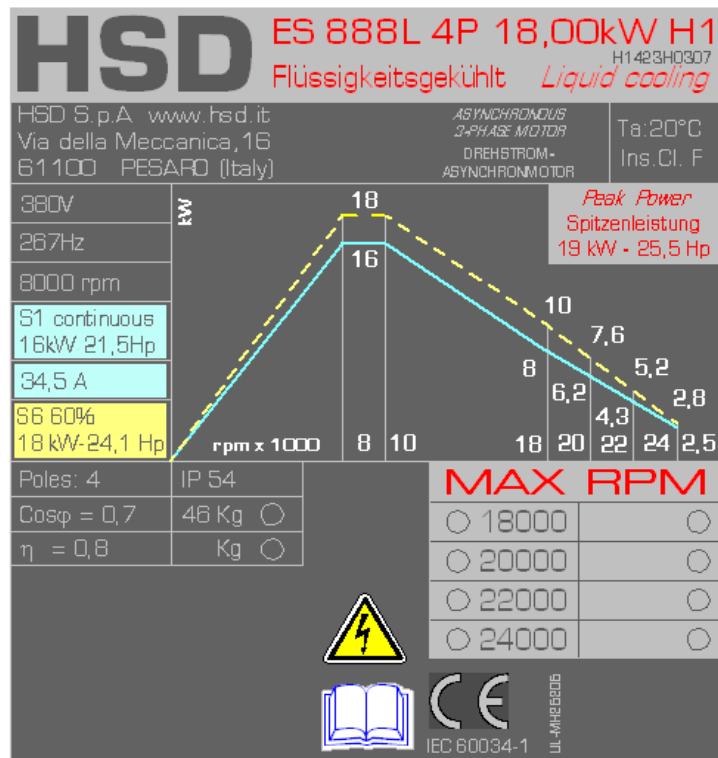

H1423H0307 Rev.00 (Ref.: H2120H0120 / SP.120.150.4A)													
Rated voltage (*)	V	380		380		380		380		380		380	
Rated frequency	Hz	267		333		600		667		733		800	
Rated speed	rpm	8,000		10000		18,000		20,000		22000		24,000	
Duty type		S1 cont	S6 60%	S1 cont	S6 60%	S1 cont	S6 60%	S1 cont	S6 60%	S1 cont	S6 60%	S1 cont	S6 60%
Rated power	kW	16	18	16	18	8	10	6.2	7.6	4.3	5.2	2.5	2.8
Rated torque	Nm	19	21.5	15.3	17.2	4.2	5.3	3	3.6	1.9	2.3	1.0	1.1
Rated current	A	34.5	45	34.5	45	18	26	14.3	17.2	8	11	4.6	5
Rated output η		0.8											
Power factor cos φ		0.7											
Number of poles		4											
Type of insulation		F											
IP rating		54											
Type of cooling		Raffreddamento a liquido / Flüssigkeit / Liquid cooling											
Weight of LONG NOSE version	kg	~ 46											
[*] supplied by inverter													

SP120.150.4A

Description	Unit of measurement	Value
Potenza nominale / rated power / nennleistung (S1)	kW	16
Corrente nominale / rated current / nennstrom (S1)	A	34.5
Tensione nominale concatenata / line rated voltage / nennspannung	V	380
Velocità nominale al carico nominale/ rated speed at rated load / nenn Drehzahl bei nennlast	Rpm	7810
Frequenza nominale / rated frequency / nennfrequenz	Hz	267
Tensione a vuoto concatenata / no-load line voltage / leerlaufspannung bei nennflussu	V	370
Corrente a vuoto / no-load current / leerlaufstrom	A	11
Resistenza dello statore / stator resistance / standerwiderstand kalt (20°C)	Ω	0.12
Resistenza del rotore /rotor resistance / lauferwiderstand kalt (20°C)	Ω	0.2
Reattanza di dispersione dello statore / stator leakage reactance / standerstreureaktanz	Ω	1
Reattanza di dispersione del rotore /rotor leakage reactance / lauferstreureaktanz	Ω	1.7
Reattanza del campo principale / main field reactance / hauptfeldreaktanz	Ω	19
Velocità di inizio indebolimento del campo / field weakening initial speed speed / Einsatzdrehzahl feldschwachung	Rpm	8000
Velocità massima del motore / motor maximum speed / Maximaldrehzahl	Rpm	18000
Fattore di potenza / power factor / nennleistungsfactor		0.8
Momento di inerzia del rotore / moment of inertia	Kg m2	0.0025
Collegamento / circuit connection / schaltungsart	Y or D	Y

2.8 TECHNICAL CARDS ES915

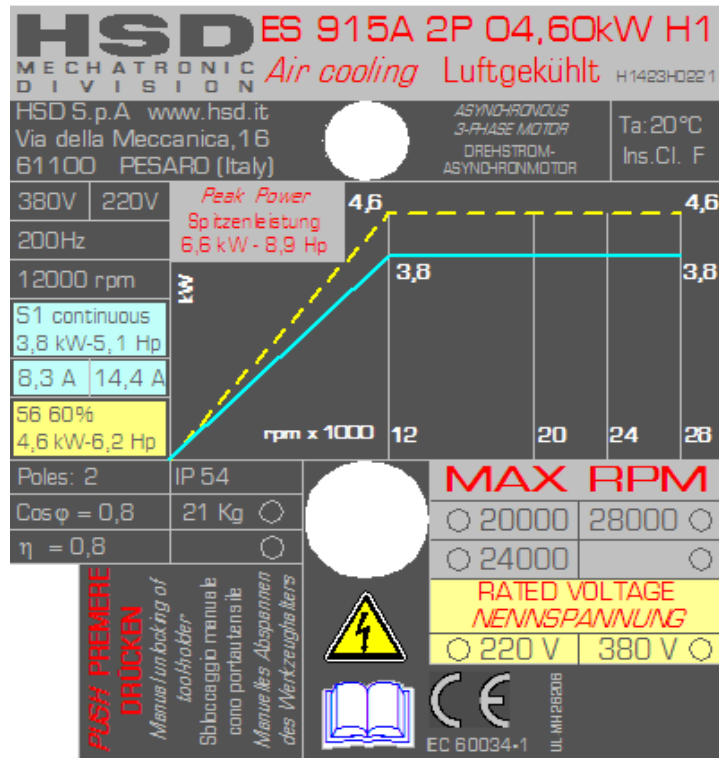

H1423H0221 Rev.04
(SP.110.70.24)

		STAR CONNECTION								DELTA CONNECTION							
Rated voltage (*)	V	380		380		380		380		220		220		220		220	
Rated frequency	Hz	200		333		400		466		200		333		400		466	
Rated speed	rpm	12000		20000		24000		28000		12000		20000		24000		28000	
Duty type		S1 cont	S6 60%	S1 cont	S6 60%	S1 cont	S6 60%	S1 cont	S6 60%	S1 cont	S6 60%	S1 cont	S6 60%	S1 cont	S6 60%	S1 cont	S6 60%
Rated power	kW	3.8	4.6	3.8	4.6	3.8	4.6	3.8	4.6	3.8	4.6	3.8	4.6	3.8	4.6	3.8	4.6
Rated torque	Nm	3	3.7	1.8	2.2	1.5	1.8	1.3	1.6	3	3.7	1.8	2.2	1.5	1.8	1.3	1.6
Rated current	A	8.3	10	8.3	10	8.3	10	8.3	10	14.4	17.3	14.4	17.3	14.4	17.3	14.4	17.3
Rated output η		0.8															
Power factor cos φ		0.8															
Number of poles		2															
Type of insulation		F															
Type of cooling		Elettroventola / Elektrolüfter / Cooling fan															
Weight of SHORT NOSE version	kg	~ 21															

[(*) supplied by inverter]

SP 110.70.24

Description	Unit of measurement	Value
Potenza nominale / rated power / nennleistung (S1)	kW	3.7
Corrente nominale / rated current / nennstrom (S1)	A	8.3
Tensione nominale concatenata / line rated voltage / nennspannung	V	380
Velocità nominale al carico nominale/ rated speed at rated load / nenn Drehzahl bei nennlast	Rpm	11800
Frequenza nominale / rated frequency / nennfrequenz	Hz	200
Tensione a vuoto concatenata / no-load line voltage / leerlaufspannung bei nennflussu	V	370
Corrente a vuoto / no-load current / leerlaufstrom	A	2.6
Resistenza dello statore / stator resistance / standerwiderstand kalt (20°C)	Ω	0.67
Resistenza del rotore /rotor resistance / lauferwiderstand kalt (20°C)	Ω	0.65
Reattanza di dispersione dello statore / stator leakage reactance / standerstreureaktanz	Ω	2.1
Reattanza di dispersione del rotore /rotor leakage reactance / lauferstreureaktanz	Ω	3.8
Reattanza del campo principale / main field reactance / hauptfeldreaktanz	Ω	82
Velocità di inizio indebolimento del campo / field weakening initial speed speed / Einsatzdrehzahl feldschwachung	Rpm	12000
Velocità massima del motore / motor maximum speed / Maximaldrehzahl	Rpm	12000
Fattore di potenza / power factor / nennleistungsfactor		0.8
Collegamento / circuit connection / schaltungsart	Y or D	Y

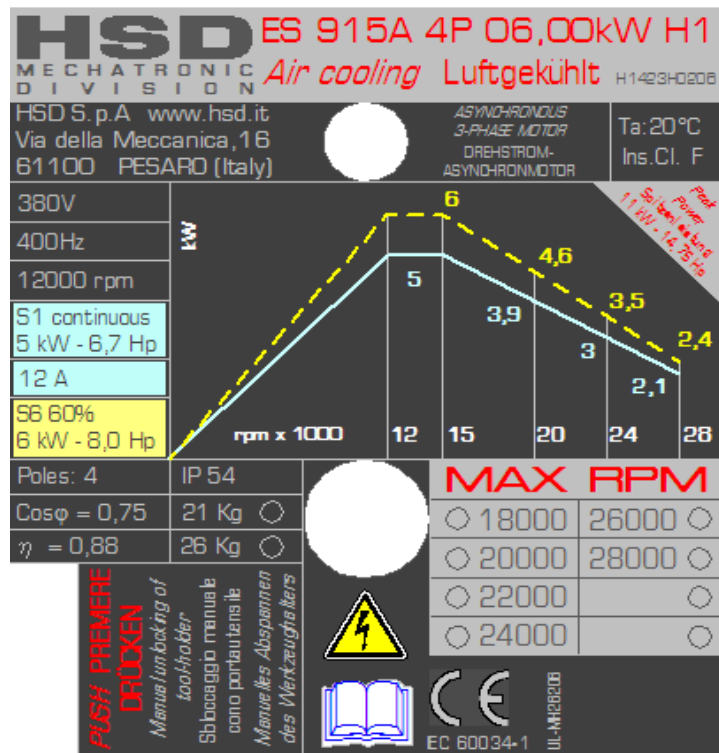

H1423H0206_Rev02 SP.110.070.42											
Rated voltage (*)	V	380		380		380		380		380	
Rated frequency	Hz	400		500		667		800		933	
Rated speed	rpm	12,000		15,000		20,000		24,000		28,000	
Duty type		S1 cont	S6 60%	S1 cont	S6 60%	S1 cont	S6 60%	S1 cont	S6 60%	S1 cont	S6 60%
Rated power	kW	5	6	5	6	3.9	4.6	3	3.5	2.1	2.4
Rated torque	Nm	4	4.8	3.2	3.8	1.7	2.2	1.2	1.4	0.7	0.8
Rated current	A	12	14	10.5	14	9.2	10.5	7	8	4	4.5
Rated output η		0.86									
Power factor cosφ		0.82									
Number of poles		4									
Type of insulation		F									
Type of cooling		Elettroventola / Elektrolüfter / Cooling fan									
Weight of SHORT NOSE version	kg	~ 21									
Weight of LONG NOSE version	kg	~ 26									

[(*) supplied by inverter]

SP110.70.42_Air

Description	Unit of measurement	Value
Potenza nominale / rated power / nennleistung (S1)	kW	5
Corrente nominale / rated current / nennstrom (S1)	A	10.5
Tensione nominale concatenata / line rated voltage / nennspannung	V	380
Velocità nominale al carico nominale/ rated speed at rated load / nenn Drehzahl bei nennlast	Rpm	11850
Frequenza nominale / rated frequency / nennfrequenz	Hz	400
Tensione a vuoto concatenata / no-load line voltage / leerlaufspannung bei nennflussu	V	370
Corrente a vuoto / no-load current / leerlaufstrom	A	4.3
Resistenza dello statore / stator resistance / standerwiderstand kalt (20°C)	Ω	0.27
Resistenza del rotore /rotor resistance / lauferwiderstand kalt (20°C)	Ω	0.24
Reattanza di dispersione dello statore / stator leakage reactance / standerstreureaktanz	Ω	1.6
Reattanza di dispersione del rotore /rotor leakage reactance / lauferstreureaktanz	Ω	3.2
Reattanza del campo principale / main field reactance / hauptfeldreaktanz	Ω	50
Velocità di inizio indebolimento del campo / field weakening initial speed speed / Einsatzdrehzahl feldschwachung	Rpm	12000
Velocità massima del motore / motor maximum speed / Maximaldrehzahl	Rpm	24000
Fattore di potenza / power factor / nennleistungsfactor		0.85
Momento di inerzia del rotore / moment of inertia	Kg m2	1.1E-03
Collegamento / circuit connection / schaltungsart	Y or D	Y

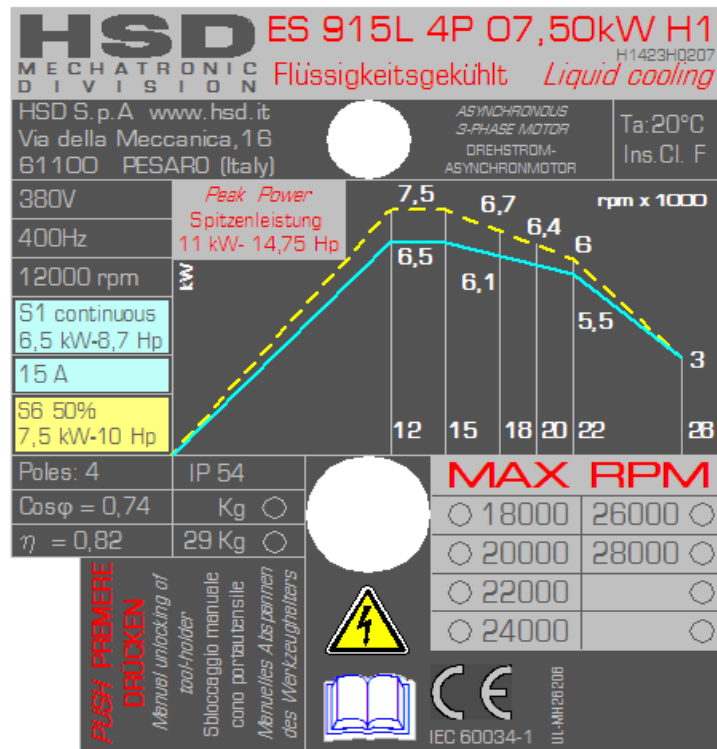

H1423H0207 Rev.02 (ST 110.070.42)													
Rated voltage (*)	V	380		380		380		380		380		380	
Rated frequency	Hz	400		500		600		667		733		933	
Rated speed	rpm	12,000		15,000		18,000		20,000		22000		28,000	
Duty type		S1 cont	S6 50%	S1 cont	S6 50%	S1 cont	S6 50%	S1 cont	S6 50%	S1 cont	S6 50%	S1 cont	S6 50%
Rated power	kW	6.5	7.5	6.5	7.5	6.1	6.7	5.8	6.4	5.5	6	3	3
Rated torque	Nm	5.2	6	4.1	4.8	3.2	3.6	2.8	3.1	2.4	2.6	1	1
Rated current	A	15	18	15	18	14	15.7	13	16	13.1	14.1	7.5	7.5
Rated output η		0.82											
Power factor cosφ		0.74											
Number of poles		4											
Type of insulation		F											
Type of cooling		Raffreddamento a liquido / Flüssigkeit / Liquid cooling											
Weight of LONG NOSE version	kg	~ 29											

[(*) supplied by inverter]

SP110.70.42_Liquid

Description	Unit of measurement	Value
Potenza nominale / rated power / nennleistung (S1)	kW	6.5
Corrente nominale / rated current / nennstrom (S1)	A	13.2
Tensione nominale concatenata / line rated voltage / nennspannung	V	380
Velocità nominale al carico nominale/ rated speed at rated load / nenn Drehzahl bei nennlast	Rpm	11850
Frequenza nominale / rated frequency / nennfrequenz	Hz	400
Tensione a vuoto concatenata / no-load line voltage / leerlaufspannung bei nennflussu	V	370
Corrente a vuoto / no-load current / leerlaufstrom	A	4.3
Resistenza dello statore / stator resistance / standerwiderstand kalt (20°C)	Ω	0.27
Resistenza del rotore /rotor resistance / lauferwiderstand kalt (20°C)	Ω	0.24
Reattanza di dispersione dello statore / stator leakage reactance / standerstreureaktanz	Ω	1.6
Reattanza di dispersione del rotore /rotor leakage reactance / lauferstreureaktanz	Ω	3.2
Reattanza del campo principale / main field reactance / hauptfeldreaktanz	Ω	50
Velocità di inizio indebolimento del campo / field weakening initial speed speed / Einsatzdrehzahl feldschwachung	Rpm	12000
Velocità massima del motore / motor maximum speed / Maximaldrehzahl	Rpm	24000
Fattore di potenza / power factor / nennleistungsfactor		0.85
Momento di inerzia del rotore / moment of inertia	Kg m2	1.1E-03
Collegamento / circuit connection / schaltungsart	Y or D	Y

2.9 TECHNICAL CARDS ES919

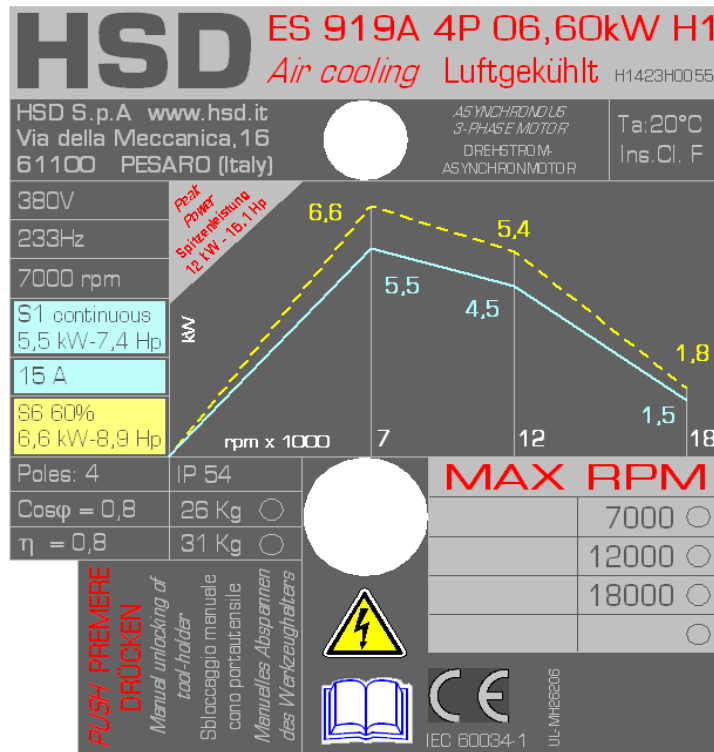

H1423H0055 Rev.03 (SP.110.130.45)							
Rated voltage (*)	V	380		380		380	
Rated frequency	Hz	233		400		600	
Rated speed	rpm	7000		12,000		18,000	
Duty type		S1 cont	S6 60%	S1 cont	S6 60%	S1 cont	S6 60%
Rated power	kW	5.5	6.6	4.5	5.4	1.5	1.8
	Nm	7.5	9	3.6	4.3	0.8	1
Rated current	A	15	18	14	17	6.5	8
Rated output η		0.8					
Power factor cosφ		0.8					
Number of poles		4					
Type of insulation		F					
Type of cooling		Elettroventola / Elektrolüfter / Cooling fan					
Weight of SHORT NOSE version	kg	~ 26					
Weight of LONG NOSE version	kg	~ 31					

[(*) supplied by inverter]

SP110.130.45

Description	Unit of measurement	Value
Potenza nominale / rated power / nennleistung (S1)	kW	5.5
Corrente nominale / rated current / nennstrom (S1)	A	15
Tensione nominale concatenata / line rated voltage / nennspannung	V	380
Velocità nominale al carico nominale/ rated speed at rated load / nenn Drehzahl bei nennlast	Rpm	6870
Frequenza nominale / rated frequency / nennfrequenz	Hz	233
Tensione a vuoto concatenata / no-load line voltage / leerlaufspannung bei nennflussu	V	355
Corrente a vuoto / no-load current / leerlaufstrom	A	4.2
Resistenza dello statore / stator resistance / standerwiderstand kalt (20°C)	Ω	0.38
Resistenza del rotore /rotor resistance / lauferwiderstand kalt (20°C)	Ω	0.4
Reattanza di dispersione dello statore / stator leakage reactance / standerstreureaktanz	Ω	3.4
Reattanza di dispersione del rotore /rotor leakage reactance / lauferstreureaktanz	Ω	2.6
Reattanza del campo principale / main field reactance / hauptfeldreaktanz	Ω	49
Velocità di inizio indebolimento del campo / field weakening initial speed speed / Einsatzdrehzahl feldschwachung	Rpm	7000
Velocità massima del motore / motor maximum speed / Maximaldrehzahl	Rpm	18000
Fattore di potenza / power factor / nennleistungsfactor		0.85
Momento di inerzia del rotore / moment of inertia	Kg m2	1.8E-03
Collegamento / circuit connection / schaltungsart	Y or D	D

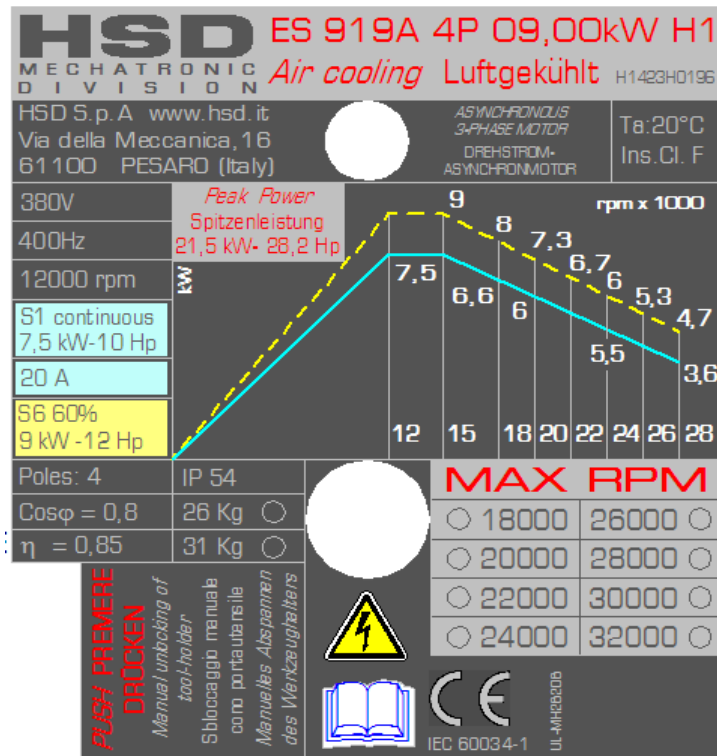

H1423H0196 Rev.01 (SP.110.130.48)																	
Rated voltage (*)	V	380		380		380		380		380		380		380		380	
Rated frequency	Hz	400		500		600		667		733		800		867		933	
Rated speed	rpm	12,000		15,000		18,000		20,000		22000		24,000		26000		28,000	
Duty type		S1 cont	S6 60%	S1 cont	S6 60%	S1 cont	S6 60%	S1 cont	S6 60%	S1 cont	S6 60%	S1 cont	S6 60%	S1 cont	S6 60%	S1 cont	S6 60%
Rated power	kW	7.5	9	7.5	9	6.6	8	6	7.3	5.8	6.7	5.5	6	4.2	5.3	3.6	4.7
Rated torque	Nm	6	7.2	4.8	5.7	3.5	4.2	2.9	3.5	2.5	2.9	2.2	2.4	1.5	2	1.2	1.6
Rated current	A	20	22.5	17	20.5	16	18.5	15	17.5	13	15	13	14	10	12.6	11.5	15
Rated output η		0.85															
Power factor cosφ		0.8															
Number of poles		4															
Type of insulation		F															
Type of cooling		Elettroventola / Elektrolüfter / Cooling fan															
Weight of SHORT NOSE version	kg	~ 26															
Weight of LONG NOSE version	kg	~ 31															

[(*) supplied by inverter]

SP110.130.48 (air-cooled)

Description	Unit of measurement	Value
Potenza nominale / rated power / nennleistung (S1)	kW	7.5
Corrente nominale / rated current / nennstrom (S1)	A	20
Tensione nominale concatenata / line rated voltage / nennspannung	V	380
Velocità nominale al carico nominale/ rated speed at rated load / nenn Drehzahl bei nennlast	Rpm	11910
Frequenza nominale / rated frequency / nennfrequenz	Hz	400
Tensione a vuoto concatenata / no-load line voltage / leerlaufspannung bei nennflussu	V	360
Corrente a vuoto / no-load current / leerlaufstrom	A	12
Resistenza dello statore / stator resistance / standerwiderstand kalt (20°C)	Ω	0.12
Resistenza del rotore /rotor resistance / lauferwiderstand kalt (20°C)	Ω	0.14
Reattanza di dispersione dello statore / stator leakage reactance / standerstreureaktanz	Ω	1.2
Reattanza di dispersione del rotore /rotor leakage reactance / lauferstreureaktanz	Ω	1.9
Reattanza del campo principale / main field reactance / hauptfeldreaktanz	Ω	25
Velocità di inizio indebolimento del campo / field weakening initial speed speed / Einsatzdrehzahl feldschwachung	Rpm	12000
Fattore di potenza / power factor / nennleistungsfactor		0.85
Momento di inerzia del rotore / moment of inertia	Kg m2	1.8E-03
Collegamento / circuit connection / schaltungsart	Y or D	Y

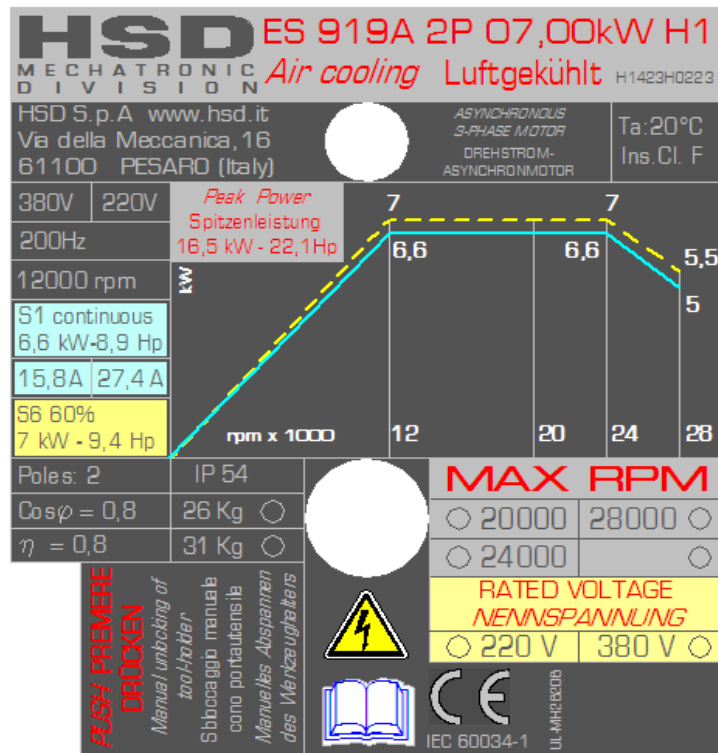

H1423H0223 Rev.01
(SP.110.130.29)

		COLLEGAMENTO STELLA STERNSCHALTUNG STAR CONNECTION								COLLEGAMENTO TRIANGOLO DREIECKSCHALTUNG DELTA CONNECTION							
Rated voltage (*)	V	380	380	380	380	220	220	220	220	220	220	220	220	220	220	220	220
Rated frequency	Hz	200	333	400	466	200	333	400	466	200	333	400	466	200	333	400	466
Rated speed	rpm	12,000	20,000	24,000	28,000	12,000	20,000	24,000	28,000	12,000	20,000	24,000	28,000	12,000	20,000	24,000	28,000
Duty type		S1 cont	S6 60%	S1 cont	S6 60%	S1 cont	S6 60%	S1 cont	S6 60%	S1 cont	S6 60%	S1 cont	S6 60%	S1 cont	S6 60%	S1 cont	S6 60%
Rated power	kW	6.6	7	6.6	7	6.6	7	5	5.5	6.6	7	6.6	7	6.6	7	5	5.5
Rated torque	Nm	5.3	5.6	3.2	3.3	2.6	2.8	1.7	1.9	5.3	5.6	3.2	3.3	2.6	2.8	1.7	1.9
Rated current	A	15.8	18	15.8	18	15.8	18	15	17	27.4	31.2	27.4	31.2	27.4	31.2	26	29.4
Rated output η		0.8															
Power factor $\cos\phi$		0.8															
Number of poles		2															
Type of insulation		F															
Type of cooling		Elettroventola / Elektrolüfter / Cooling fan															
Weight of SHORT NOSE version	kg	~ 26															
Weight of LONG NOSE version	kg	~ 31															

[(*) supplied by inverter]

SP110.130.29 (delta connection)

Description	Unit of measurement	Value
Potenza nominale / rated power / nennleistung (S1)	kW	6.6
Corrente nominale / rated current / nennstrom (S1)	A	27.4
Tensione nominale concatenata / line rated voltage / nennspannung	V	220
Velocità nominale al carico nominale/ rated speed at rated load / nennndrehzahl bei nennlast	Rpm	11840
Frequenza nominale / rated frequency / nennfrequenz	Hz	200
Tensione a vuoto concatenata / no-load line voltage / leerlaufspannung bei nennflussu	V	211
Corrente a vuoto / no-load current / leerlaufstrom	A	17
Resistenza dello statore / stator resistance / standerwiderstand kalt (20°C)	Ω	0.07
Resistenza del rotore /rotor resistance / lauferwiderstand kalt (20°C)	Ω	0.09
Reattanza di dispersione dello statore / stator leakage reactance / standerstreureaktanz	Ω	0.29
Reattanza di dispersione del rotore /rotor leakage reactance / lauferstreureaktanz	Ω	0.6
Reattanza del campo principale / main field reactance / hauptfeldreaktanz	Ω	7
Velocità di inizio indebolimento del campo / field weakening initial speed speed / Einsatzdrehzahl feldschwachung	Rpm	12000
Velocità massima del motore / motor maximum speed / Maximaldrehzahl	Rpm	24000
Fattore di potenza / power factor / nennleistungsfactor		0.65
Momento di inerzia del rotore / moment of inertia	Kg m2	1.6E-03
Collegamento / circuit connection / schaltungsart	Y or D	D

SP110.130.29 (star connection)

Description	Unit of measurement	Value
Potenza nominale / rated power / nennleistung (S1)	kW	6.6
Corrente nominale / rated current / nennstrom (S1)	A	15.8
Tensione nominale concatenata / line rated voltage / nennspannung	V	380
Velocità nominale al carico nominale/ rated speed at rated load / nenn Drehzahl bei nennlast	Rpm	11840
Frequenza nominale / rated frequency / nennfrequenz	Hz	200
Tensione a vuoto concatenata / no-load line voltage / leerlaufspannung bei nennflussu	V	364
Corrente a vuoto / no-load current / leerlaufstrom	A	10
Resistenza dello statore / stator resistance / standerwiderstand kalt (20°C)	Ω	0.2
Resistenza del rotore /rotor resistance / lauferwiderstand kalt (20°C)	Ω	0.28
Reattanza di dispersione dello statore / stator leakage reactance / standerstreureaktanz	Ω	0.87
Reattanza di dispersione del rotore /rotor leakage reactance / lauferstreureaktanz	Ω	1.8
Reattanza del campo principale / main field reactance / hauptfeldreaktanz	Ω	22
Velocità di inizio indebolimento del campo / field weakening initial speed speed / Einsatzdrehzahl feldschwachung	Rpm	12000
Velocità massima del motore / motor maximum speed / Maximaldrehzahl	Rpm	24000
Fattore di potenza / power factor / nennleistungsfactor		0.72
Momento di inerzia del rotore / moment of inertia	Kg m2	1.6E-03
Collegamento / circuit connection / schaltungsart	Y or D	Y

HSD ES 919A 2P 08,00kW H1
 MECHATRONIC DIVISION *Air cooling* Luftgekühlt H1423H0224

HSD S.p.A www.hsd.it
 Via della Meccanica, 16
 61100 PESARO (Italy)

ASYNCHRONOUS 3-PHASE MOTOR
 DREI-STROM-ASYNCHRONMOTOR

Ta: 20°C
 Ins.Cl. F

380V 220V
 200Hz
 12000 rpm

Peak Power
 Spitzenleistung
 19 kW - 25,5 Hp

8 8

6,6 6,6 5,5 5 4,3 4,2

12 20 24 28 30

rpm x 1000

S1 continuous
 6,6 kW-8,9 Hp

15,8A 27,4A

S6 60%
 8 kW-10,7 Hp

Poles: 2 IP 54

Cosφ = 0,8 26 Kg

η = 0,8 31 Kg

MAX RPM

○ 20000 28000 ○
 ○ 24000 30000 ○

RATED VOLTAGE
 NENNSPANNUNG

○ 220 V 380 V ○

PUSH PREMIERE
DRÜCKEN
 Manual unloading of
 tool-holder
 Sbloccaggio manuale
 cono portautensile
 Manuelles Abspannen
 des Werkzeughalters





CE IEC 60034-1 UL-MICRODIE

H1423H0224 Rev.02 (SP.110.130.29)		COLLEGAMENTO STELLA STERNSCHALTUNG STAR CONNECTION										COLLEGAMENTO TRIANGOLO DREIECKSCHALTUNG DELTA CONNECTION											
Rated voltage (*)	V	380	380	380	380	380	220	220	220	220	220	380	380	380	380	380	220	220	220	220	220		
Rated frequency	Hz	200	333	400	466	500	200	333	400	466	500	200	333	400	466	500	200	333	400	466	500		
Rated speed	rpm	12,000	20,000	24,000	28,000	30000	12,000	20,000	24,000	28,000	30000	12,000	20,000	24,000	28,000	30000	12,000	20,000	24,000	28,000	30000		
Duty type		S1 cont	S6 60%	S1 cont	S6 60%	S1 cont	S6 60%	S1 cont	S6 60%	S1 cont	S6 60%	S1 cont	S6 60%	S1 cont	S6 60%	S1 cont	S6 60%	S1 cont	S6 60%	S1 cont	S6 60%		
Rated power	kW	6.6	8	6.6	8	6.6	8	5	5.5	4.2	4.3	6.6	8	6.6	8	6.6	8	5	5.5	4.2	4.3		
Rated torque	Nm	5.3	6.4	3.2	3.8	2.6	3.2	1.7	1.9	1.3	1.4	5.3	6.4	3.2	3.8	2.6	3.2	1.7	1.9	1.3	1.4		
Rated current	A	15.8	18	15.8	18	15.8	18	15	17	12.3	13.4	27.4	31.2	27.4	31.2	27.4	31.2	26	29.4	23	23.3		
Rated output η		0.8																					
Power factor cosφ		0.8																					
Number of poles		2																					
Type of insulation		F																					
Type of cooling		Elettroventola / Elektrolüfter / Cooling fan																					
Weight of SHORT NOSE version	kg	~ 26																					
Weight of LONG NOSE version	kg	~ 31																					
[(*) supplied by inverter]																							

SP110.130.29 (delta connection)

Description	Unit of measurement	Value
Potenza nominale / rated power / nennleistung (S1)	kW	6.6
Corrente nominale / rated current / nennstrom (S1)	A	27.4
Tensione nominale concatenata / line rated voltage / nennspannung	V	220
Velocità nominale al carico nominale/ rated speed at rated load / nennndrehzahl bei nennlast	Rpm	11840
Frequenza nominale / rated frequency / nennfrequenz	Hz	200
Tensione a vuoto concatenata / no-load line voltage / leerlaufspannung bei nennflussu	V	211
Corrente a vuoto / no-load current / leerlaufstrom	A	17
Resistenza dello statore / stator resistance / standerwiderstand kalt (20°C)	Ω	0.07
Resistenza del rotore /rotor resistance / lauferwiderstand kalt (20°C)	Ω	0.09
Reattanza di dispersione dello statore / stator leakage reactance / standerstreureaktanz	Ω	0.29
Reattanza di dispersione del rotore /rotor leakage reactance / lauferstreureaktanz	Ω	0.6
Reattanza del campo principale / main field reactance / hauptfeldreaktanz	Ω	7
Velocità di inizio indebolimento del campo / field weakening initial speed speed / Einsatzdrehzahl feldschwachung	Rpm	12000
Velocità massima del motore / motor maximum speed / Maximaldrehzahl	Rpm	24000
Fattore di potenza / power factor / nennleistungsfactor		0.65
Momento di inerzia del rotore / moment of inertia	Kg m2	1.6E-03
Collegamento / circuit connection / schaltungsart	Y or D	D

SP110.130.29 (star connection)

Description	Unit of measurement	Value
Potenza nominale / rated power / nennleistung (S1)	kW	6.6
Corrente nominale / rated current / nennstrom (S1)	A	15.8
Tensione nominale concatenata / line rated voltage / nennspannung	V	380
Velocità nominale al carico nominale/ rated speed at rated load / nenn Drehzahl bei nennlast	Rpm	11840
Frequenza nominale / rated frequency / nennfrequenz	Hz	200
Tensione a vuoto concatenata / no-load line voltage / leerlaufspannung bei nennflussu	V	364
Corrente a vuoto / no-load current / leerlaufstrom	A	10
Resistenza dello statore / stator resistance / standerwiderstand kalt (20°C)	Ω	0.2
Resistenza del rotore /rotor resistance / lauferwiderstand kalt (20°C)	Ω	0.28
Reattanza di dispersione dello statore / stator leakage reactance / standerstreureaktanz	Ω	0.87
Reattanza di dispersione del rotore /rotor leakage reactance / lauferstreureaktanz	Ω	1.8
Reattanza del campo principale / main field reactance / hauptfeldreaktanz	Ω	22
Velocità di inizio indebolimento del campo / field weakening initial speed speed / Einsatzdrehzahl feldschwachung	Rpm	12000
Velocità massima del motore / motor maximum speed / Maximaldrehzahl	Rpm	24000
Fattore di potenza / power factor / nennleistungsfactor		0.72
Momento di inerzia del rotore / moment of inertia	Kg m2	1.6E-03
Collegamento / circuit connection / schaltungsart	Y or D	Y

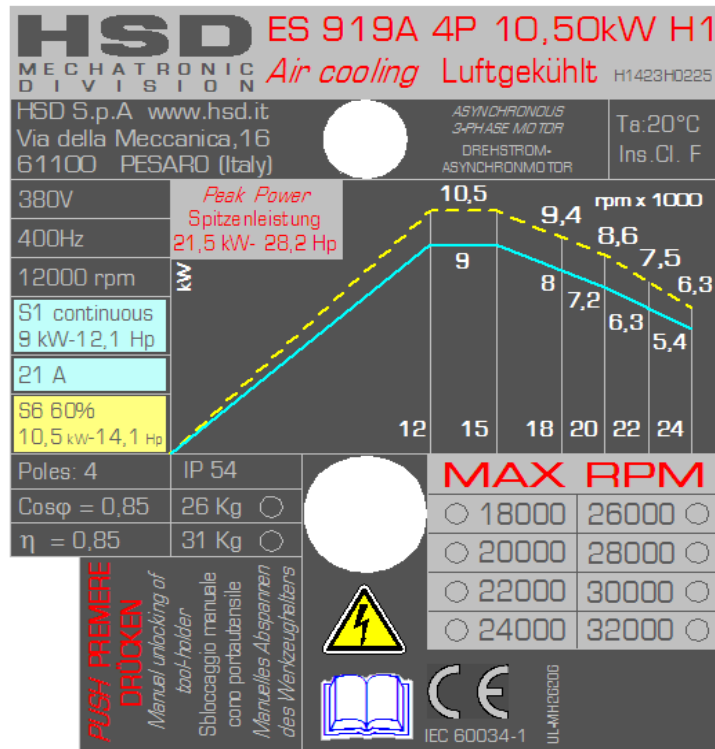

H1423H0225 Rev.01 (SP.110.130.4H)													
Rated voltage (*)	V	380		380		380		380		380		380	
Rated frequency	Hz	400		500		600		667		733		800	
Rated speed	rpm	12,000		15,000		18,000		20,000		22000		24,000	
Duty type		S1 cont	S6 60%	S1 cont	S6 60%	S1 cont	S6 60%	S1 cont	S6 60%	S1 cont	S6 60%	S1 cont	S6 60%
Rated power	kW	9	10.5	9	10.5	8	9.4	7.2	8.6	6.3	7.5	5.4	6.3
Rated torque	Nm	7.2	8.7	5.7	6.7	4.2	5	3.4	4.1	2.7	3.3	2.2	2.5
Rated current	A	21	25.3	19.2	22.5	17.5	20	15.8	19	14	17	12.9	14.7
Rated output η		0.85											
Power factor cosφ		0.85											
Number of poles		4											
Type of insulation		F											
Type of cooling		Elettroventola / Elektrolüfter / Cooling fan											
Weight of SHORT NOSE version	kg	~ 26											
Weight of LONG NOSE version	kg	~ 31											

[(*) supplied by inverter]

SP110.130.4H

Description	Unit of measurement	Value
Potenza nominale / rated power / nennleistung (S1)	kW	7.5
Corrente nominale / rated current / nennstrom (S1)	A	16
Tensione nominale concatenata / line rated voltage / nennspannung	V	380
Velocità nominale al carico nominale/ rated speed at rated load / nenn Drehzahl bei nennlast	Rpm	11910
Frequenza nominale / rated frequency / nennfrequenz	Hz	400
Tensione a vuoto concatenata / no-load line voltage / leerlaufspannung bei nennflussu	V	360
Corrente a vuoto / no-load current / leerlaufstrom	A	8.5
Resistenza dello statore / stator resistance / standerwiderstand kalt (20°C)	Ω	0.12
Resistenza del rotore /rotor resistance / lauferwiderstand kalt (20°C)	Ω	0.14
Reattanza di dispersione dello statore / stator leakage reactance / standerstreureaktanz	Ω	1.2
Reattanza di dispersione del rotore /rotor leakage reactance / lauferstreureaktanz	Ω	1.9
Reattanza del campo principale / main field reactance / hauptfeldreaktanz	Ω	25
Velocità di inizio indebolimento del campo / field weakening initial speed speed / Einsatzdrehzahl feldschwachung	Rpm	12000
Velocità massima del motore / motor maximum speed / Maximaldrehzahl	Rpm	20000
Fattore di potenza / power factor / nennleistungsfactor		0.85
Momento di inerzia del rotore / moment of inertia	Kg m2	1.8E-03
Collegamento / circuit connection / schaltungsart	Y or D	Y

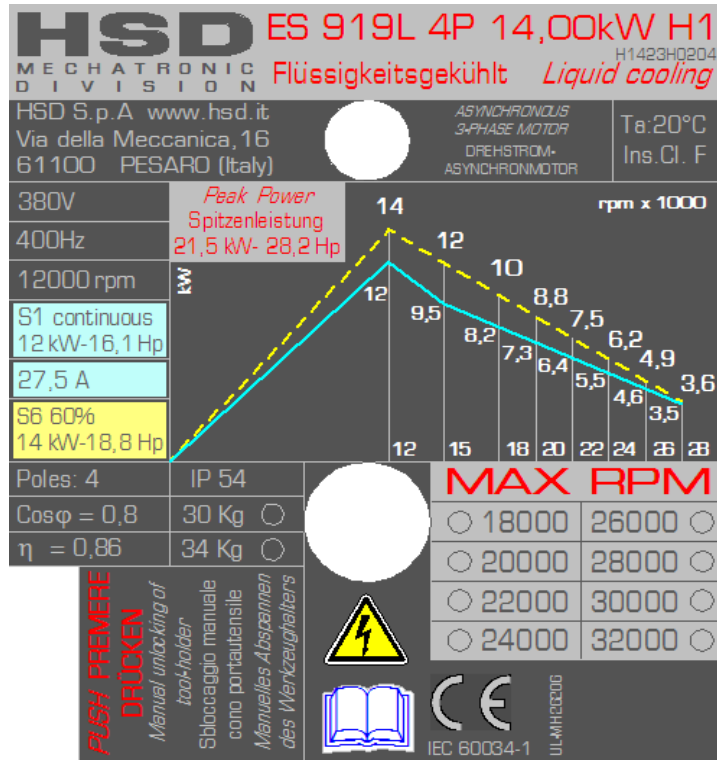

H1423H0204 Rev.01 (SP.110.130.48)																	
Rated voltage (*)	V	380		380		380		380		380		380		380		380	
Rated frequency	Hz	400		500		600		667		733		800		867		933	
Rated speed	rpm	12,000		15,000		18,000		20,000		22,000		24,000		26,000		28,000	
Duty type		S1 cont	S6 60%	S1 cont	S6 60%	S1 cont	S6 60%	S1 cont	S6 60%	S1 cont	S6 60%	S1 cont	S6 60%	S1 cont	S6 60%	S1 cont	S6 60%
Rated power	kW	12	14	9.5	12	8.2	10	7.3	8.8	6.4	7.5	5.5	6.2	4.6	4.9	3.5	3.6
Rated torque	Nm	9.5	11.1	6	7.6	4.6	5.3	3.5	4.2	2.8	3.3	2.2	2.5	1.7	1.8	1.2	1.2
Rated current	A	27.5	32	22	26.4	16.5	20	17	20.5	16.5	19	14	15.7	11.8	12.5	8.9	9.2
Rated output η		0.86															
Power factor cosφ		0.8															
Number of poles		4															
Type of insulation		F															
Type of cooling		Raffreddamento a liquido / Flüssigkeit / Liquid cooling															
Weight of SHORT NOSE version	kg	30															
Weight of LONG NOSE version	kg	34															

[(*) supplied by inverter]

SP110.130.48 (liquid-cooled)

Description	Unit of measurement	Value
Potenza nominale / rated power / nennleistung (S1)	kW	12
Corrente nominale / rated current / nennstrom (S1)	A	27.5
Tensione nominale concatenata / line rated voltage / nennspannung	V	380
Velocità nominale al carico nominale/ rated speed at rated load / nenn Drehzahl bei nennlast	Rpm	11760
Frequenza nominale / rated frequency / nennfrequenz	Hz	400
Tensione a vuoto concatenata / no-load line voltage / leerlaufspannung bei nennflussu	V	360
Corrente a vuoto / no-load current / leerlaufstrom	A	12
Resistenza dello statore / stator resistance / standerwiderstand kalt (20°C)	Ω	0.12
Resistenza del rotore /rotor resistance / lauferwiderstand kalt (20°C)	Ω	0.14
Reattanza di dispersione dello statore / stator leakage reactance / standerstreureaktanz	Ω	1.2
Reattanza di dispersione del rotore /rotor leakage reactance / lauferstreureaktanz	Ω	1.9
Reattanza del campo principale / main field reactance / hauptfeldreaktanz	Ω	25
Velocità di inizio indebolimento del campo / field weakening initial speed speed / Einsatzdrehzahl feldschwachung	Rpm	12000
Momento di inerzia del rotore / moment of inertia	Kg m²	1.8E-03
Collegamento / circuit connection / schaltungsart	Y or D	Y

2.10 TECHNICAL CARDS ES929

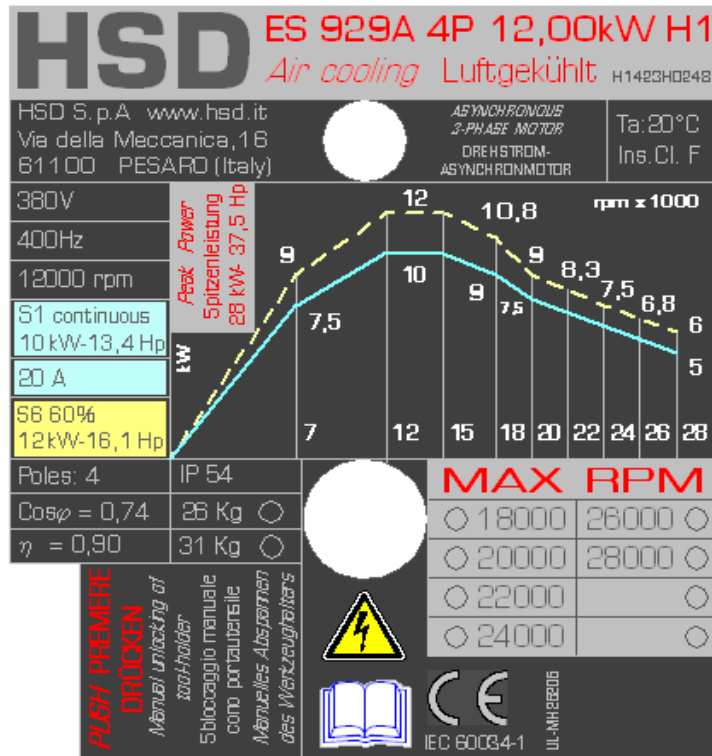

H1423H0248 Rev.04 (SP.110.131.43)																			
Rated voltage (*)	V	225	380	380	380	380	380	380	380	380	380	380	380	380	380	380	380	380	380
Rated frequency	Hz	233	400	500	600	667	733	800	867	933									
Rated speed	rpm	7000	12,000	15,000	18,000	20,000	22000	24,000	26000	28,000									
Duty type		S1 cont	S6 60%	S1 cont	S6 60%	S1 cont	S6 60%	S1 cont	S6 60%	S1 cont	S6 60%	S1 cont	S6 60%	S1 cont	S6 60%	S1 cont	S6 60%	S1 cont	S6 60%
Rated power	kW	7.5	9	10	12	10	12	9	10.8	7.5	9	6.8	8.3	6	7.5	5.8	6.8	5	6
Rated torque	Nm	10.2	12.3	8	9.6	6.3	7.6	4.8	5.7	3.6	4.3	3	3.6	2.4	3	2.1	2.5	1.7	2.1
Rated current	A	27	32.4	20	24	20	24	19	22.8	14.5	17.4	13.3	16	13	15.6	12.3	14.1	10.7	12.7
Rated output η		0.90																	
Power factor cosφ		0.74																	
Number of poles		4																	
Type of insulation		F																	
Type of cooling		Elettroventola / Elektrolüfter / Cooling fan																	
Weight of SHORT NOSE version	kg	~ 26																	
Weight of LONG NOSE version	kg	~ 31																	

[(*) supplied by inverter]

HSD

SP110.131.43 (air-cooled)

Description	Unit of measurement	Value
Potenza nominale / rated power / nennleistung (S1)	kW	10
Corrente nominale / rated current / nennstrom (S1)	A	22
Tensione nominale concatenata / line rated voltage / nennspannung	V	380
Velocità nominale al carico nominale/ rated speed at rated load / nenndrehzahl bei nennlast	Rpm	11930
Frequenza nominale / rated frequency / nennfrequenz	Hz	400
Tensione a vuoto concatenata / no-load line voltage / leerlaufspannung bei nennflussu	V	370
Corrente a vuoto / no-load current / leerlaufstrom	A	8.5
Resistenza dello statore / stator resistance / standerwiderstand kalt (20°C)	Ω	0.15
Resistenza del rotore /rotor resistance / lauferwiderstand kalt (20°C)	Ω	0.1
Reattanza di dispersione dello statore / stator leakage reactance / standerstreureaktanz	Ω	0.58
Reattanza di dispersione del rotore /rotor leakage reactance / lauferstreureaktanz	Ω	1
Reattanza del campo principale / main field reactance / hauptfeldreaktanz	Ω	25
Velocità di inizio indebolimento del campo / field weakening initial speed speed / Einsatzdrehzahl feldschwachung	Rpm	12000
Velocità massima del motore / motor maximum speed / Maximaldrehzahl	Rpm	20000
Fattore di potenza / power factor / nennleistungsfactor		0.7
Momento di inerzia del rotore / moment of inertia	Kg m ²	2.9E-03
Collegamento / circuit connection / schaltungsart	Y or D	Y

HSD

ES 929L 4P 18,00kW H1
H1423H0187
Flüssigkeitsgekühlt Liquid cooling

HSD S.p.A www.hsd.it
 Via della Meccanica, 16
 61100 PESARO (Italy)

ASYNCHRONOUS
3-PHASE MOTOR
DREHSTROM-
ASYNCHRONMOTOR

Ta: 20°C
Ins.Cl. F

380V	
400Hz	
12000 rpm	
S1 continuous 16 kW-21,5 Hp	
31 A	
S6 60% 18 kW-24,1 Hp	

MAX RPM

<input type="radio"/> 18000	<input type="radio"/> 26000
<input type="radio"/> 20000	<input type="radio"/> 28000
<input type="radio"/> 22000	<input type="radio"/>
<input type="radio"/> 24000	<input type="radio"/>

FUSH PREMIERE
 DRÜCKEN
 Manual unlocking of
 tool-holder
 Sbloccaggio manuale
 cono portautensile
 Manuelles Abstimmen
 des Werkzeughalters

IEC 60034-1
 UL-M186605

H1423H0187 Rev07 SP110.131.47																	
Rated voltage (*)	V	380		380		380		380		380		380		380		380	
Rated frequency	Hz	400		500		600		667		733		800		867		933	
Rated speed	rpm	12,000		15,000		18,000		20,000		22000		24,000		26000		28,000	
Duty type		S1 cont	S6 60%	S1 cont	S6 60%	S1 cont	S6 60%	S1 cont	S6 60%	S1 cont	S6 60%	S1 cont	S6 60%	S1 cont	S6 60%	S1 cont	S6 60%
Rated power	kW	16	18	14	16	12	14	10.8	12.7	9.5	11.3	8.2	10	7	8.7	5.6	7.3
Rated torque	Nm	12.7	14.3	8.9	10.2	6.4	7.4	5.2	6.1	4.1	4.9	3.3	4.0	2.6	3.2	1.9	2.5
Rated current	A	31	35.5	27.6	31	23	27	21	25	18.5	22	15.8	20	14	17	11	15
Rated output η		0.90															
Power factor $\cos\phi$		0.79															
Number of poles		4															
Type of insulation		F															
Type of cooling		Raffreddamento a liquido / Flüssigkeit / Liquid cooling															
Weight of SHORT NOSE version	kg	30															
Weight of LONG NOSE version	kg	34															

[(*) supplied by inverter]

SP110.131.47

Description	Unit of measurement	Value
Potenza nominale / rated power / nennleistung (S1)	kW	16
Corrente nominale / rated current / nennstrom (S1)	A	22
Tensione nominale concatenata / line rated voltage / nennspannung	V	380
Velocità nominale al carico nominale/ rated speed at rated load / nennzahl bei nennlast	Rpm	11920
Frequenza nominale / rated frequency / nennfrequenz	Hz	400
Tensione a vuoto concatenata / no load line voltage / leerlaufspannung bei nennfluss	V	373
Corrente a vuoto / no-load current / leerlaufstrom	A	7.7
Resistenza dello statore / stator resistance / standerwiderstand kalt (20°C)	Ω	0.15
Resistenza del rotore /rotor resistance / lauferwiderstand kalt (20°C)	Ω	0.08
Reattanza di dispersione dello statore / stator leakage reactance / standerstreureaktanz	Ω	0.6
Reattanza di dispersione del rotore /rotor leakage reactance / lauferstreureaktanz	Ω	1.1
Reattanza del campo principale / main field reactance / hauptfeldreaktanz	Ω	27.9
Velocità di inizio indebolimento del campo / field weakening initial speed speed / Einsatzdrehzahl feldschwachung	Rpm	12000
Velocità massima del motore / motor maximum speed / Maximaldrehzahl	Rpm	24000
Fattore di potenza / power factor / nennleistungsfactor		0.8
Momento di inerzia del rotore / moment of inertia	Kg m2	2.9E-03
Collegamento / circuit connection / schaltungsart	Y or D	Y

2.11 TECHNICAL CARDS ES939

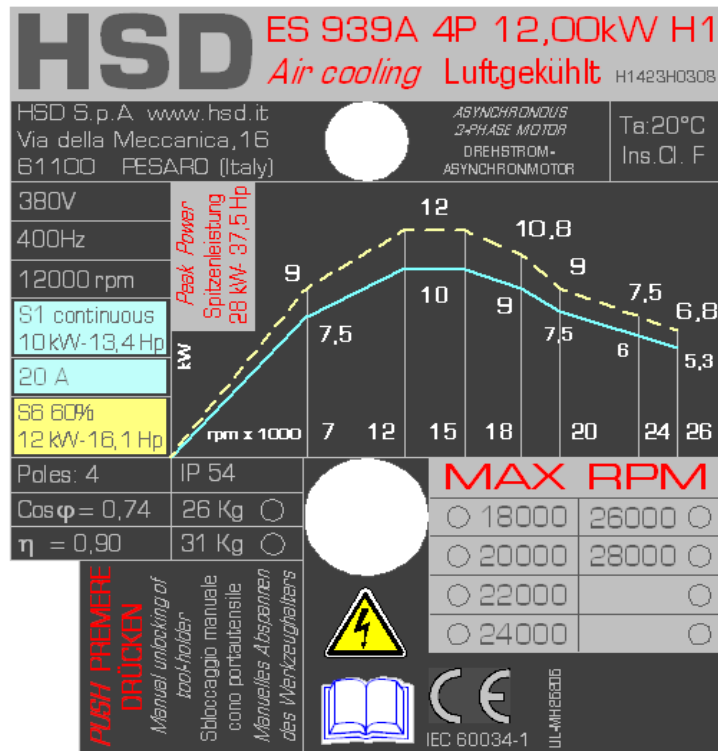

H1423H0308 Rev.P1 (SP.110.131.43)															
Rated voltage (*)	V	225		380		380		380		380		380		380	
Rated frequency	Hz	233		400		500		600		667		800		867	
Rated speed	rpm	7000		12,000		15,000		18,000		20,000		24,000		26000	
Duty type		S1 cont	S6 60%	S1 cont	S6 60%	S1 cont	S6 60%	S1 cont	S6 60%	S1 cont	S6 60%	S1 cont	S6 60%	S1 cont	S6 60%
Rated power	kW	7.5	9	10	12	10	12	9	10.8	7.5	9	6	7.5	5.3	6.8
Rated torque	Nm	10.2	12.3	8	9.6	6.3	7.6	4.8	5.7	3.6	4.3	2.4	3	1.9	2.5
Rated current	A	27	32.4	20	24	20	24	19	22.8	14.5	17.4	13	15.6	11.3	14.5
Rated output η		0.90													
Power factor cosφ		0.74													
Number of poles		4													
Type of insulation		F													
Type of cooling		Elettroventola / Elektrolüfter / Cooling fan													
Weight of HORT NOSE version	kg	~ 26													
Weight of ONG NOSE version	kg	~ 31													

[(*) supplied by inverter]

SP110.131.43 (air-cooled)

Description	Unit of measurement	Value
Potenza nominale / rated power / nennleistung (S1)	kW	10
Corrente nominale / rated current / nennstrom (S1)	A	22
Tensione nominale concatenata / line rated voltage / nennspannung	V	380
Velocità nominale al carico nominale/ rated speed at rated load / nenn Drehzahl bei nennlast	Rpm	11930
Frequenza nominale / rated frequency / nennfrequenz	Hz	400
Tensione a vuoto concatenata / no-load line voltage / leerlaufspannung bei nennflussu	V	370
Corrente a vuoto / no-load current / leerlaufstrom	A	8.5
Resistenza dello statore / stator resistance / standerwiderstand kalt (20°C)	Ω	0.15
Resistenza del rotore /rotor resistance / lauferwiderstand kalt (20°C)	Ω	0.1
Reattanza di dispersione dello statore / stator leakage reactance / standerstreureaktanz	Ω	0.58
Reattanza di dispersione del rotore /rotor leakage reactance / lauferstreureaktanz	Ω	1
Reattanza del campo principale / main field reactance / hauptfeldreaktanz	Ω	25
Velocità di inizio indebolimento del campo / field weakening initial speed speed / Einsatzdrehzahl feldschwachung	Rpm	12000
Velocità massima del motore / motor maximum speed / Maximaldrehzahl	Rpm	20000
Fattore di potenza / power factor / nennleistungsfactor		0.7
Momento di inerzia del rotore / moment of inertia	Kg m2	2.9E-03
Collegamento / circuit connection / schaltungsart	Y or D	Y

HSD

ES 939L 4P 18,00kW H1
H1423H03.09
Flüssigkeitsgekühlt Liquid cooling

HSD S.p.A www.hsd.it
 Via della Meccanica, 16
 61100 PESARO (Italy)

ASYNCHRONOUS 3-PHASE MOTOR
DREHSTROM-ASYNCHRONMOTOR

Ta: 20°C
Ins.Cl. F

380V	
400Hz	
12000 rpm	
S1 continuous 16 kW-21,5 Hp	
31 A	
S6 60% 18 kW-24,1 Hp	MAX RPM <input type="radio"/> 18000 <input type="radio"/> 28000 <input type="radio"/> 20000 <input type="radio"/> <input type="radio"/> 24000 <input type="radio"/> <input type="radio"/> 26000 <input type="radio"/>

Poles: 4 IP 54

Cosφ = 0,79 30 Kg

η = 0,90 34 Kg

PUSH / PREMERE
 DRÜCKEN

Manual unlocking of
 tool holder
 Sbloccaggio manuale
 capo portautensile
 Manuelles Abspannen
 des Werkzeughalters

IEC 60034-1 UL-MILWAUKEE

H1423H0309 RevP2 SP110.131.47											
Rated voltage (*)	V	380		380		380		380		380	
Rated frequency	Hz	400		600		667		800		867	
Rated speed	rpm	12,000		18,000		20,000		24,000		26000	
Duty type		S1 cont	S6 60%	S1 cont	S6 60%	S1 cont	S6 60%	S1 cont	S6 60%	S1 cont	S6 60%
Rated power	kW	16	18	12	14	10.8	12.7	8.2	10	7	8.7
Rated torque	Nm	12.7	14.3	6.4	7.4	5.2	6.1	3.3	4.0	2.6	3.2
Rated current	A	31	35.5	23	27	21	25	15.8	20	14	17
Rated output η		0.90									
Power factor cosφ		0.79									
Number of poles		4									
Type of insulation		F									
Type of cooling		Raffreddamento a liquido / Flüssigkeit / Liquid cooling									
Weight of SHORT NOSE version	kg	30									
Weight of LONG NOSE version	kg	34									

[(*) supplied by inverter]

SP110.131.47

Description	Unit of measurement	Value
Potenza nominale / rated power / nennleistung (S1)	kW	16
Corrente nominale / rated current / nennstrom (S1)	A	22
Tensione nominale concatenata / line rated voltage / nennspannung	V	380
Velocità nominale al carico nominale/ rated speed at rated load / nenn Drehzahl bei nennlast	Rpm	11920
Frequenza nominale / rated frequency / nennfrequenz	Hz	400
Tensione a vuoto concatenata / no-load line voltage / leerlaufspannung bei nennflussu	V	373
Corrente a vuoto / no-load current / leerlaufstrom	A	7.7
Resistenza dello statore / stator resistance / standerwiderstand kalt (20°C)	Ω	0.15
Resistenza del rotore /rotor resistance / lauferwiderstand kalt (20°C)	Ω	0.08
Reattanza di dispersione dello statore / stator leakage reactance / standerstreureaktanz	Ω	0.6
Reattanza di dispersione del rotore /rotor leakage reactance / lauferstreureaktanz	Ω	1.1
Reattanza del campo principale / main field reactance / hauptfeldreaktanz	Ω	27.9
Velocità di inizio indebolimento del campo / field weakening initial speed speed / Einsatzdrehzahl feldschwachung	Rpm	12000
Velocità massima del motore / motor maximum speed / Maximaldrehzahl	Rpm	24000
Fattore di potenza / power factor / nennleistungsfactor		0.8
Momento di inerzia del rotore / moment of inertia	Kg m2	2.9E-03
Collegamento / circuit connection / schaltungsart	Y or D	Y

HSD

ES 939A 4P 08,60kW H1
Air cooling Luftgekühlt H1423H0314

HSD S.p.A. www.hsd.it
 Via della Meccanica, 16
 61100 PESARO (Italy)

ASYNCHRONOUS
 3-PHASE MOTOR
 DREHSTROM-
 ASYNCHRONMOTOR

Ta: 20°C
 Ins. Cl. F

380V					
200Hz					
6000 rpm					
S1 continuous 7,5 kW-10,1 Hp					
15,5 A					
S6 60% 8,6 kW-11,5 Hp					<i>Peak Power</i> <i>Spitzenleistung</i> 13,5 kW-18,1 Hp

Poles: 4	IP 54				
Cosφ = 0,8	26 Kg		MAX RPM		
η = 0,88	31 Kg		<input type="radio"/> 18000	<input type="radio"/> 26000	<input type="radio"/>
			<input type="radio"/> 20000	<input type="radio"/> 28000	<input type="radio"/>
			<input type="radio"/> 22000	<input type="radio"/>	<input type="radio"/>
		IEC 60034-1	<input type="radio"/> 24000	<input type="radio"/>	<input type="radio"/>

HIGH PREMERE
DÜCKEN

Manual unlocking of
tool-holder
Subocaggio manuale
cono portautensile
Manuelles Absperren
des Werkzeughalters

UL-MHEB206

H1423H0314 Rev.01 (SP.110.131.48)									
Rated voltage (*)	V	380		380		380		380	
Rated frequency	Hz	200		400		600		800	
Rated speed	rpm	6000		12,000		18,000		24,000	
Duty type		S1 cont	S6 60%	S1 cont	S6 60%	S1 cont	S6 60%	S1 cont	S6 60%
Rated power	kW	7.5	8.6	7.0	8.1	5.5	6.3	4.5	5.2
Rated torque	Nm	11.9	13.7	5.6	6.4	2.9	3.3	1.8	2.1
Rated current	A	15.5	17.8	15.0	19.3	11.5	13.2	10.0	11.5
Rated output η		0.88		0.86		0.80		0.75	
Power factor cosφ		0.8							
Number of poles		4							
Type of insulation		F							
Type of cooling		Elettroventola / Elektrolüfter / Cooling fan							
Weight of SHORT NOSE version	kg	~ 26							
Weight of LONG NOSE version	kg	~ 31							

[(*) supplied by inverter]

SP110.131.48

Description	Unit of measurement	Value
Potenza nominale / rated power / nennleistung (S1)	kW	9
Corrente nominale / rated current / nennstrom (S1)	A	24
Tensione nominale concatenata / line rated voltage / nennspannung	V	380
Velocità nominale al carico nominale/ rated speed at rated load / nenn Drehzahl bei nennlast	Rpm	5850
Frequenza nominale / rated frequency / nennfrequenz	Hz	200
Tensione a vuoto concatenata / no-load line voltage / leerlaufspannung bei nennflussu	V	370
Corrente a vuoto / no-load current / leerlaufstrom	A	5.6
Resistenza dello statore / stator resistance / standerwiderstand kalt (20°C)	Ω	0.5
Resistenza del rotore /rotor resistance / lauferwiderstand kalt (20°C)	Ω	0.48
Reattanza di dispersione dello statore / stator leakage reactance / standerstreureaktanz	Ω	1.0
Reattanza di dispersione del rotore /rotor leakage reactance / lauferstreureaktanz	Ω	1.7
Reattanza del campo principale / main field reactance / hauptfeldreaktanz	Ω	38.2
Velocità di inizio indebolimento del campo / field weakening initial speed speed / Einsatzdrehzahl feldschwachung	Rpm	6000
Velocità massima del motore / motor maximum speed / Maximaldrehzahl	Rpm	18000
Fattore di potenza / power factor / nennleistungsfactor		0.8
Collegamento / circuit connection / schaltungsart	Y or D	Y

HSD

ES 939L 4P 10,00kW H1
H1423H0317
Flüssigkeitsgekühlt Liquid cooling

HSD S.p.A www.hsd.it
 Via della Meccanica, 16
 61100 PESARO (Italy)

ASYNCHRONOUS
 3-PHASE MOTOR
 DREHSTROM-
 ASYNCHRONMOTOR

Ta: 20°C
 Ins.Cl. F

380V
200Hz
6000 rpm
S1 continuous 9 kW-12,1 Hp
18,6 A
S6 40% 10 kW-13,4 Hp

Peak Power Spitzenleistung 13,5 kW-18,1 Hp	
---	--

Poles: 4	IP 54	MAX RPM	
cosφ = 0,8	30 Kg ○	<input type="radio"/> 18000	<input type="radio"/> 26000
η = 0,88	34 Kg ○	<input type="radio"/> 20000	<input type="radio"/> 28000
		<input type="radio"/> 22000	<input type="radio"/>
		<input type="radio"/> 24000	<input type="radio"/>

FUSH PREMERE
 DRÜCKEN

Manual unclacking of
 tool-holder

Sbloccaggio manuale
 cono portautensile

Manuelles Abspannen
 des Werkzeughalters

IEC 60034-1

H1423H0317 Rev.00 (SP.110.131.48)									
Rated voltage (*)	V	380		380		380		380	
Rated frequency	Hz	200		400		600		800	
Rated speed	rpm	6000		12,000		18,000		24,000	
Duty type		S1 cont	S6 40%	S1 cont	S6 40%	S1 cont	S6 40%	S1 cont	S6 40%
Rated power	kW	9	10	8	9	6	6.5	4.5	5.2
Rated torque	Nm	14.3	15.9	6.4	7.2	3.2	3.4	1.8	2.1
Rated current	A	18.6	20.7	17.1	21.7	12.7	13.6	10	11.5
Rated output η		0.88		0.86		0.80		0.75	
Power factor cosφ		0.8							
Number of poles		4							
Type of insulation		F							
Type of cooling		Raffreddamento a liquido / Flüssigkeit / Liquid cooling							
Weight of SHORT NOSE version	kg	~ 30							
Weight of LONG NOSE version	kg	~ 34							

[(*) supplied by inverter]

SP110.131.48

Description	Unit of measurement	Value
Potenza nominale / rated power / nennleistung (S1)	kW	9
Corrente nominale / rated current / nennstrom (S1)	A	24
Tensione nominale concatenata / line rated voltage / nennspannung	V	380
Velocità nominale al carico nominale/ rated speed at rated load / nenndrehzahl bei nennlast	Rpm	5850
Frequenza nominale / rated frequency / nennfrequenz	Hz	200
Tensione a vuoto concatenata / no-load line voltage / leerlaufspannung bei nennflussu	V	370
Corrente a vuoto / no-load current / leerlaufstrom	A	5.6
Resistenza dello statore / stator resistance / standerwiderstand kalt (20°C)	Ω	0.5
Resistenza del rotore /rotor resistance / lauferwiderstand kalt (20°C)	Ω	0.48
Reattanza di dispersione dello statore / stator leakage reactance / standerstreureaktanz	Ω	1.0
Reattanza di dispersione del rotore /rotor leakage reactance / lauferstreureaktanz	Ω	1.7
Reattanza del campo principale / main field reactance / hauptfeldreaktanz	Ω	38.2
Velocità di inizio indebolimento del campo / field weakening initial speed speed / Einsatzdrehzahl feldschwachung	Rpm	6000
Velocità massima del motore / motor maximum speed / Maximaldrehzahl	Rpm	18000
Fattore di potenza / power factor / nennleistungsfactor		0.8
Collegamento / circuit connection / schaltungsart	Y or D	Y

2.12 TECHNICAL CARDS ES983

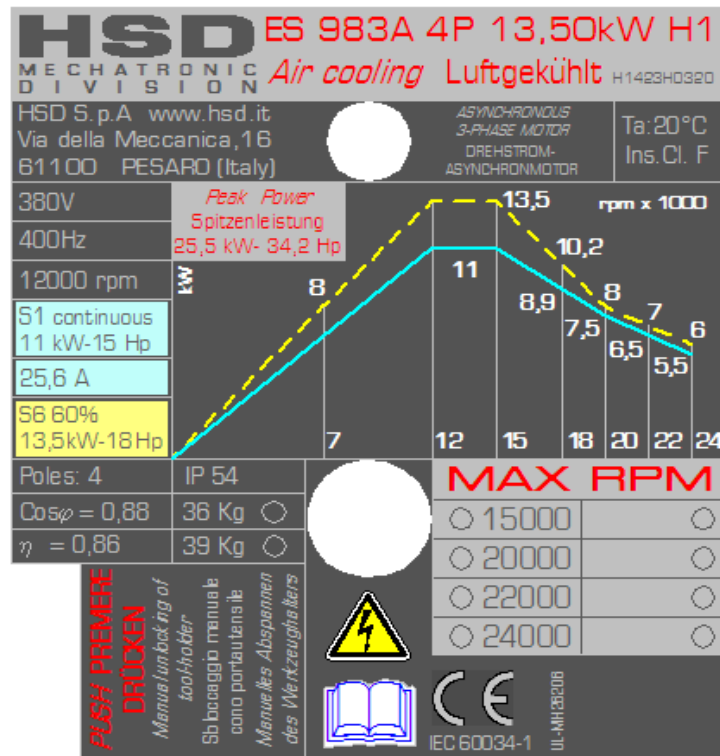

1423H0320 Rev.01 (SP.120.150.45)															
Rated voltage (*)	V	225	380	380	380	380	380	380	380	380	380	380	380	380	380
Rated frequency	Hz	233	400	500	600	667	733	800							
Rated speed	rpm	7000	12,000	15,000	18,000	20,000	22000	24,000							
Duty type		S6 60%	S1 cont	S6 60%	S1 cont	S6 60%	S1 cont	S6 60%	S1 cont	S6 60%	S1 cont	S6 60%	S1 cont	S6 60%	S1 cont
Rated power	kW	8	11	13.5	11	13.5	8.9	10.2	7.5	8	6.5	7	5.5	6	
Rated torque	Nm	10.9	8.8	10.7	7.0	8.6	4.7	5.4	3.6	3.8	2.8	3	2.2	2.4	
Rated current	A	32	25.6	31.5	26.2	32	25.4	30	18.6	19.8	17.5	21.8	14	17.4	
Rated output η		0.86													
Power factor cosφ		0.88													
Number of poles		4													
Type of insulation		F													
Type of cooling		Elettroventola / Elektrolüfter / Cooling fan													
Weight of SHORT NOSE version	kg	~ 36													
Weight of LONG NOSE version	kg	~ 39													

[(*) supplied by inverter]

HSD

SP110.150.45 (air-cooled)

Description	Unit of measurement	Value
Potenza nominale / rated power / nennleistung (S1)	kW	11
Corrente nominale / rated current / nennstrom (S1)	A	25.6
Tensione nominale concatenata / line rated voltage / nennspannung	V	380
Velocità nominale al carico nominale/ rated speed at rated load / nennndrehzahl bei nennlast	Rpm	11784
Frequenza nominale / rated frequency / nennfrequenz	Hz	400
Tensione a vuoto concatenata / no load line voltage / leerlaufspannungbei nennflussu	V	364
Corrente a vuoto / no-load current / leerlaufstrom	A	9.5
Resistenza dello statore / stator resistance / standerwiderstand kalt (20°C)	Ω	0.09
Resistenza del rotore /rotor resistance / lauferwiderstand kalt (20°C)	Ω	0.13
Reattanza di dispersione dello statore / stator leakage reactance / standerstreureaktanz	Ω	0.61
Reattanza di dispersione del rotore /rotor leakage reactance / lauferstreureaktanz	Ω	1.8
Reattanza del campo principale / main field reactance / hauptfeldreaktanz	Ω	27.9
Velocità di inizio indebolimento del campo / field weakening initial speed speed / Einsatzdrehzahl feldschwachung	Rpm	12000
Fattore di potenza / power factor / nennleistungsfactor		0.8
Momento di inerzia del rotore / moment of inertia	Kg m2	2.5E-03
Collegamento / circuit connection / schaltungsart	Y or D	Y

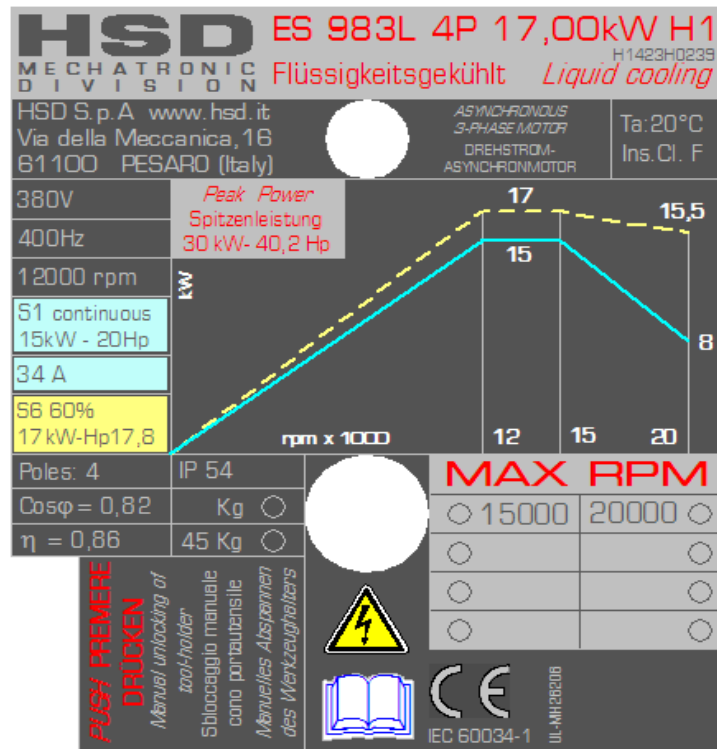

1423H0239 Rev.00 (SP120.150.45L)							
Rated voltage (*)	V	380		380		380	
Rated frequency	Hz	400		500		667	
Rated speed	rpm	12,000		15,000		20,000	
Duty type		S1 cont	S6 60%	S1 cont	S6 60%	S1 cont	S6 60%
Rated power	kW	15	17	15	17	8	15.5
Rated torque	Nm	12	13.5	9.6	10.8	3.8	7.4
Rated current	A	34	40	34	40	19	39
Rated output η		0.86					
Power factor cosφ		0.82					
Number of poles		4					
Type of insulation		F					
Type of cooling		Raffreddamento a liquido / Flüssigkeit / Liquid cooling					
Weight of LONG NOSE version	kg	~ 45					
[(*) supplied by inverter]							

HSD

SP110.150.45 (liquid-cooled)

Description	Unit of measurement	Value
Potenza nominale / rated power / nennleistung (S1)	kW	15
Corrente nominale / rated current / nennstrom (S1)	A	34
Tensione nominale concatenata / line rated voltage / nennspannung	V	380
Velocità nominale al carico nominale/ rated speed at rated load / nenn Drehzahl bei nennlast	Rpm	11748
Frequenza nominale / rated frequency / nennfrequenz	Hz	400
Tensione a vuoto concatenata / no load line voltage / leerlaufspannung bei nennfluss	V	364
Corrente a vuoto / no-load current / leerlaufstrom	A	9.5
Resistenza dello statore / stator resistance / standerwiderstand kalt (20°C)	Ω	0.09
Resistenza del rotore / rotor resistance / lauferwiderstand kalt (20°C)	Ω	0.13
Reattanza di dispersione dello statore / stator leakage reactance / standerstreureaktanz	Ω	0.61
Reattanza di dispersione del rotore / rotor leakage reactance / lauferstreureaktanz	Ω	1.8
Reattanza del campo principale / main field reactance / hauptfeldreaktanz	Ω	27.9
Velocità di inizio indebolimento del campo / field weakening initial speed speed / Einsatzdrehzahl feldschwachung	Rpm	12000
Fattore di potenza / power factor / nennleistungsfactor		0.8
Momento di inerzia del rotore / moment of inertia	Kg m2	2.5E-03
Collegamento / circuit connection / schaltungsart	Y or D	Y

HSD

ES 983L 4P 18,00kW H1
H 1423H 0262
 Flüssigkeitsgekühlt *Liquid cooling*

HSD S.p.A. www.hsd.it
 Via della Meccanica, 18
 B1100 PESARO (Italy)

ASYNCHRONOUS 3-PHASE MOTOR
DREHSTROM-ASYNCHRONMOTOR

Ta: 20°C
Ins.Cl. F

380V											
267Hz											
8000 rpm											
S1 continuous 16 kW-21,5 Hp											
34,5 A											
S6 60% 18 kW-24,1 Hp											

Poles: 4	IP 54	MAX RPM	
cosφ = 0,7	Kg ○	<input type="radio"/> 15000	<input type="radio"/>
η = 0,8	45 Kg ○	<input type="radio"/> 18000	<input type="radio"/>
		<input type="radio"/> 22000	<input type="radio"/>
		<input type="radio"/>	<input type="radio"/>

FLASH PREMIERE
INTELLIGENT

Manual Unlocking of tool-holder
Sbloccaggio manuale con portautensile
Manuelles Abspannen des Werkzeughalters

IEC 60034-1 U.L. NH 983.05

H1423H0262 Rev.02 (SP 120.150.4A)											
Rated voltage (*)	V	380		380		380		380		380	
Rated frequency	Hz	267		333		500		600		733	
Rated speed	rpm	8,000		10000		15,000		18,000		22000	
Duty type		S1 cont	S6 60%	S1 cont	S6 60%	S1 cont	S6 60%	S1 cont	S6 60%	S1 cont	S6 60%
Rated power	kW	16.0	18.0	16.0	18.0	11.0	13.0	8.0	10.0	4.3	5.2
Rated torque	Nm	19	21.5	15.3	17.2	7.0	8.3	4.2	5.3	1.9	2.3
Rated current	A	34.5	45	34.5	45	23.7	32.6	18.0	26.0	8.0	11.0
Rated output η		0.8									
Power factor cos φ		0.7									
Number of poles		4.0									
Type of insulation		F									
IP rating		54									
Type of cooling		Raffreddamento a liquido / Flüssigkeit / Liquid cooling									
Weight of LONG NOSE version	kg	~ 45									
[(*) supplied by inverter]											

HSD

SP120.150.4A

Description	Unit of measurement	Value
Potenza nominale / rated power / nennleistung (S1)	kW	16
Corrente nominale / rated current / nennstrom (S1)	A	34.5
Tensione nominale concatenata / line rated voltage / nennspannung	V	380
Velocità nominale al carico nominale/ rated speed at rated load / nenndrehzahl bei nennlast	Rpm	7810
Frequenza nominale / rated frequency / nennfrequenz	Hz	267
Tensione a vuoto concatenata / no load line voltage / leerlaufspannungbei nennflussu	V	266
Corrente a vuoto / no-load current / leerlaufstrom	A	11
Resistenza dello statore / stator resistance / standerwiderstand kalt (20°C)	Ω	0.12
Resistenza del rotore /rotor resistance / lauferwiderstand kalt (20°C)	Ω	0.2
Reattanza di dispersione dello statore / stator leakage reactance / standerstreureaktanz	Ω	1
Reattanza di dispersione del rotore /rotor leakage reactance / lauferstreureaktanz	Ω	1.7
Reattanza del campo principale / main field reactance / hauptfeldreaktanz	Ω	19
Velocità di inizio indebolimento del campo / field weakening initial speed speed / Einsatzdrehzahl feldschwachung	Rpm	8000
Velocità massima del motore / motor maximum speed / Maximaldrehzahl	Rpm	18000
Fattore di potenza / power factor / nennleistungsfactor		0.8
Momento di inerzia del rotore / moment of inertia	Kg m2	0,0025
Collegamento / circuit connection / schaltungsart	Y or D	Y

HSD

ES 988A 4P 08,00kW H1
Air cooling Luftgekühlt

H1423H0334
ASYNCHRONOUS
3-PHASE MOTOR
DREHSTROM-
ASYNCHRONMOTOR

HSD S.p.A www.hsd.it
 Via della Meccanica, 16
 61100 PESARO (Italy)

Ta: 20°C
 Ins. Cl. F

220V	440V
200Hz	
6000 rpm	
S1 continuous 7,0 kW-9,5 Hp	
28 A	14 A
S6 60% 8,0 kW-10,8 Hp	

<i>Peak Power Spitzenleistung 11,5kW - 15,6 Hp</i>	
--	--

Poles: 4	IP 54
cosφ = 0,82	Kg ○
η = 0,88	39 Kg ○

MAX RPM	
○ 12000	○ 24000 ○
○	○
○	○
○	○

IEC 60034-1

H1423H0334 Rev.P1 (SP.120.150.4Q)									
Rated voltage (*)	V	220	220	440	440				
Rated frequency	Hz	200	400	200	400				
Rated speed	rpm	6000	12,000	6000	12,000				
Duty type		S1 cont	S6 60%	S1 cont	S6 60%	S1 cont	S6 60%	S1 cont	S6 60%
Rated power	kW	7	8	5	6	7	8	5	6
Rated torque	Nm	11.1	12.7	8	8.2	11.1	12.7	8	8.2
Rated current	A	28	32	21	26	14	16	10.5	13
Rated output η		0.88							
Power factor cosφ		0.82							
Number of poles		4							
Type of insulation		F							
Type of cooling		<i>Raffreddamento a liquido / Flüssigkeit / Liquid cooling</i>							
Weight of LONG NOSE version	kg	39							

[(*) supplied by inverter]

HSD

SP120.150.4Q (with 440V connection)

Description	Unit of measurement	Value
Potenza nominale / rated power / nennleistung (S1)	kW	5.5
Corrente nominale / rated current / nennstrom (S1)	A	10.4
Tensione nominale concatenata / line rated voltage / nennspannung	V	440
Velocità nominale al carico nominale/ rated speed at rated load / nenn Drehzahl bei nennlast	Rpm	5890
Frequenza nominale / rated frequency / nennfrequenz	Hz	200
Tensione a vuoto concatenata / no load line voltage / leerlaufspannung bei nennfluss	V	431
Corrente a vuoto / no-load current / leerlaufstrom	A	4
Resistenza dello statore / stator resistance / standerwiderstand kalt (20°C)	Ω	0.43
Resistenza del rotore / rotor resistance / lauferwiderstand kalt (20°C)	Ω	0.57
Reattanza di dispersione dello statore / stator leakage reactance / standerstreureaktanz	Ω	1.9
Reattanza di dispersione del rotore / rotor leakage reactance / lauferstreureaktanz	Ω	6.0
Reattanza del campo principale / main field reactance / hauptfeldreaktanz	Ω	61.2
Velocità di inizio indebolimento del campo / field weakening initial speed speed / Einsatzdrehzahl feldschwachung	Rpm	6000
Velocità massima del motore / motor maximum speed / Maximaldrehzahl	Rpm	12000
Fattore di potenza / power factor / nennleistungsfactor		0.82
Momento di inerzia del rotore / moment of inertia	Kg m2	2.5E-03
Collegamento / circuit connection / schaltungsart	Y or D	Y

HSD

SP120.150.4Q (with 220V connection)

Description	Unit of measurement	Value
Potenza nominale / rated power / nennleistung (S1)	kW	5.5
Corrente nominale / rated current / nennstrom (S1)	A	20.8
Tensione nominale concatenata / line rated voltage / nennspannung	V	220
Velocità nominale al carico nominale/ rated speed at rated load / nenn Drehzahl bei nennlast	Rpm	5890
Frequenza nominale / rated frequency / nennfrequenz	Hz	200
Tensione a vuoto concatenata / no load line voltage / leerlaufspannung bei nennfluss	V	215
Corrente a vuoto / no-load current / leerlaufstrom	A	7.9
Resistenza dello statore / stator resistance / standerwiderstand kalt (20°C)	Ω	0.11
Resistenza del rotore / rotor resistance / lauferwiderstand kalt (20°C)	Ω	0.14
Reattanza di dispersione dello statore / stator leakage reactance / standerstreureaktanz	Ω	0.7
Reattanza di dispersione del rotore / rotor leakage reactance / lauferstreureaktanz	Ω	1.5
Reattanza del campo principale / main field reactance / hauptfeldreaktanz	Ω	15.5
Velocità di inizio indebolimento del campo / field weakening initial speed speed / Einsatzdrehzahl feldschwachung	Rpm	6000
Velocità massima del motore / motor maximum speed / Maximaldrehzahl	Rpm	12000
Fattore di potenza / power factor / nennleistungsfactor		0.82
Momento di inerzia del rotore / moment of inertia	Kg m2	2.5E-03
Collegamento / circuit connection / schaltungsart	Y or D	YY

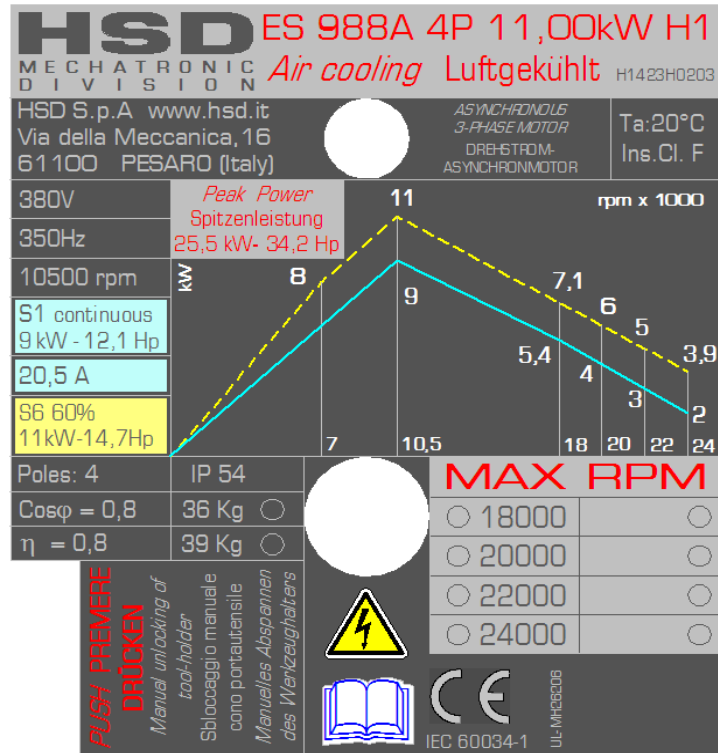

H1423H0203 Rev.01 (SP.120.150.49)													
Rated voltage (*)	V	255		380		380		380		380		380	
Rated frequency	Hz	233		350		600		667		733		800	
Rated speed	rpm	7000		10,500		18,000		20,000		22000		24,000	
Duty type		S1 cont	S6 60%	S1 cont	S6 60%	S1 cont	S6 60%	S1 cont	S6 60%	S1 cont	S6 60%	S1 cont	S6 60%
Rated power	kW		8	9	11	5.4	7.1	4	6	3	5	2	3.9
Rated torque	Nm		10.9	8.2	10	2.9	3.8	1.9	2.9	1.3	2.2	0.8	1.6
Rated current	A		27.5	20.5	25	12	15.6	12	18.5	9	15.5	6	12
Rated output η		0.8											
Power factor cosφ		0.8											
Number of poles		4											
Type of insulation		F											
Type of cooling		<i>Elettroventola / Elektrolüfter / Cooling fan</i>											
Weight of SHORT NOSE version	kg	~ 36											
Weight of LONG NOSE version	kg	~ 39											

[(*) supplied by inverter]

SP120.150.49

Description	Unit of measurement	Value
Potenza nominale / rated power / nennleistung (S1)	kW	11
Corrente nominale / rated current / nennstrom (S1)	A	27.5
Tensione nominale concatenata / line rated voltage / nennspannung	V	380
Velocità nominale al carico nominale/ rated speed at rated load / nennzahl bei nennlast	Rpm	10350
Frequenza nominale / rated frequency / nennfrequenz	Hz	350
Tensione a vuoto concatenata / no load line voltage / leerlaufspannung bei nennflussu	V	380
Corrente a vuoto / no-load current / leerlaufstrom	A	6.0
Resistenza dello statore / stator resistance / standerwiderstand kalt (20°C)	Ω	0.14
Resistenza del rotore /rotor resistance / lauferwiderstand kalt (20°C)	Ω	0.22
Reattanza di dispersione dello statore / stator leakage reactance / standerstreureaktanz	Ω	1.1
Reattanza di dispersione del rotore /rotor leakage reactance / lauferstreureaktanz	Ω	1.8
Reattanza del campo principale / main field reactance / hauptfeldreaktanz	Ω	38
Velocità di inizio indebolimento del campo / field weakening initial speed speed / Einsatzdrehzahl feldschwachung	Rpm	10500
Velocità massima del motore / motor maximum speed / Maximaldrehzahl	Rpm	20000
Fattore di potenza / power factor / nennleistungsfactor		0.8
Momento di inerzia del rotore / moment of inertia	Kg m2	2.5E-03
Collegamento / circuit connection / schaltungsart	Y or D	D

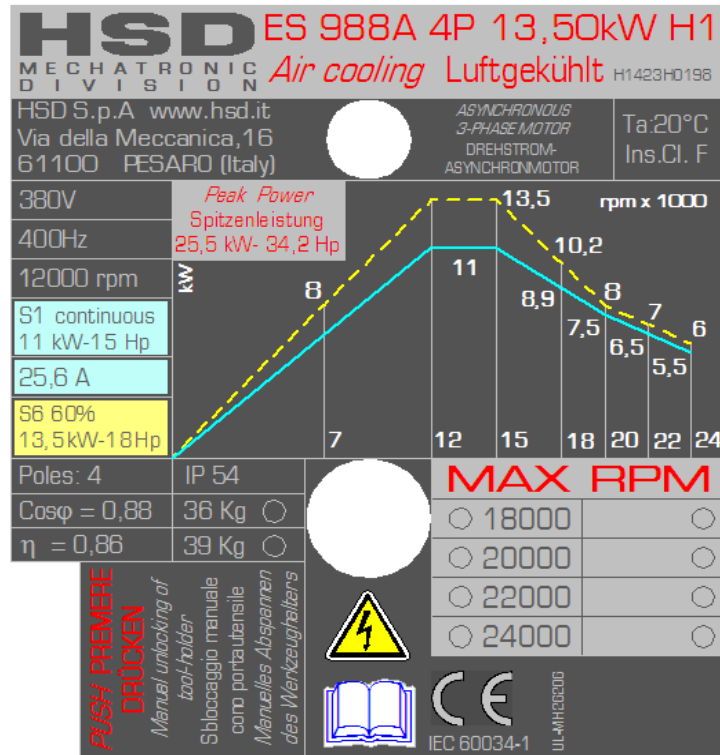

1423H0198 Rev.00 (SP.120.150.45)														
Rated voltage (*)	V	225	380	380	380	380	380	380	380	380	380	380	380	380
Rated frequency	Hz	233	400	500	600	667	733	800						
Rated speed	rpm	7000	12,000	15,000	18,000	20,000	22000	24,000						
Duty type		S6 60%	S1 cont	S6 60%	S1 cont	S6 60%	S1 cont	S6 60%	S1 cont	S6 60%	S1 cont	S6 60%	S1 cont	S6 60%
Rated power	kW	8	11	13.5	11	13.5	8.9	10.2	7.5	8	6.5	7	5.5	6
Rated torque	Nm	10.9	8.8	10.7	7.0	8.6	4.7	5.4	3.6	3.8	2.8	3	2.2	2.4
Rated current	A	32	25.6	31.5	26.2	32	25.4	30	18.6	19.8	17.5	21.8	14	17.4
Rated output η		0.86												
Power factor cosφ		0.88												
Number of poles		4												
Type of insulation		F												
Type of cooling		Elettroventola / Elektrolüfter / Cooling fan												
Weight of SHORT NOSE version	kg	~ 36												
Weight of LONG NOSE version	kg	~ 39												

[(*) supplied by inverter]

HSD

SP110.150.45 (air-cooled)

Description	Unit of measurement	Value
Potenza nominale / rated power / nennleistung (S1)	kW	11
Corrente nominale / rated current / nennstrom (S1)	A	25.6
Tensione nominale concatenata / line rated voltage / nennspannung	V	380
Velocità nominale al carico nominale/ rated speed at rated load / nenn Drehzahl bei nennlast	Rpm	11784
Frequenza nominale / rated frequency / nennfrequenz	Hz	400
Tensione a vuoto concatenata / no load line voltage / leerlaufspannung bei nennflussu	V	364
Corrente a vuoto / no-load current / leerlaufstrom	A	9.5
Resistenza dello statore / stator resistance / standerwiderstand kalt (20°C)	Ω	0.09
Resistenza del rotore /rotor resistance / lauferwiderstand kalt (20°C)	Ω	0.13
Reattanza di dispersione dello statore / stator leakage reactance / standerstreureaktanz	Ω	0.61
Reattanza di dispersione del rotore /rotor leakage reactance / lauferstreureaktanz	Ω	1.8
Reattanza del campo principale / main field reactance / hauptfeldreaktanz	Ω	27.9
Velocità di inizio indebolimento del campo / field weakening initial speed speed / Einsatzdrehzahl feldschwachung	Rpm	12000
Fattore di potenza / power factor / nennleistungsfactor		0.8
Momento di inerzia del rotore / moment of inertia	Kg m2	2.5E-03
Collegamento / circuit connection / schaltungsart	Y or D	Y

3 TRANSPORT, PACKAGING, UNPACKING, STORAGE

3.1 WARNINGS

- The lifting and handling of the product may create hazardous situations for the persons involved; we therefore recommend that the instructions given by HSD S.p.A. are observed and that only suitable tools are used.
- The installation and assembly operations must always be carried out by specialised technicians only.
- We recommend that all lifting and handling operations of the product or its parts be carried out with great care, avoiding collisions that could compromise the proper functioning, or damage coated parts.



The user is responsible for selecting the lifting equipment (ropes, straps or chains, etc.) considered most suitable in terms of both functionality and lifting capacity, with regard to the weight indicated on the packaging and on the product label.

3.2 DIMENSIONS AND WEIGHTS

- Weight of the packed product: indicated on the packing.
- Linear dimensions of the packaging: shown in the accompanying documents.

3.3 TRANSPORT AND PACKAGING CONDITIONS

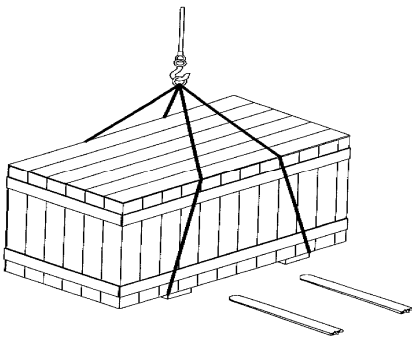

The product is shipped protected by a covering of VCI plastic and expanded foam, packed in a wooden crate or case of special cardboard.

The figure shows a few methods of lifting the packed product (using ropes and a fork-lift truck; in the latter case, ensure that during lifting the centre of gravity of the crate is always between the two forks).

The examples shown are only indications, as it is not possible to determine in advance all the possible configurations for lifting a product manufactured by HSD S.p.A.

3.4 UNPACKING PROCEDURE



Check the integrity of the seals on the packaging before opening it.

If the product is packed in a wooden crate, insert a screwdriver under the locking hook. Lever it open, paying attention not to damage the packaging and its contents.

If the product is packed in a cardboard case, remove the strip of adhesive tape, paying attention not to damage the packaging and its contents.



Do not lift the product by pulling on the part of the electric fan, in order not to damage the guard.



The expanded foam and plastic cover can be disposed of as plastic material.

3.5 STORAGE

If the product is to be stored, it must be protected against the weather, moisture, dust and aggressive atmospheric and environmental agents.

It is therefore necessary:

- to carry out periodic checks to ensure the good general condition of conservation;
- to manually rotate the shaft (roughly once a month) to maintain optimum lubrication of the bearings.

STORAGE TEMPERATURE: from 5°C (+41°F) to +55°C (+131°F)

RELATIVE HUMIDITY (NON-CONDENSING): from 5% to 55%



Maximum storage time for an HSD product is 12 months.

Beyond this limit it is necessary to review the state of the product.

For further information contact HSD Customer Service (see section **Errore. L'origine riferimento non è stata trovata.**).

4 INSTALLATION AND INITIAL START-UP

4.1 CHECK

Before carrying out any operations, CHECK:

- that no part of the electrospindle has been damaged during transport and/or handling;
- that connectors are not damaged.

4.2 PREPARATION OF THE AUXILIARY SYSTEMS OF THE PLANT

The preparatory work (e.g. providing electricity, air systems etc.) is the responsibility of the customer.

The electric power lead of the electrospindle must have the necessary transmission power. The connection to the electricity mains supply must be carried out by qualified personnel. You are reminded that the customer is responsible for all the electricity supply as far as the connectors of the electrospindle.

The customer is also reminded of the need to provide all the safety conditions necessary for the "earthing" of the electrospindle.

The earthing system must conform to the standards in force in the country of installation and must be inspected at regular intervals by qualified personnel.

For the connections, see the sections below.

4.3 MECHANICAL CONNECTIONS

4.3.1 Positioning of electrospindle (versions with electric fan)

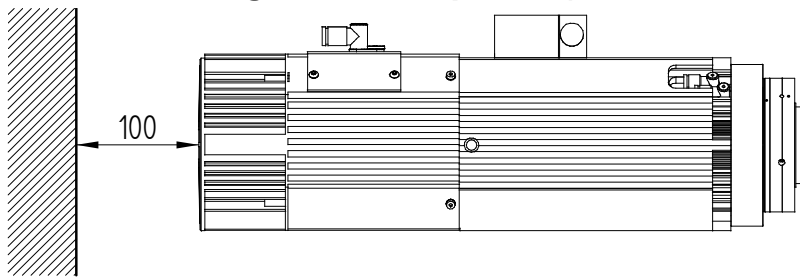

Figure4 .1 Minimum clearance of the fan

When choosing the location for the electrospindle, ensure a clearance of at least 100mm from the grille of the electric fan, so as not to obstruct the flow of cooling air.



IP protection rating of the electric fan: 21; (IP protection rating of the electrospindle: 54).
Ensure that the electric fan sucks in sufficient air for its IP protection rating, as otherwise it may be damaged.



4.3.2 Electrospindle resting surface (versions with rectangular framework)

i The resting surface where the electrospindle is fixed must have a planarity of less than 0.02mm.

	0,02
---	------

4.3.3 Fixing structure for spindles with round framework

i The fixing structure on which the electrospindle is to be fitted must have a planarity of less than 0.015mm, and a perpendicularity with respect to the spindle axis of less than 0.015mm

	0,015	
	A	0,015

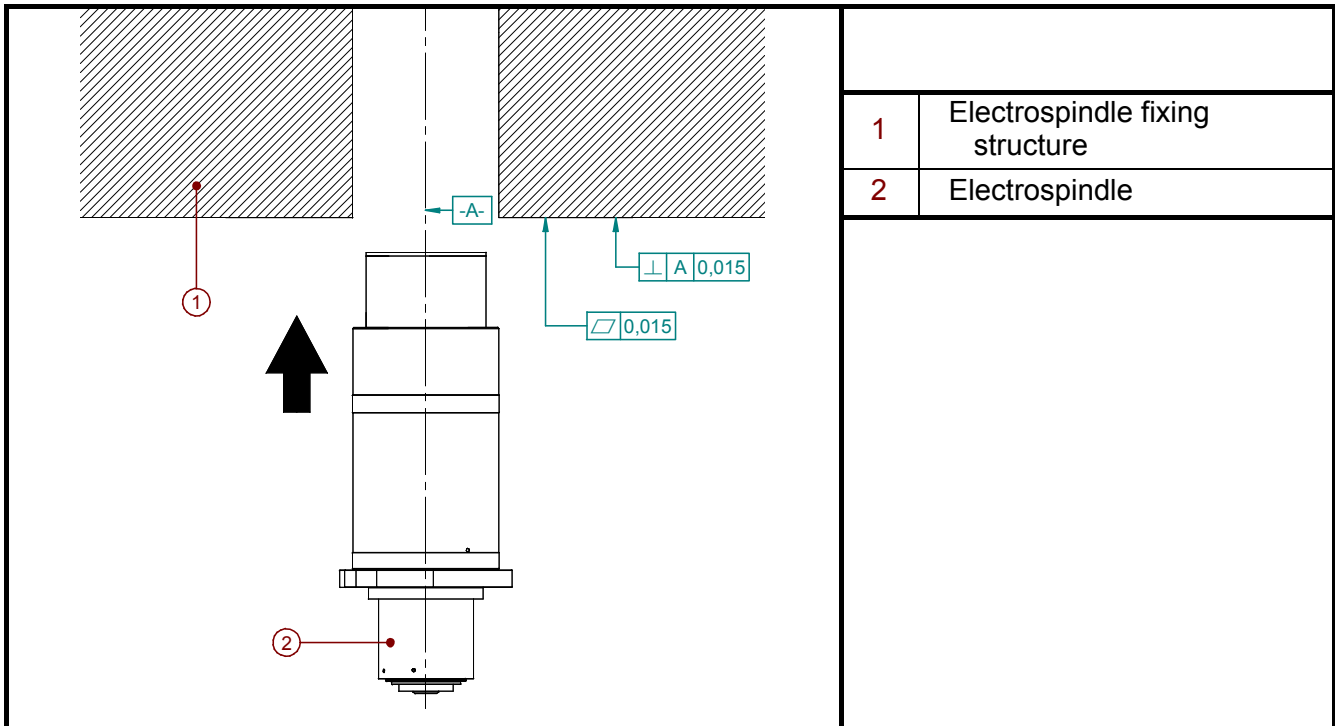

4.3.4 Tool change system

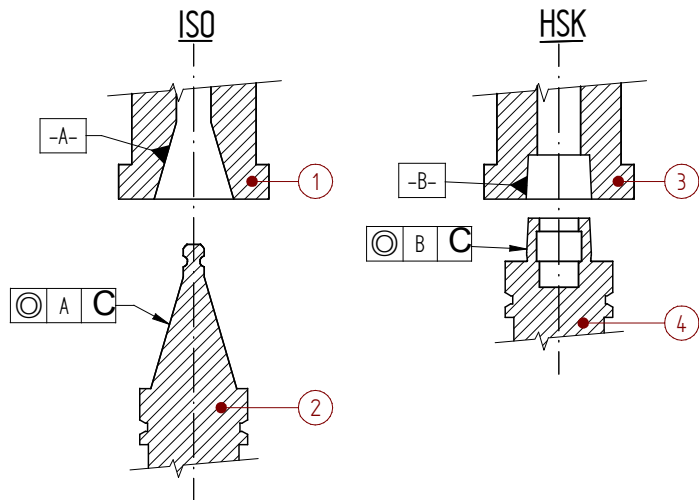

1	Spindle shaft ISO 30
2	Tool-holder cone ISO 30
3	Spindle shaft HSK F63
4	Tool-holder cone HSK F63



The tool-holder magazine must position the cones with a concentricity error between the spindle shaft and the tool-holder cone as shown in the table below.

Tool hooking system	Concentricity "C" (mm)
ISO 30	0.2
HSK E50-F63	0.8
HSK E40-F50	0.7
HSK E63-F80	0.8

4.3.5 Fixing electrospindles with rectangular framework

The electrospindle should be fixed to the slide or the spindle holder support (if present), using M8 screws and T-slot nuts with a tightening torque of 20Nm. The maximum protrusion allowed for the fixing screw is 15mm, as shown in *Figure4 .3*; greater protrusions can deform the framework of the electrospindle and produce incorrect blocking, with negative consequences for the precision of the machining operation and the safety.

For the correct alignment, use the tang slot between the two T-slots (see section 2).

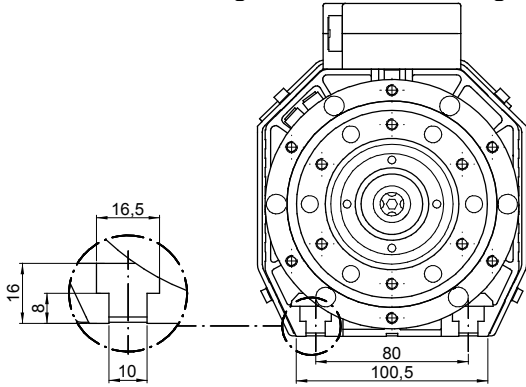

Figure4 .2 T-slots for anchoring the electrospindle

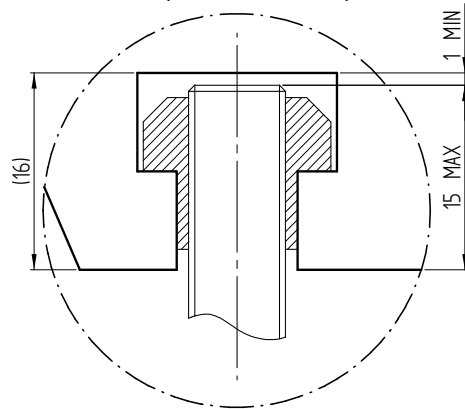

Figure4 .3 Maximum protrusion of the screw in the T-slot



- Maximum protrusion of the screw: 15mm.
- Ensure a gap of at least 1mm.
- Greater protrusions deform the framework of the electrospindle, compromising the precision of the machining operation and also the safety.

4.3.6 Fixing electrospindles with round framework

To fix the electrospindles with a round framework, use the eight $\varnothing 8.5$ bores on the fixing flange

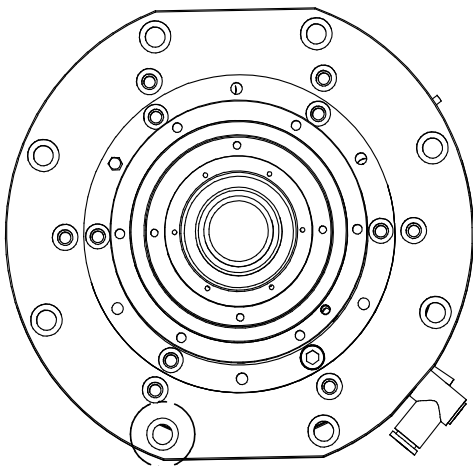

Figure 4.4 8 bores $\varnothing 8.5$

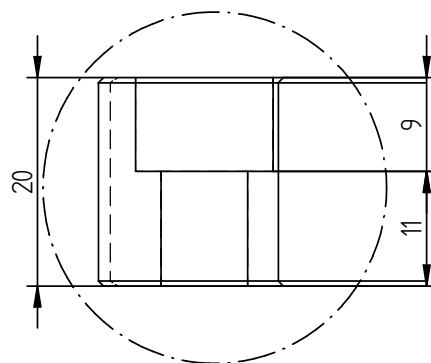

Figure4 .5 Detail of fixing bore

4.3.7 Threaded bores for accessories

To fix any accessories, some threaded bores are available (see the positions in section 2). The useful thread is 12mm.

4.4 PNEUMATIC CONNECTIONS

4.4.1 Air purity



IMPORTANT:

Introduce in the electrospindle compressed air of a purity in accordance with ISO 8573-1, classes 2, 4, 3, i.e:

- class 2 for the solid particles:
solid particle size < 1 µm;
- class 4 for the humidity:
dew-point < 3°C (37.4°F)
- class 3 for the total oil:
concentration of oil < 1 mg / m³

Failure to comply with these specifications may result in product malfunction.
The guarantee is not valid if pollutants are found during repair operations.



As an example, the above-mentioned specifications can be implemented by following the indications below:

- If a lubricated air circuit is present in the machine, it should be isolated from the dry air circuit (to be used by the electrospindle) by means of non-return valves.
- The filters indicated in this section should be installed as near the electrospindle as possible.
- taking into account the fact that the efficiency of the filters is <100%, it is essential that the machine be fed with properly treated air;
As a general guide, introduce (into the circuit indicated in this section) compressed air with a purity rating complying with ISO 8573-1, classes 7, 6, 4, i.e.:
 - Type 7 for solid particles:
solid particle size < 40 µm;
solid particle concentration < 10mg/m³;
 - class 6 for the humidity:
dew point < 10°C;
 - class 4 for the total oil:
oil concentration < 5 mg/m³;
- at the end of the working day, empty the pneumatic system to enable the automatic purging of filters;
- Carry out regular maintenance operations of the filters according to the manufacturer's indications, and replace them when they are saturated and lose effectiveness (approximately every 6/12 months).

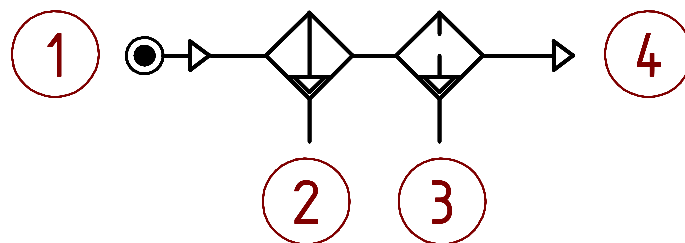

1	Mains power supply.
2	Pre-filter 5 µm.
3	De-oiling filter 0.1 µm.
4	To the HSD product.

4.4.2 Pneumatic connection points for spindles with single-acting cylinder

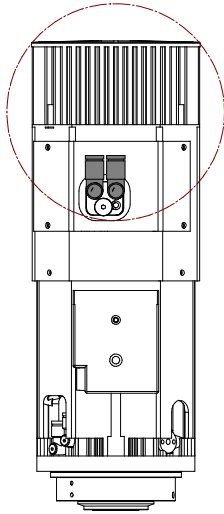

<i>Ref.</i>	<i>Description</i>	<i>Pressure</i>	<i>Ø Tube</i>
1	Tool-holder release	6 bar	Ø 8 x 6
2	Pressurisation and cone cleaning	4 bar	Ø 8 x 6

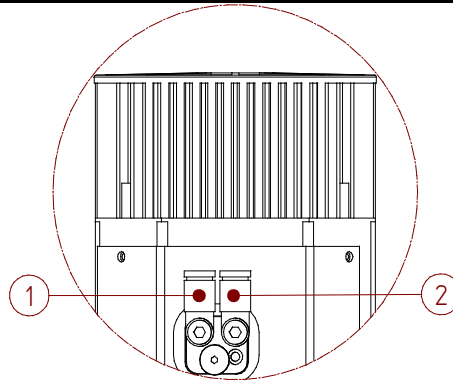

4.4.3 Variation with vertical block (single-acting cylinder)

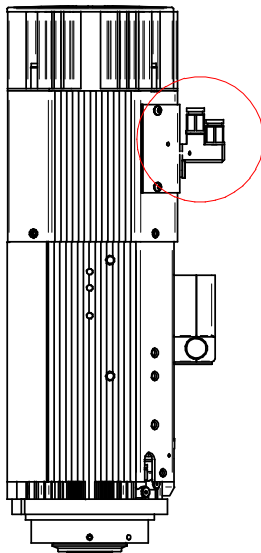

<i>Ref.</i>	<i>Description</i>	<i>Pressure</i>	<i>Ø Tube</i>
1	Tool-holder release	6-7 bar	Ø 8 x 6
2	Pressurisation and cone cleaning	6-7 bar	Ø 8 x 6

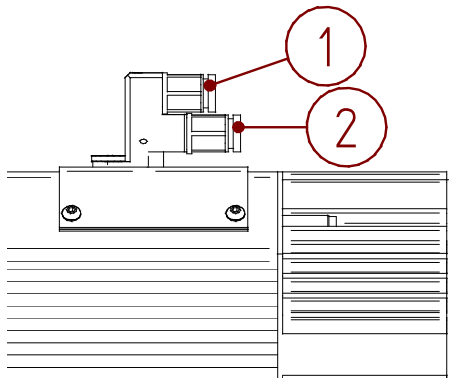

Example layout for the pneumatic circuit arranged by the customer

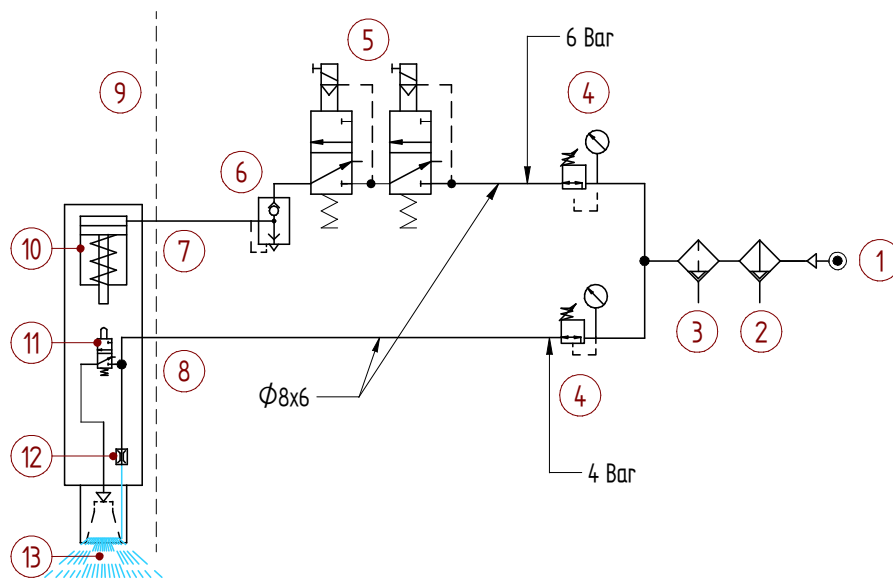

1	Mains power supply.
2	Pre-filter 5 μm .
3	De-oiling filter 0.1 μm .
4	Pressure regulator.
5	Pair of 3-way monostable electric valves, normally closed.
6	Quick bleeder valve.
7	Air input for tool-holder release.
8	Air input for cone cleaning and pressurisation.
9	Pneumatic circuit inside the electrospindle.
10	Single acting pneumatic cylinder.
11	Valve to activate the cone cleaning (piston-commanded).
12	Throat.
13	Continuous flow of pressurisation air.



Use two separate circuits to connect the electric valves to the numerical control.



The use of two electric valves in series instead of just one reduces the possibility of malfunctioning. Although such malfunctioning is very rare, the seriousness sometimes means the application of the redundancy principle.

4.4.4 Pneumatic connection points ES939 or variations with “T-block” (double-acting cylinder)

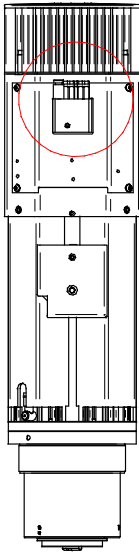

<i>Ref.</i>	<i>Description</i>	<i>Pressure</i>	<i>Ø Tube</i>
1	Tool-holder hook-up	6 bar	Ø 8 x 6
2	Pressurisation	4 bar	Ø 4x2
3	Tool-holder release	6 bar	Ø 8 x 6
4	Cone cleaning (all versions) Air inside tool (optional)	MAX 4 bar	Ø 8 x 6

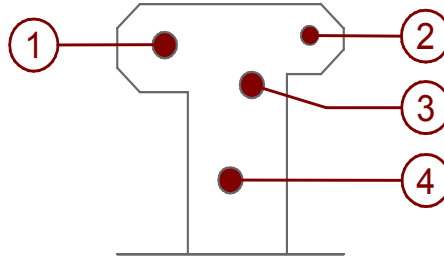

The cylinders of these electrospindles are double-acting: it is necessary to keep the cylinder under pressure to maintain the piston at the upper end stop, far from the fast-rotating parts.

Example layout for the pneumatic circuit (arranged by the customer)

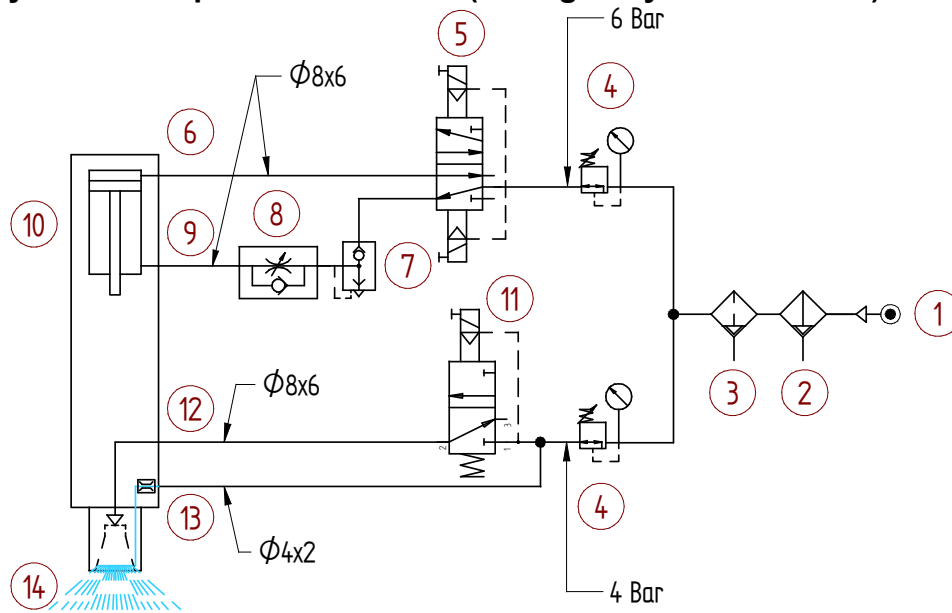

1.	Mains power supply.
2.	Pre-filter 5 μm .
3.	De-oiling filter 0.1 μm .
4.	Pressure regulator.
5.	Monostable valve 5-2, with electro-pneumatic command and spring return
6.	Air inlet for tool-holder release.
7.	Quick bleeder valve.
8.	One-way flow regulator, to adjust ejection speed.
9.	Air inlet for tool-holder hook-up.
10.	Double-acting pneumatic cylinder of the electrospindle.
11.	Monostable valve 3-1, with electro-pneumatic command and spring return
12.	Air inlet for cone cleaning (in all versions) and for air jet via the tool (<i>optional</i>).
13.	Air inlet for pressurisation
14.	Continuous flow of pressurisation air.

4.4.5 Pneumatic connection points for spindles ES884 - ES888 (single-acting cylinder)

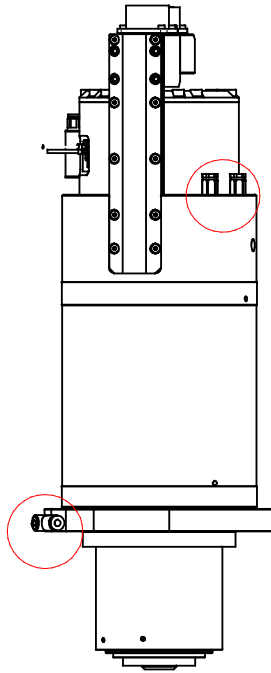

<i>Ref.</i>	<i>Description</i>	<i>Pressure</i>	<i>Ø Tube</i>
1	Tool-holder release	10 bar	Ø 6x4
2	Cone cleaning	4 bar	Ø 6x4
3	Pressurisation	4 bar	Ø 4x2
4	Cooling liquid inlet / output		Ø 8 x 6

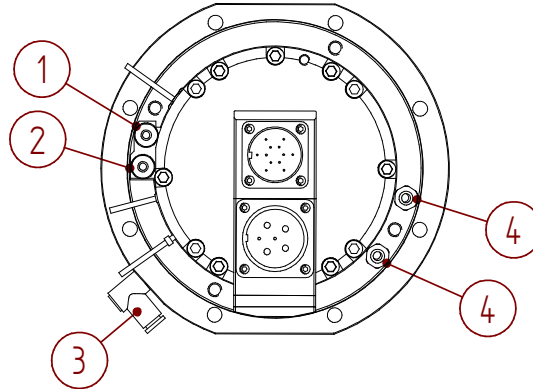

Example layout for the pneumatic circuit arranged by the customer

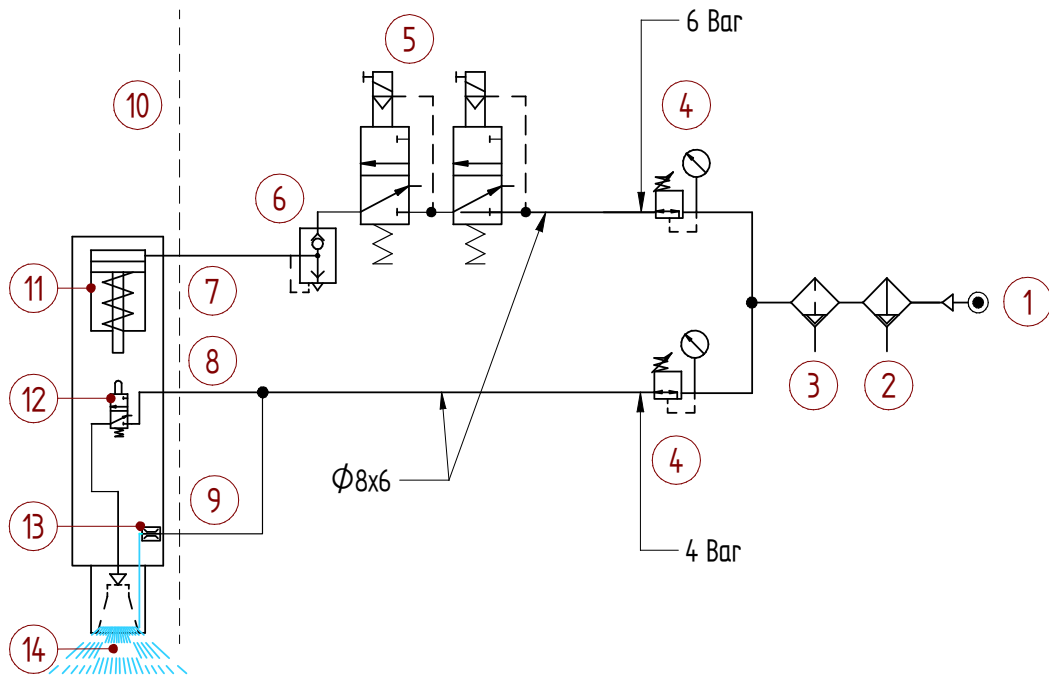

1	Mains power supply.
2	Pre-filter 5 µm.
3	De-oiling filter 0.1 µm.
4	Pressure regulator.
5	Pair of 3-way monostable electric valves, normally closed.
6	Quick bleeder valve.
7	Air input for tool-holder release.
8	Air inlet for cone cleaning
9	Air inlet for pressurisation
10	Pneumatic circuit inside the electrospindle.
11	Single acting pneumatic cylinder.
12	Valve to activate the cone cleaning (piston-commanded).
13	Throat.
14	Continuous flow of pressurisation air.



Use two separate circuits to connect the electric valves to the numerical control.



The use of two electric valves in series instead of just one reduces the possibility of malfunctioning. Although such malfunctioning is very rare, the seriousness sometimes means the application of the redundancy principle.

4.4.6 Internal volumes of the pneumatic cylinders

Electrospindle model	Volume of the pneumatic cylinder
ES919, 929, 915 ISO	0.14 litres (8.5 cu in)
ES919, 929, 915, HSK	0.19 litres (11.6 cu in)
ES884 HSK E63	0.12 litres (7,3 cu in)
ES888 HSK F63	0.23 litres (14 cu in)
ES988 ISO30 / HSK F63	0.23 litres (14 cu in)

4.4.7 Internal pressurisation

The pneumatic circuit of internal pressurisation prevents harmful particles from entering the electrospindle. The air introduced finds an outlet through the gaps of the front labyrinth, in the area of the electrospindle nose.



Pressurisation air must always be present, even when the electrospindle is stopped and the machine switched on. It must also be present during machine maintenance and cleaning operations, to prevent dust from getting inside.

With the spindle at standstill, check there is a uniform outlet of air around the spindle shaft (pressurisation); if this is not the case, check the efficiency of the pneumatic circuit and the tightness of the connections.

MODEL	CONSUMPTION		EQUIVALENT VOLUME (1 Atm - 20°C - 68°F)
ES915	12 l/min - 0.42 cfm	(4 bar - 20°C - 68°F)	48 l/min - 1.7 cfm
ES919	12 l/min - 0.42 cfm	(4 bar - 20°C - 68°F)	48 l/min - 1.7 cfm
ES988	12 l/min - 0.42 cfm	(4 bar - 20°C - 68°F)	48 l/min - 1.7 cfm
ES939	14 l/min - 0.49 cfm	(4 bar - 20°C - 68°F)	56 l/min - 2.0 cfm
ES884	11,5 l/min - 0.40 cfm	(4 bar - 20°C - 68°F)	46 l/min - 1.6 cfm
ES888	11,5 l/min - 0.40 cfm	(4 bar - 20°C - 68°F)	46 l/min - 1.6 cfm

4.4.8 Cleaning the tool-holder cone

The air jet for cleaning the cone is automatically activated during the tool change phase in those spindles fitted with a single-acting piston.

For spindles with a double-acting piston, the operation is not automatic:

the customer must arrange for a solenoid valve that will open during the tool change phase, when the output of sensor S2 is "ON" (see ref. 11 on page 75)

This procedure protects the coupling surfaces against deposits of contaminants.

The condition of the connecting surfaces and their degree of cleanliness must be checked at regular intervals as described in section 7.



The jet of cleaning air must be active for the whole time that the collet is open.

4.5 HYDRAULIC CONNECTIONS AND SPECIFICATIONS OF THE COOLER

For the hydraulic connection points see the dimensional drawings and the labels on the product. Use water charged with 10% ethylene glycol and with anti-corrosion additives.



The gaskets that isolate the fluid circuits inside HSD products are made of nitrile rubber: use only additives that do not degrade this material.

Upon request, HSD supplies "ARTIC-FLU-5" (order No.: H2161H0022).

ARTIC-FLU-5 is a pre-mixed cooling liquid, ready for use and tested by HSD S.p.A.

It contains monoethylene glycol and corrosion inhibitors (based on an ecological formula and without amines, nitrates or phosphates) and ensures protection against corrosion for roughly 1 year.

ARTIC-FLU-5 prevents the formation of rust, scale and foam deposits, as well as the hardening, cracking or swelling of the seals and sleeves.

It complies with various international standards, including CUNA NC 956-16.

4.5.1 Specifications for the cooler

	<i>Spindles from 0 to 12 kW</i>	<i>Spindles from 13 to 20 kW</i>
Cooling capacity	1,600 W	3,400 W
Minimum flow rate	3 litres/minute	3 litres/minute
Type of coolant	Water + 10% ethylene glycol + corrosion inhibitor	Water + 10% ethylene glycol + corrosion inhibitor
Set temperature of the cooler	+25+/-3°C (+77+/-5°F)	+25+/-3°C (+77+/-5°F)

4.6 ELECTRICAL CONNECTIONS

4.6.1 Connectors

In the electrospindle there are two electrical connectors for power and signals respectively; the two connectors are located in an electrical box also known as the “fixed mounting plate”. A “mobile mounting plate” is also supplied with the electrospindle, with the mobile connectors to be wired by the customer. Upon request, pre-wired “mobile mounting plates” are available, with cables of different lengths.

The position of the electrical connectors is shown in section 2.

4.6.1.1 Layout of POWER connector (fixed part)

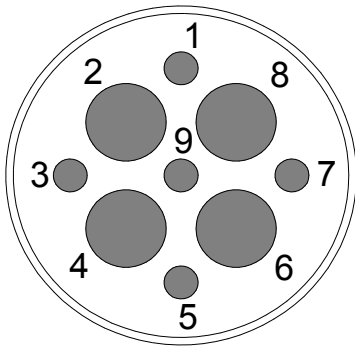

PIN	DESCRIPTION
1	Thermal alarm
2	Common PE with PIN 7
3	230V AC 50/60Hz electric fan (if present)
4	U Motor phase
5	Thermal alarm
6	Motor V phase
7	Common PE with PIN 2
8	Motor W phase
9	230V AC 50/60Hz electric fan (if present)



Use cables of not less than 6mm² (or AWG10) for the even PINs, and 1mm² (or AWG18) for the odd ones



The electrical power supply to the electrospindle **MUST** be provided via inverter.

4.6.1.2 Layout of SIGNALS connector (fixed part) - ISO VERSION

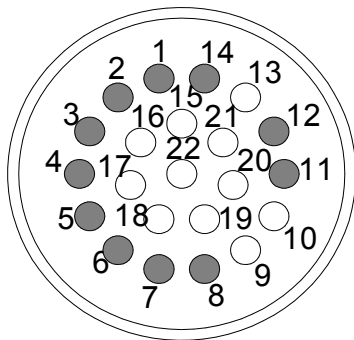

PIN	DESCRIPTION
1	OUTPUT sensor S2 (collet open).
2	OUTPUT sensor S1 (presence of tool-holder)
3	OUTPUT sensor S3 (shaft stopped) <i>(optional)</i>
4	+24V CC power supply S1, S2, S3.
5	+24V CC power supply bulb on the button.
6	0V power supply S1, S2, S3.
7	+24V CC power supply to button and SC sensor (C-axis zero setting)
8	Button OUTPUT
9	Not used
10	Not used
11	0V power supply BUTTON, BULB and SC sensor
12	SC sensor OUTPUT (zero setting C-axis)
13	Not used
14	For HSD maintenance.
From 15 to 22: Not used.	



Use 0.35mm² cables or AWG22

4.6.1.3 Layout of SIGNALS connector (fixed part) - HSK VERSION

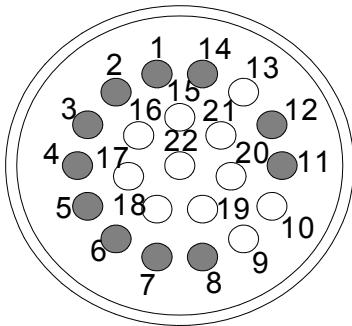

PIN	DESCRIPTION
1	OUTPUT sensor S2 (collet open).
2	OUTPUT sensor series S1+S4 (tool holder correctly blocked).
3	OUTPUT sensor S3 (shaft stopped) <i>(optional)</i>
4	+24V CC power supply S1, S2, S3.
5	+24V CC power supply bulb on the button.
6	0V power supply S1, S2, S3.
7	+24V CC power supply to button and SC sensor (C-axis zero setting)
8	Button OUTPUT
9	Not used
10	Not used
11	0V power supply BUTTON, BULB and SC sensor
12	SC sensor OUTPUT (zero setting C-axis)
13	Not used
14	For HSD maintenance.
From 15 to 22: not used	



Use 0.35mm² cables or AWG22

4.6.2 Military connectors

In some HSD electrospindle models a “boosted” fixed mounting plate is available. On it there are the “military” connectors, whose dimensions are greater than those of the standard connectors.

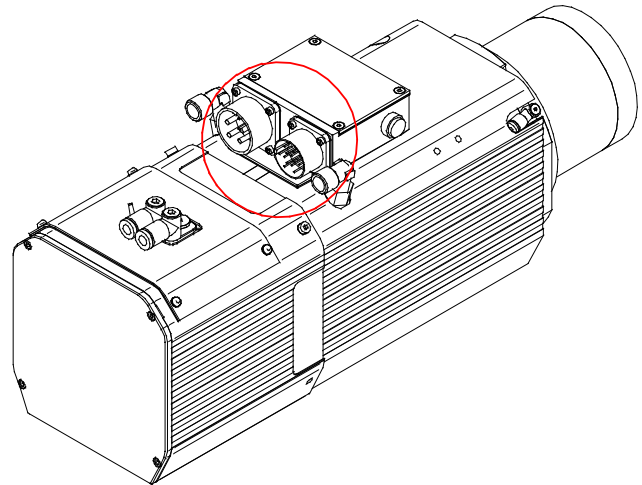

4.6.2.1 Power connector

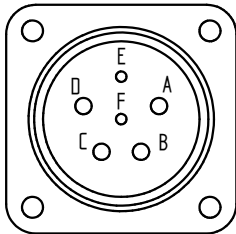

A	U motor phase
B	V motor phase
C	W motor phase
D	Earth connection
E	230V AC 50/60Hz electric fan (if present)
F	230V AC 50/60Hz electric fan (if present)

4.6.2.2 Sensors connector

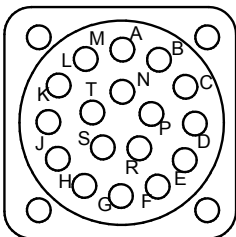

A	S2 sensor (tool ejected) OUTPUT
B	S1+ S4 sensor series (tool locked) OUTPUT
C	OUTPUT sensor S3 (shaft stopped)
D	+24V CC power supply sensors S1, S2, S3.
E	+24V CC power supply to lamp of button
F	0V power supply sensors S1, S2, S3, S4.
G	+24V CC power supply to button and sensor SC
H	OUTPUT button
J	0V power supply to lamp of button and sensor SC
L	SC sensor OUTPUT (C-axis zero-setting)
M	For maintenance
N	Motor thermal alarm
P	Motor thermal alarm

4.6.2.3 Encoder connector (optional)

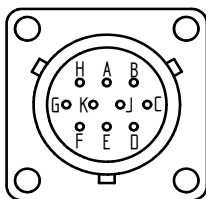

A	A +
B	A -
C	B -
D	GND
E	Z +
F	5 V DC
J	B +
K	Z -

4.6.3 Configurable power supply terminal board 220/380 V (optional)

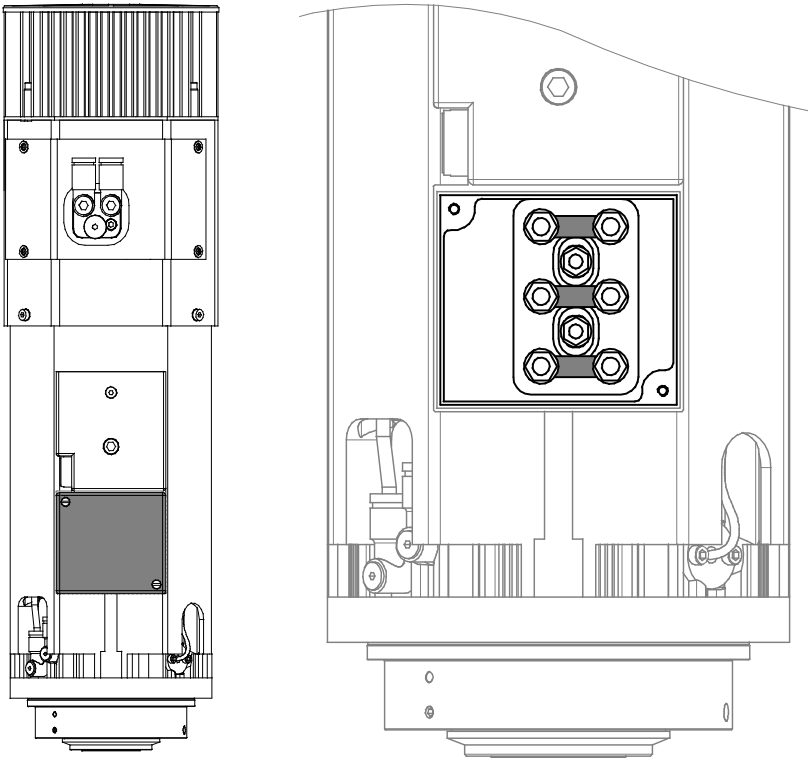

Upon request, some models are available with delta or star configurable power supply terminal boards, to be used with a rated voltage of 380V or 220V.

The models available in the configurable version are highlighted in chapter 3.

The position of the terminal board is shown alongside, protected by a cover fixed with two screws.

 **Before installing, check the type of connection in the terminal board**

CONNECTIONS LAYOUT

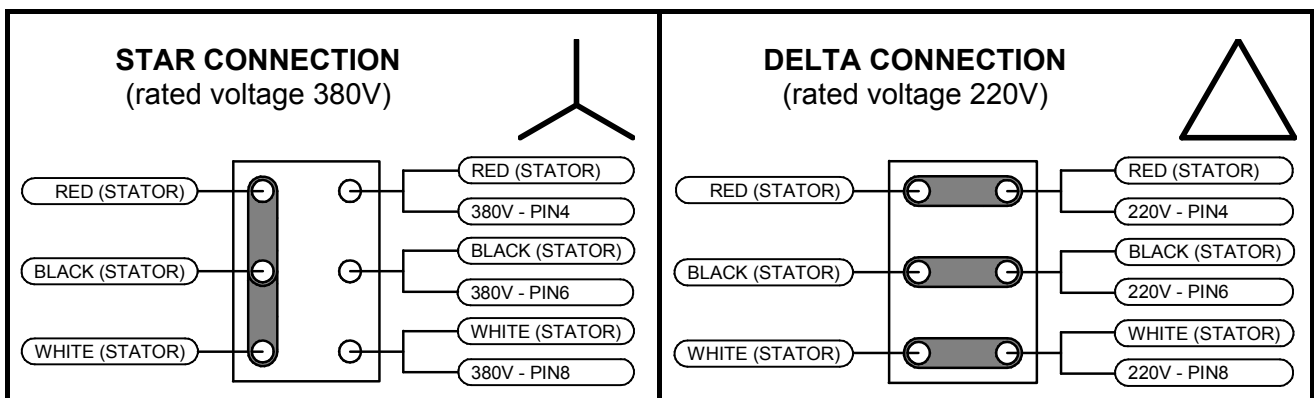

 **IMPORTANT:** In the star connection (for a rated voltage of 380V), the clamps to be joined in short-circuiting are those connected to a single cable.

4.6.4 ES988 with configurable terminal board 220/440 V (optional)



Before opening the mounting plate to perform any operation, check that all the electrically powered parts are disconnected.

SET VOLTAGE 220 V

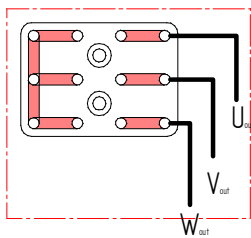

SET VOLTAGE 440V

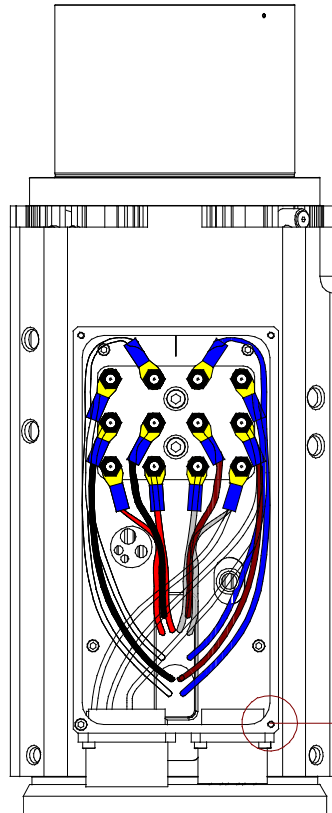
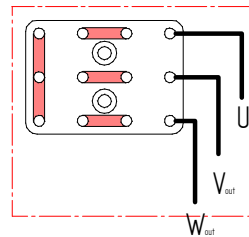

Serrare le viti del coperchio della basetta a 1.3 Nm

4.6.4.1 Power connector

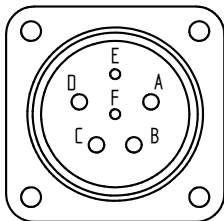

A	U motor phase
B	V motor phase
C	W motor phase
D	Earth connection

E 230V AC 50/60Hz electric fan

F 230V AC 50/60Hz electric fan

4.6.4.2 Sensors connector

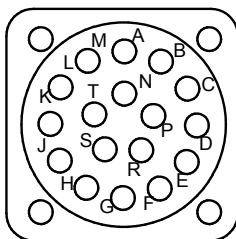

A	S2 sensor (tool ejected) OUTPUT
B	S1+ S4 sensor series (tool locked) OUTPUT
C	OUTPUT sensor S3 (shaft stopped)
D	+24V CC power supply sensors S1, S2, S3.
E	+24V CC power supply to lamp of button
F	0V power supply sensors S1, S2, S3, S4.
G	+24V CC power supply to button
H	OUTPUT button
J	0V power supply to lamp of button
L	Not used
M	For maintenance
N	Motor thermal alarm
P	Motor thermal alarm

4.7 BUTTON FOR MANUAL COMMAND OF TOOL RELEASE

On some models there is a button to manually command the release of the tool-holder: by keeping the button pressed the tool is expelled and the collet remains open until the button is released.

i The position of the button is shown in section 2

CHARACTERISTICS OF THE BUTTON	
Rated voltage (DC)	24V
Maximum current	100 mA

CHARACTERISTICS OF THE LAMP	
Rated voltage (DC)	24V
Rated power	0.7W
Rated current	29 mA

4.7.1 Electrical layout for tool-holder manual release circuit



- When the spindle is rotating, a control system must deactivate the command arriving from the button.
- The activation of the button must only be possible with the spindle idle.
- The tool block/release operation via the button must only be carried out with the machine in MANUAL working mode (not AUTOMATIC).
- The tool could be ejected at high speed if the safety conditions described above are not respected.

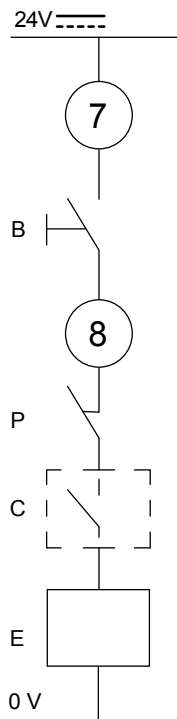

7 - 8	PINs 7 and 8 of the SIGNALS connector
B	Button for manual release of tool
P	Pressure switch that, in the event of low pressure, does not allow the release of the tool holder
C	Safety check (device at null speed)
E	CNC

5 GENERAL CHECKS AFTER INSTALLATION

5.1 CHECKS BEFORE THE START-UP

5.1.1 Positioning

- Check the conformity with the specifications of section 4.3.1

5.1.2 Pneumatic connections

- Refer to section 4.4 and check the correctness of the pneumatic connections, the pressure levels used and the purity of the compressed air.
- The pressurisation air must always be present, even when the electrospindle is stopped. With the spindle at standstill and the tool holder inserted, check there is a uniform, continuous outlet of air from the area of the spindle nose around the shaft.
- The air jet for cleaning the cone must be present during the tool change phase.

5.1.3 Electrical connections



The earthing of the electrospindle (see section 4.6.1.1) must be connected to the earthing of the machine.



The thermal alarm must activate a procedure for protecting against the overheating of the electrospindle coils (see section 6.9.4).

5.1.4 Programming the inverter

- The maximum voltage set on the inverter must correspond to the rated value indicated on the motor rating plate;
- The frequency value at which the maximum voltage (rated frequency) is to be attained must correspond to the value indicated on the motor rating plate;
- The maximum speed set on the inverter must correspond to the value indicated on the motor rating plate;
- The maximum direct current supplied to the inverter must correspond to the rated current indicated on the motor rating plate;
- If it is considered necessary to check the other parameters of the inverter, please contact HSD S.p.A.

5.2 START-UP CHECKS



Only run the electrospindle if the signal on pin no.2 of the signals connector is "ON".



The "ON" condition corresponds to an output equal to the supply voltage of the sensors; the "OFF" condition corresponds to an output of 0V.



Only for HSK versions:
it is forbidden to run the electrospindle without the tool-holder inserted.

- the control sensors must intervene according to the logic described in section 6.9.2;
- the tool changing cycle may only start when the shaft is at a standstill;
- check the correct working of the cooling system;
- without making any machining operations, carry out the preheating cycle described in section 6.3.

6 USE AND ADJUSTMENT

6.1 ENVIRONMENTAL CONDITIONS

HSD S.p.A. has inspected and checked its products in accordance with standard environmental conditions (CEI EN 60034-1:2006-05)

Contact HSD S.p.A. for information on the possibility of applications in special environments.

6.2 RUNNING-IN

Before being packed, the product was subjected to an automatic running-in cycle to guarantee the correct distribution of the lubricant (long-life grease) on the races of the bearings, and to run in the spheres and races of the bearings themselves. If present, also the reducers and servomotors are run in, and dynamic tests are carried out on the inner pneumatic and hydraulic circuits.

The running-in cycle also includes a strict inspection of all the command and signalling elements, simulating various types of operating cycle on the test bench.

6.3 PREHEATING

HSD S.p.A. uses high-precision angular contact bearing pairs, pre-loaded and lubricated for life with special grease for high speeds.

When the machine is switched on for the first time every day, allow the electrospindle to perform a brief preheating cycle in order to allow the bearings to gradually attain a uniform operating temperature, and hence to obtain a uniform expansion of the bearing races and the correct preload and rigidity.



The following cycle is recommended, without machining operations:

- 50 % of the maximum rated speed for 2 minutes.
- 75 % of the maximum rated speed for 2 minutes.
- 100 % of the maximum rated speed for 1 minute.

The preheating cycle should also be performed every time that the machine is inoperative long enough for the electrospindle to cool down to room temperature.



Only for HSK versions:
it is forbidden to run the electrospindle without the tool-holder inserted.



While the machine is operating, the spindle can reach high temperatures. Be very careful not to touch it without due precautions.

6.4 ELECTRIC FAN

In the air-cooled versions, the electrospindle is cooled by an electric fan installed at the rear. Its rotation is independent of the rotation speed of the spindle shaft: in this way, the cooling efficiency is better compared with a situation where the fan is integral with the spindle shaft.



The electric fan must always be activated, even when the electrospindle is idle.

6.4.1 Technical characteristics of the electric fan

Power supply	230 ± 10% V AC	
Frequency	50 Hz	60 Hz
Input power	45 W	39 W

6.5 TOOL-HOLDER LOCKING AND EXPULSION DEVICE

The blocking and expulsion of the tool-holder is carried out by the single-acting movement of a pneumatic piston, activated with compressed air.

The tool-holder is mechanically blocked with elastic springs.

electrospindle model	axial force on the tool-holder	expulsion of the tool-holder cone
ISO30	3200 N ± 10%	0.5 - 0.9mm
HSK F63/E50	11000 N ± 10%	0.5 - 0.6mm
HSK E40/F50	6800 N ± 10%	0.5 - 0.6mm
HSK E63/F80	18000 N ± 10%	0.5 - 0.6mm



The axial force exerted on the tool-holder by the blocking system is guaranteed constant for a minimum duration of 2,000,000 cycles of tool change

1 tool change cycle = tool blocked / tool released / tool blocked



All HSD electrospindles have a mechanical reaction system that neutralises the axial force of the piston on the shaft during the tool changing phase, guaranteeing the integrity of the precision bearings.

6.6 TOOL-HOLDER CONE

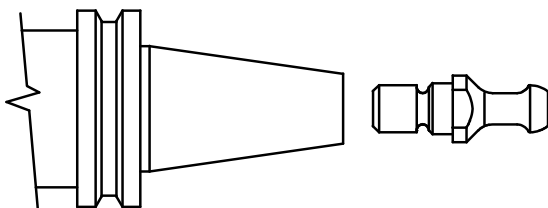

Figure 6.1 CONE ISO30 DIN69871 HSD TIE-ROD 0804H0009

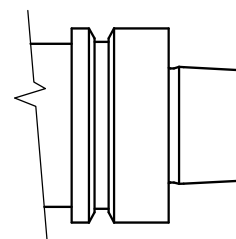

Figure 6.2 HSK DIN69893 CONE

- The geometry of the conicity must respect standard DIN69871 for ISO30 cones, and standard DIN69893 for HSK cones.
- The tool-holder cone ISO30 must have an AT3 precision rating;
- Avoid the presence of plugs, slots, or other forms affecting the dynamic balancing of the tool-holder;
- At the maximum rated speed of the electrospindle, the level of dynamic balancing must be G = 2.5 or better (ISO1940 standard);
- The balancing must be carried out with the tool-holder assembled (cone, mill collet, ring nut, tool);
- The tie-rod (also known as the shank) of the cone ISO30 must only be the one supplied by HSD (code 0804H0009).

6.6.1 Installation of the tie-rod HSD 0804H0009 in the cone ISO30 DIN69871

- Carefully clean the tie-rod and the tie-rod housing in the cone ISO30.
- Cover the thread of the tie-rod with high resistance, thread-blocking liquid (LOCTITE 270 or another equivalent product).
- Tighten the tie-rod to the cone with a torque of 62 Nm.
- Leave the cone to rest, to allow the thread-blocking liquid to adhere (12 hours with LOCTITE 270, or depending on the manufacturer's indications if using an alternative, equivalent thread-blocker).



The use of non-original HSD tie-rods, or incorrect installation, may cause the tool-holder cone to fly off.



It is forbidden to use ISO or HSK tool-holders not conforming to the conditions described above; failure to observe these instructions represents a source of risk of breakage or incorrect hook-up of the tool-holder cone, with serious risks for the user.

6.6.2 General recommendations for the tool-holder cones



IMPORTANT:

- The choice of tool-holder is a determining factor for safety purposes.
- The conical surfaces of the tool-holder and its housing on the spindle shaft must be kept thoroughly clean in order to permit secure hooking-up (see section 7 "Scheduled maintenance").
- During machining operations, be sure to avoid any contact between the non-cutting rotating parts and the piece being machined.
- The seat of the tool-holder cone must always be protected against any impurity that may come in: use a closing device or a tool-holder cone.
- At the end of the working day, always remove the tool-holder cone from the electrospindle, to avoid any problem of it sticking. Replace it with a clean tool-holder cone at room temperature, to protect the inside of the electrospindle from the outer environment.
- Only for HSK versions: do not set the electrospindle in rotation without the tool-holder installed. This would compromise the balancing and working of the collet.

6.7 TOOL

The tools must have a degree of dynamic balancing of $G = 2.5$ or better (standard ISO1940) at the maximum rated speed of the electrospindle.

When selecting the tool, it is essential to pay attention to the following recommendations:

- Always use properly sharpened tools, locking them correctly in the respective tool-holder.
- Never use deformed or damaged tools, tools with missing parts or tools that are not perfectly balanced.
- Before inserting the tool in the respective collet, always check that all the surfaces are free from damage and thoroughly cleaned.
- The essential requirements for using a tool at high speed are:
 - a compact, short, lightweight tool
 - precise, and with any inserts blocked with a high degree of safety
 - balanced and coupled symmetrically with the tool-holder
 - with bits near the rotation axis

6.7.1 Speed limits



OBSERVE THE MAXIMUM ROTATIONAL SPEED (rpm) SPECIFIED BY THE TOOL MANUFACTURER.

Under no circumstances must the maximum speed indicated by the tool manufacturer be exceeded.

Depending on the machining operation to be performed, it is the responsibility of the user to decide whether to operate with a lower speed (NEVER HIGHER) than that specified by the tool manufacturer or shown on the following pages.

6.7.2 Maximum speed and shape of the tool

As an example, the charts on the following pages show the maximum rotation speed of the electrospindle when empty, on the basis of the weight of the TOOL+TOOL HOLDER assembly (including ring nut and mill collet if present), and of the distance between the nose of the electrospindle and the centre of gravity "G" of the tool+tool holder assembly.

Next to each chart there is the tool+tool holder assembly that was envisaged as assembled in the spindle shaft to calculate the curves.

The mass of the tool+tool holder assembly was applied to the centre of gravity "G", highlighted in the design.

Some possible positions of the centre of gravity "G" were considered, and for each position a curve has been drawn on the chart.

The degree of balancing is that recommended in the previous paragraphs.



If the position of the centre of gravity "G" is not known, section 6.7.2.1 gives a simplified procedure to calculate it.

6.7.2.1 Calculating the centre of gravity of the tool+tool holder assembly

If the position of the centre of gravity of the tool+tool holder assembly is not indicated by the manufacturer, it can be roughly calculated in the following way:

1. Consider the tool as made up of elementary parts; in the example of the following figure, the tool consists of two cylindrical parts (one being a slot) and two truncated conical parts.

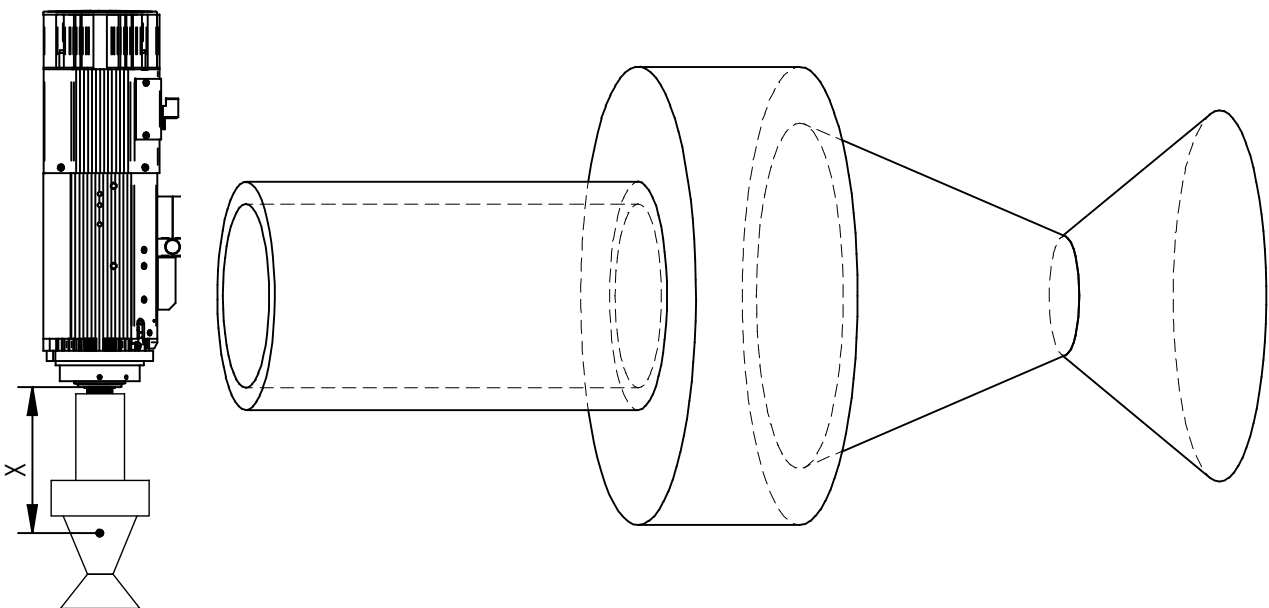

2. For each elementary part, calculate the centre of gravity as indicated below.

i	<p>In the formulas shown below, the following symbols are used:</p> <p>G : centre of gravity X : absolute position of the centre of gravity b : relative position of the centre of gravity; V : volume; m : mass; d : density (in the absence of data supplied by the toolmaker, use the following general densities: Iron: 7850kg/m³; Aluminium: 2100kg/m³).</p>
----------	--

3. Elementary formulas for calculating the centre of gravity:

3.1. Cylindrical segment (possibly cable):

Posizione G : $b = \frac{h}{2}$

Volume : $V = \pi(r_2 - r_1)^2 h$

Massa : $m = Vd$

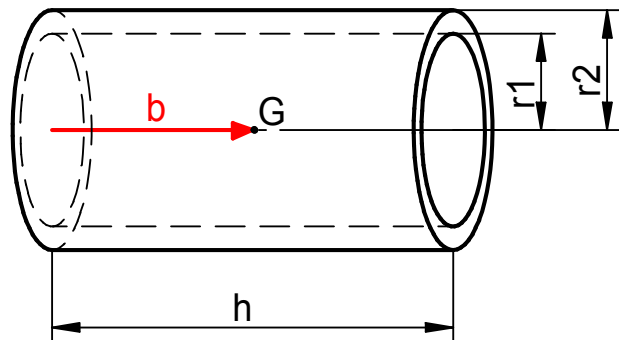

3.2. Conical segment:

Posizione G : $b = \frac{h(r_2^2 + 2r_2r_1 + 3r_1^2)}{4(r_2^2 + r_2r_1 + r_1^2)}$

Volume : $V = \frac{1}{3}\pi(r_2^2 + r_2r_1 + r_1^2)h$

Massa : $m = Vd$

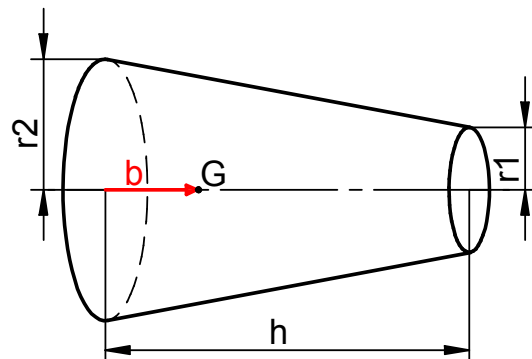

4. Obtain the position of the centre of gravity of the assembly, starting from the centres of gravity of the individual parts:

$$X = \frac{(m_1x_1 + m_2x_2 + m_3x_3 + m_4x_4)}{(m_1 + m_2 + m_3 + m_4)}$$

(in yellow, the reference faces for measuring "b")

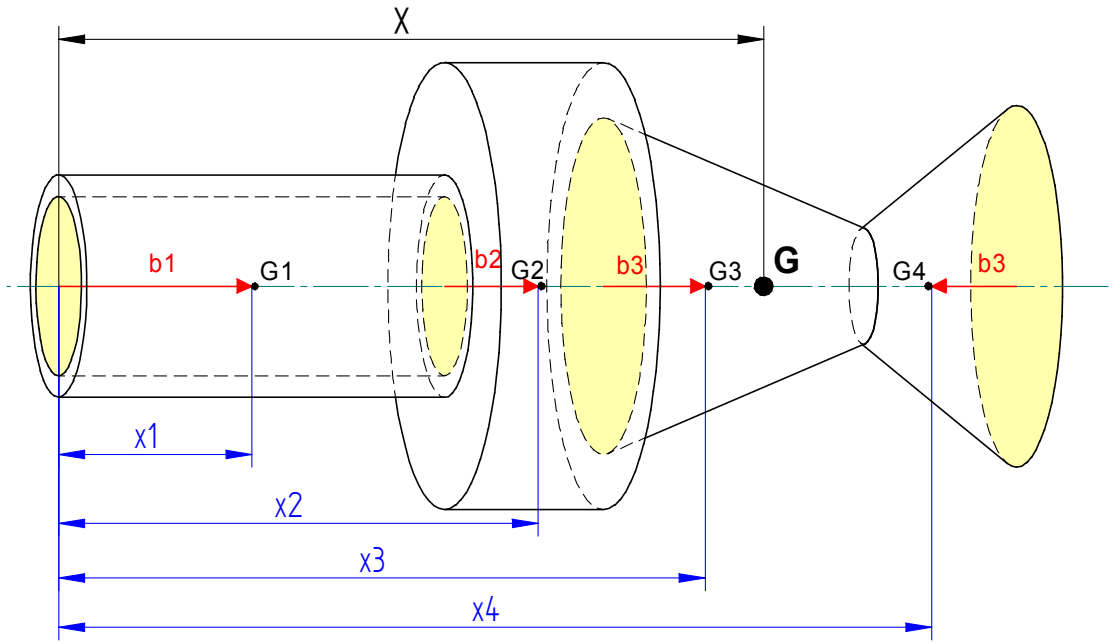

5. Use the value X to choose the right curve of the chart

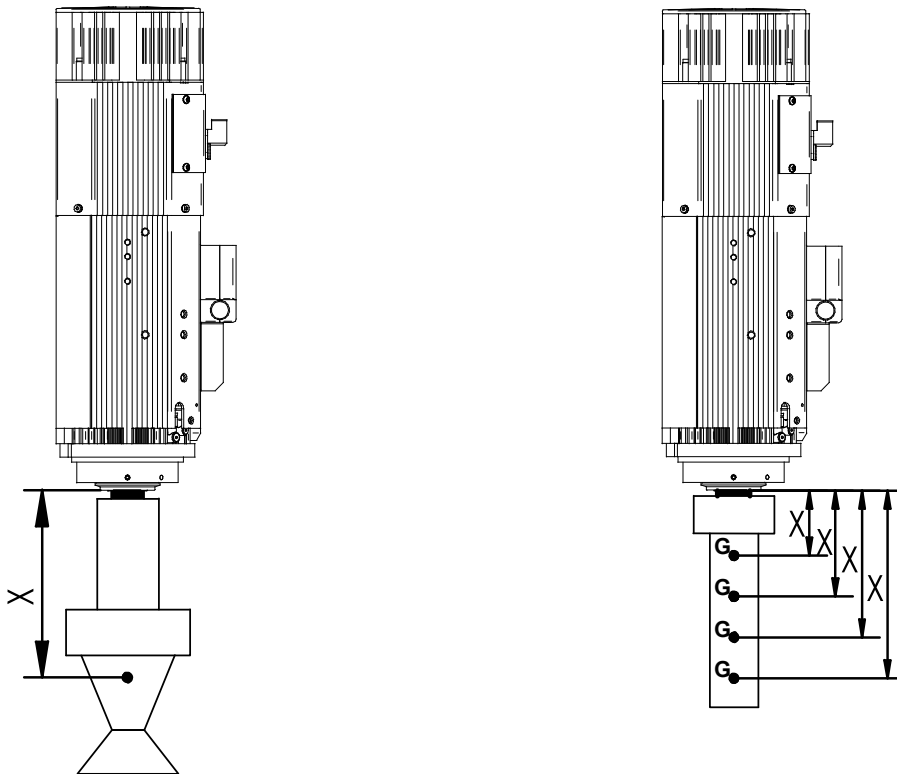

Your tool, of whatever shape, can be considered equivalent to a cylindrically-shaped tool (like the one illustrated next to the charts on the following pages). From the charts, choose the curve corresponding to the position of the centre of gravity of your tool, and read the maximum rpm corresponding to the weight of your tool.

6.7.2.2 Procedure for reading the charts



The charts on the following pages are approximate, in that they do not take into account (because HSD S.p.A. cannot know this information) of the machining operation parameters, the specific characteristics of the tool used by the customer, or the particular type of material being worked:
it is the user's responsibility to evaluate each time the maximum speed that allows him to work safely.

1. Identify the chart relating to your electrospindle.
2. On the basis of the distance "X" between the spindle nose and the centre of gravity "G" of the tool+tool holder assembly, choose one of the curves. If the "X" measured on your electrospindle does not appear on the chart, choose the curve associated with the "X" that is the next measurement bigger (see example).
3. Corresponding to the weight of the tool+tool holder assembly, read the value of the maximum speed.
4. If the weight or the distance of G are greater than those envisaged by HSD, it will be the user's responsibility to evaluate each time the maximum speed that allows him to work safely.



If you are concerned that the tool is too big and could damage the electrospindle, contact HSD Customer Service

EXAMPLE 1

On an ES929 L HSK F63 SHORT NOSE, you want to use a tool+tool holder assembly with an overall weight of 3.5kg (including the ring nut and mill collet); the distance between the spindle nose and the centre of gravity "G" of the tool+tool holder assembly is "X"=120mm:

1. The chart relating to this particular electrospindle is that in paragraph 6.7.2.6
2. With no specific curve for "X"=120mm, it is necessary to refer to the yellow curve associated with "X"=130mm
3. Corresponding to the weight of 3.5kg, you can read the maximum speed, when empty, of 10000 rpm.

EXAMPLE 2

On an ES929 L ISO 30 SHORT NOSE, you want to use a pack of milling cutters comparable with a cylinder of diameter 100mm, length 100mm and overall weight 4.5kg:

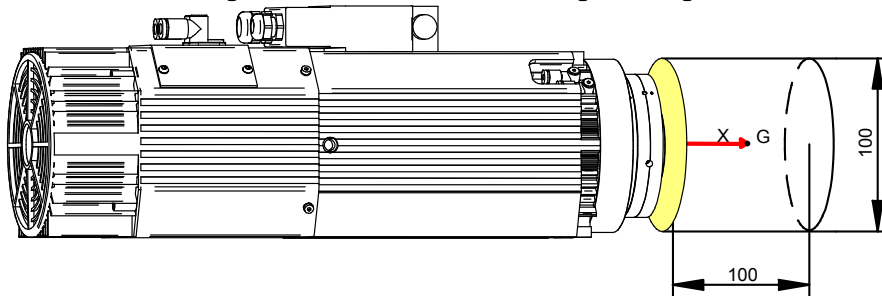

1. $b=h/2=100/2=50\text{mm}$
2. The tool is comparable with a single elementary part (cylinder), so $X=b=50\text{mm}$
3. The chart relating to this particular electrospindle is that in paragraph 6.7.2.3
4. You must refer to the red curve associated with "X"=50mm
5. Corresponding to the weight of 4.5kg, you can read the maximum speed, when empty, of 14000 rpm.

EXAMPLE 3

On an ES929 L ISO 30 SHORT NOSE, you want to use a pack of milling cutters comparable with a cylinder of diameter 100mm, length 600mm and overall weight 20kg:

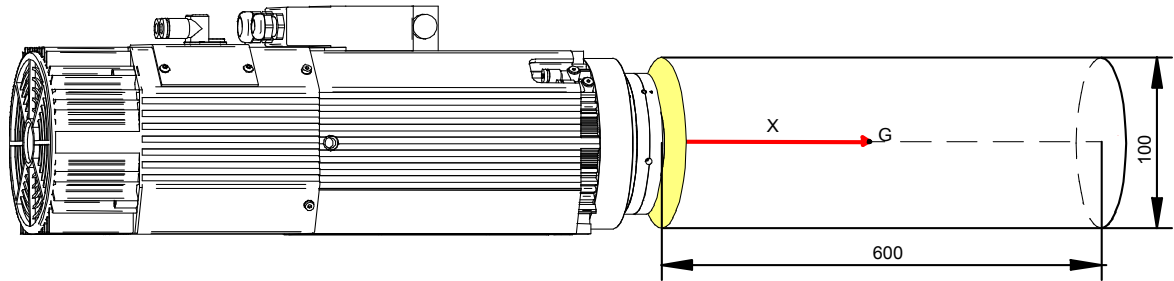

1. $b=h/2=600/2=300\text{mm}$
2. The tool is comparable with a single elementary part (cylinder), so $X=b=300\text{mm}$
3. The chart relating to this particular electrospindle is that in paragraph 6.7.2.5
4. The length and weight of the tool are outside the charts calculated by HSD. It will be the user's responsibility to evaluate the maximum speed at which to work

6.7.2.3 ES915 HSK F63 Long Nose

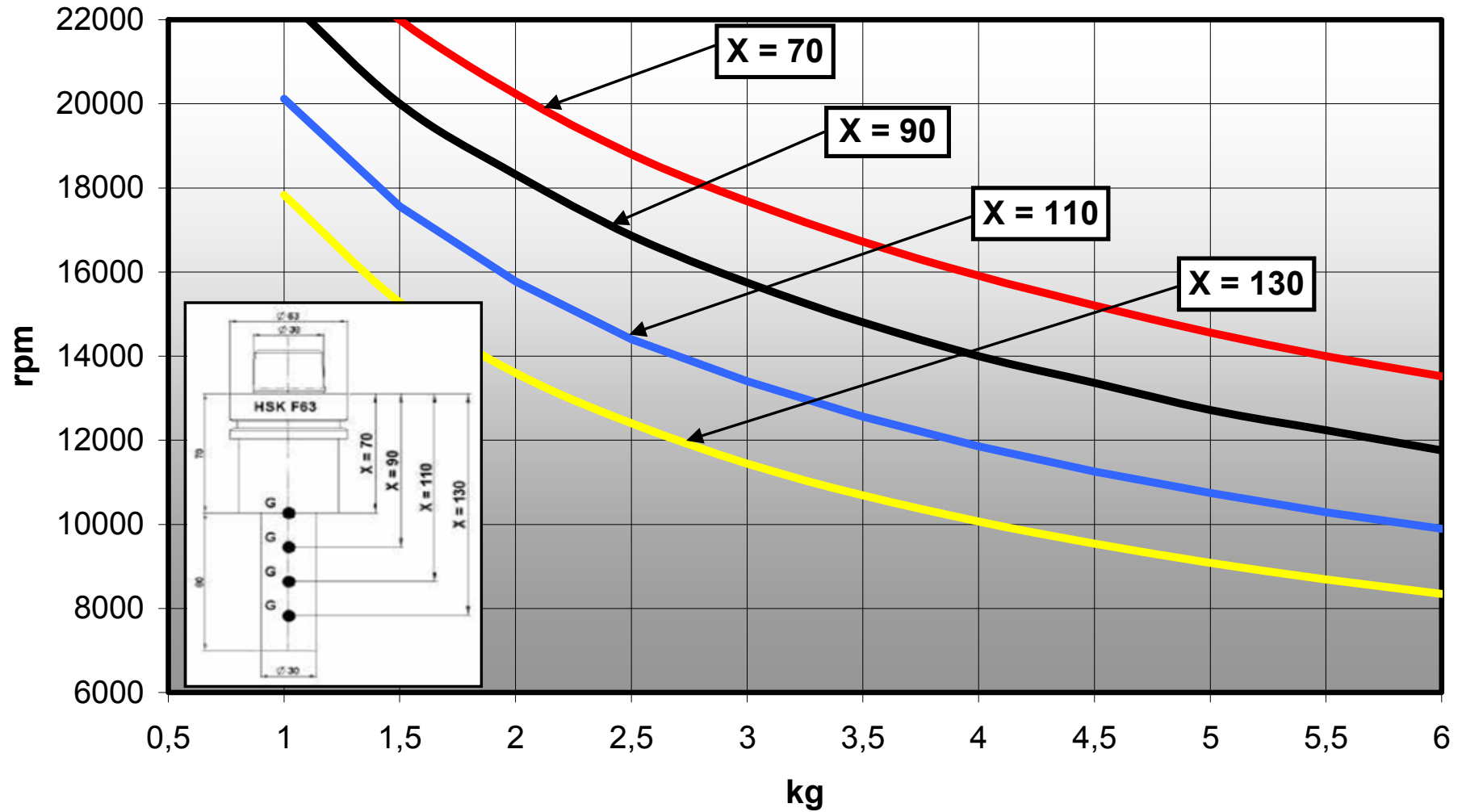

6.7.2.4 ES929 ISO30 Short Nose

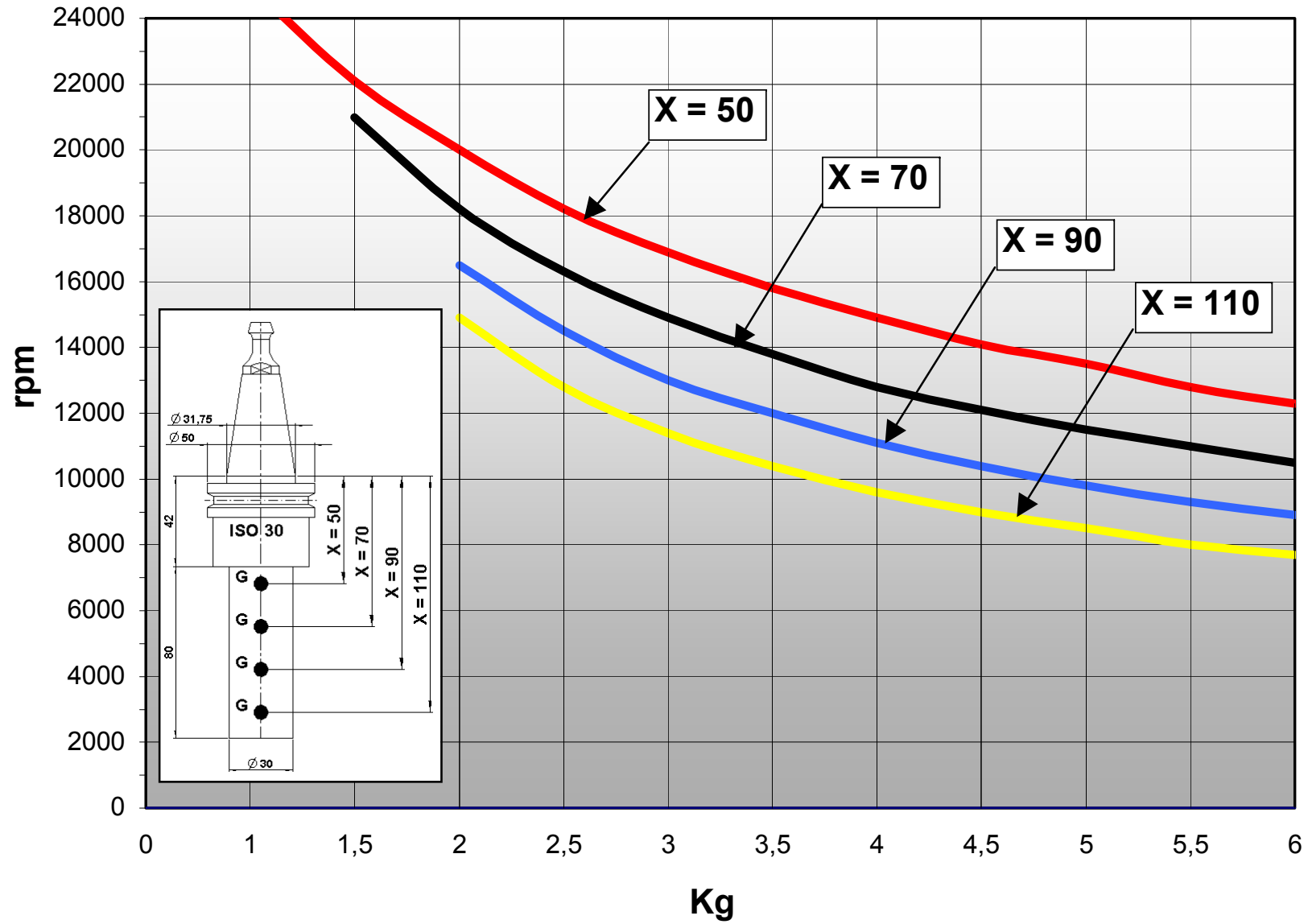

6.7.2.5 ES929 ISO30 Long Nose

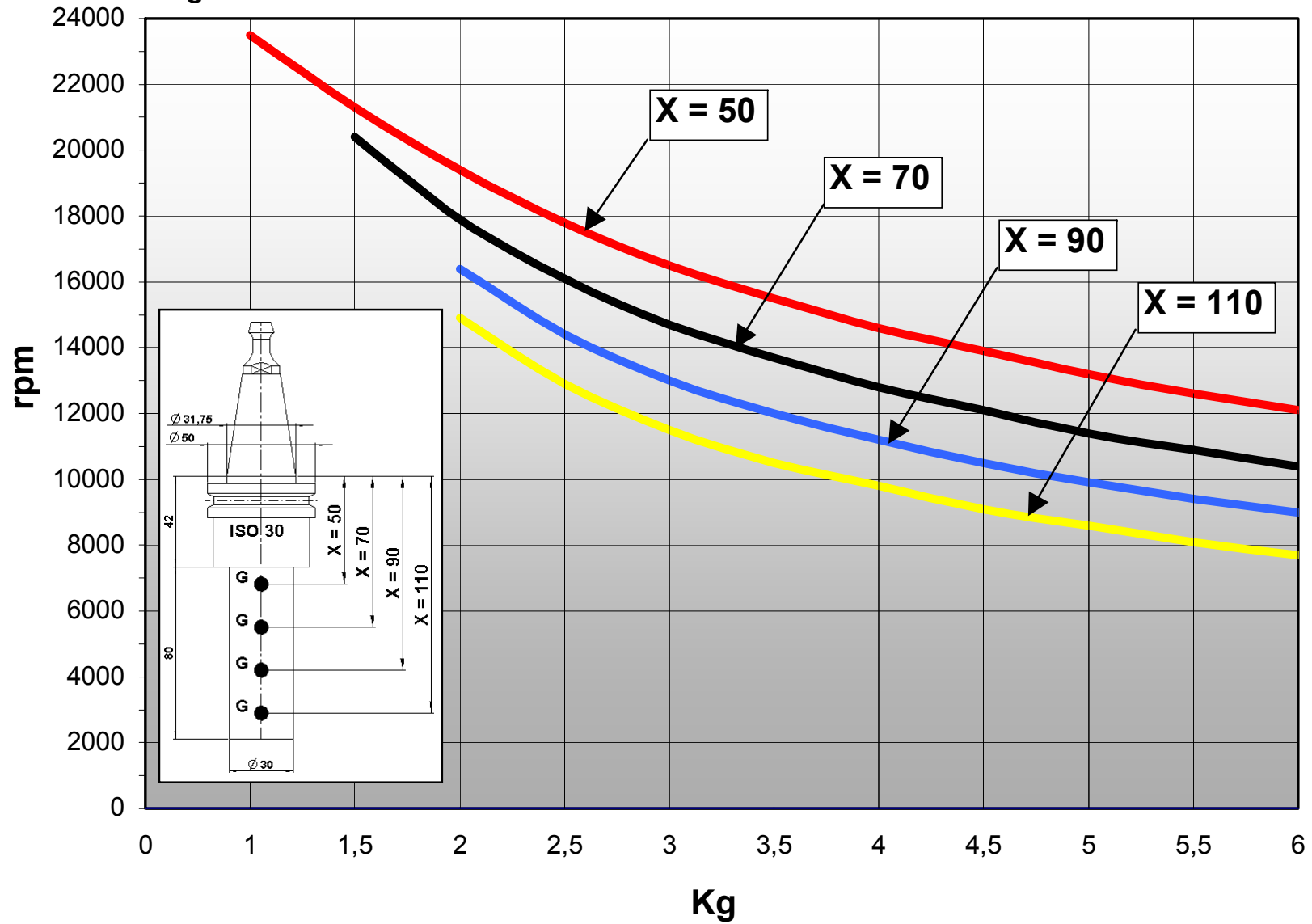

6.7.2.6 ES929 HSK F63 Short Nose

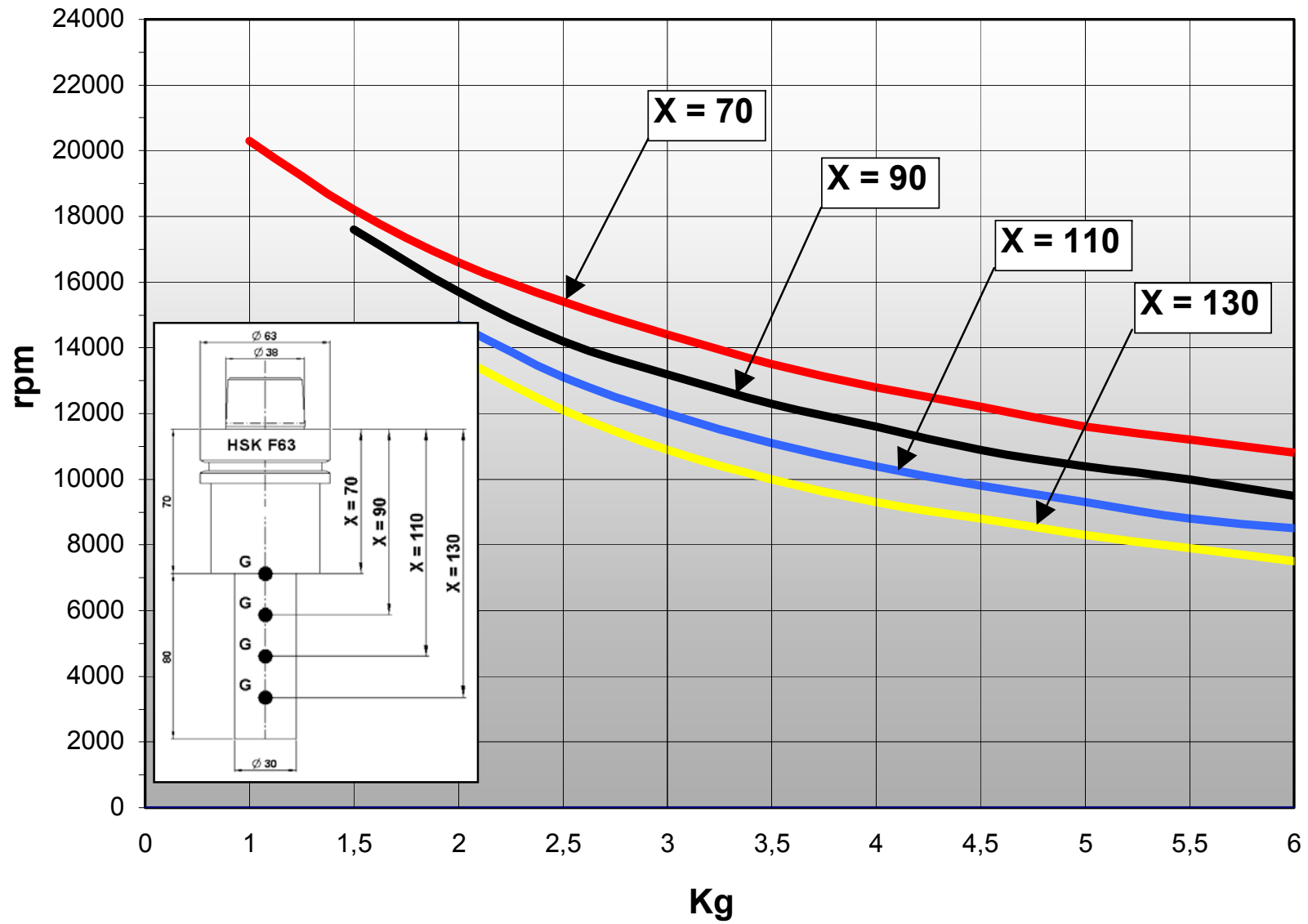

6.7.2.7 ES929 HSK F63 Long Nose

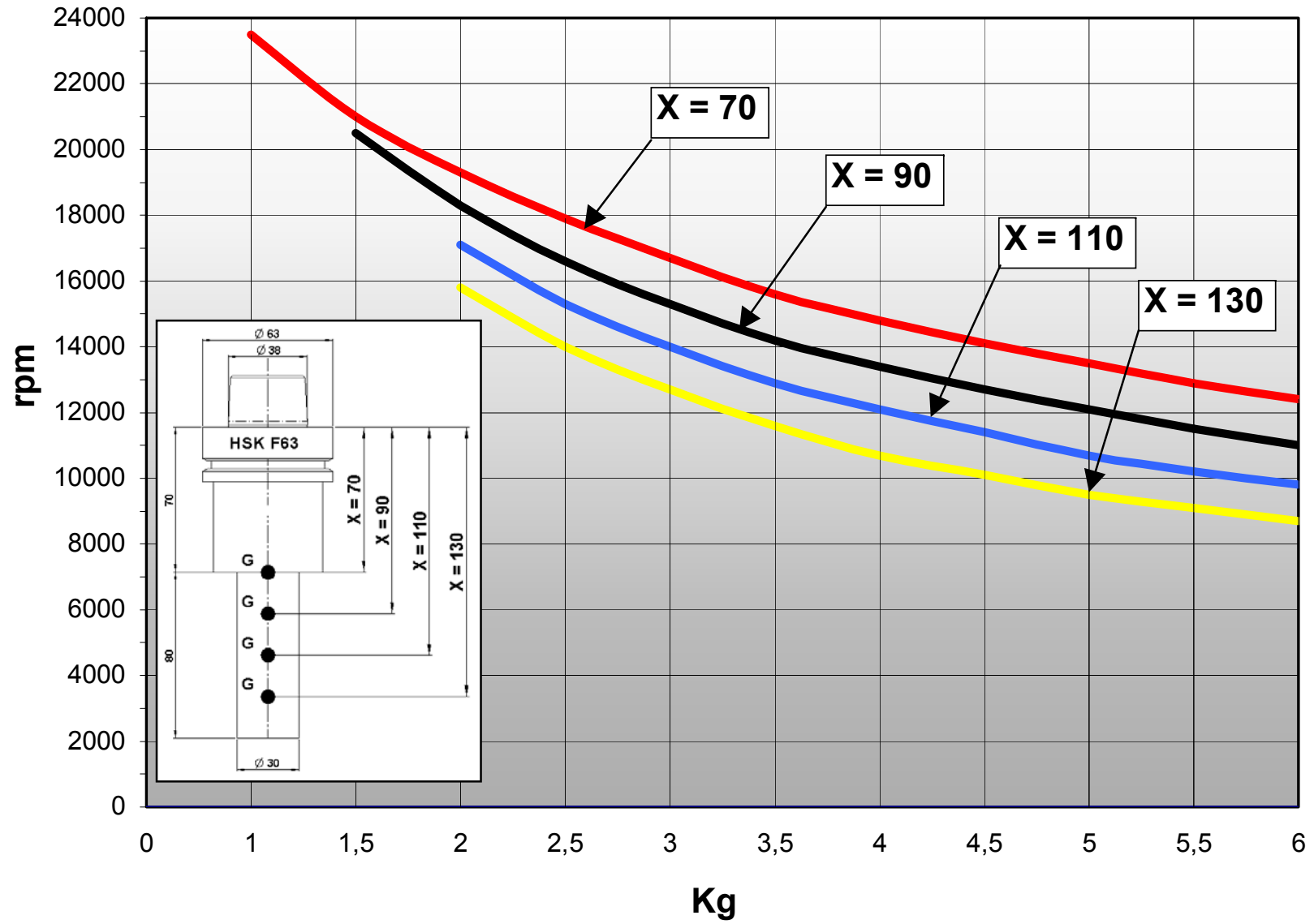

6.7.2.8 ES915 ISO30 Short Nose

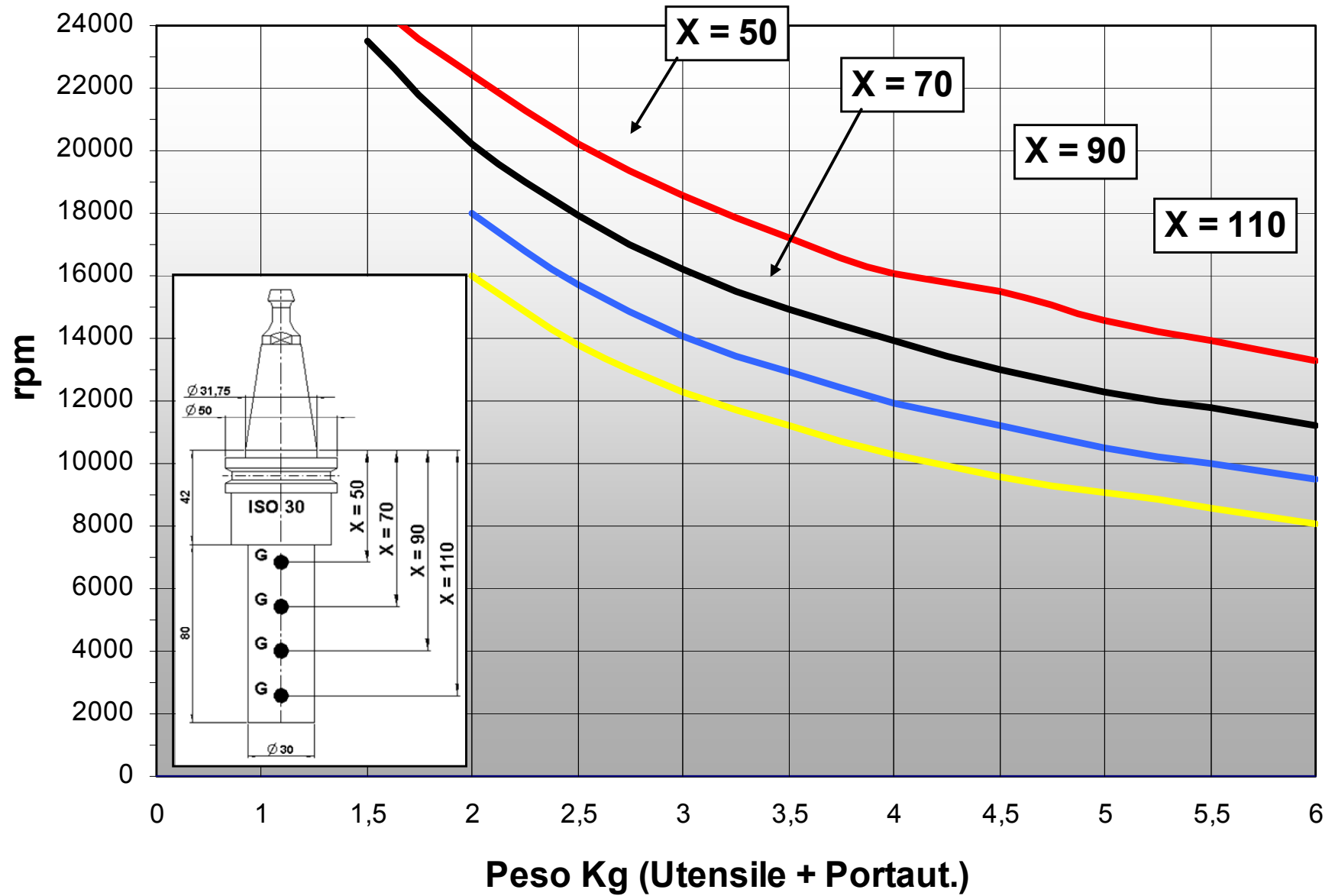

6.7.2.9 ES919, ES939 ISO30 Short Nose

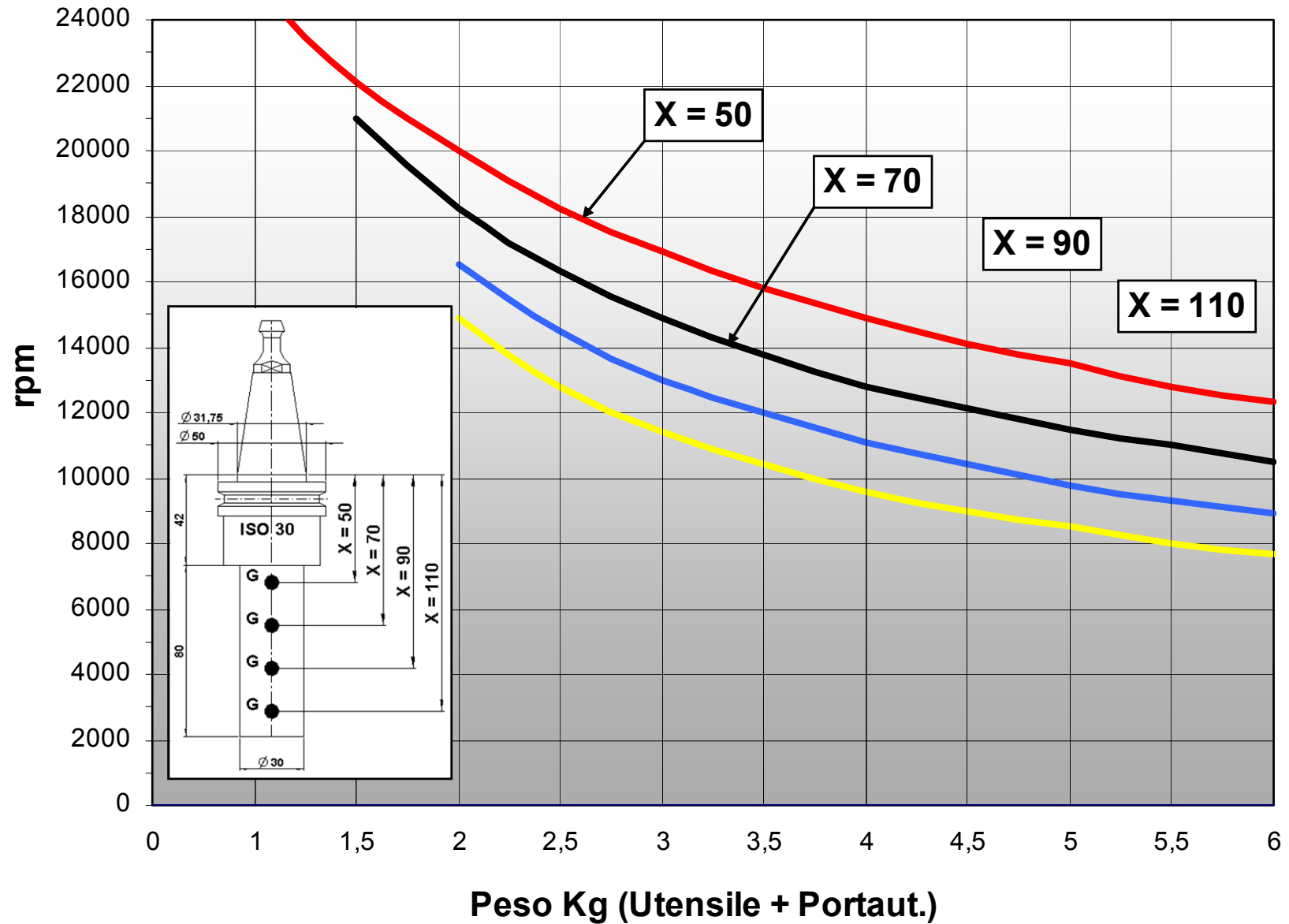

6.7.2.10 ES919, ES939 ISO30 Long Nose

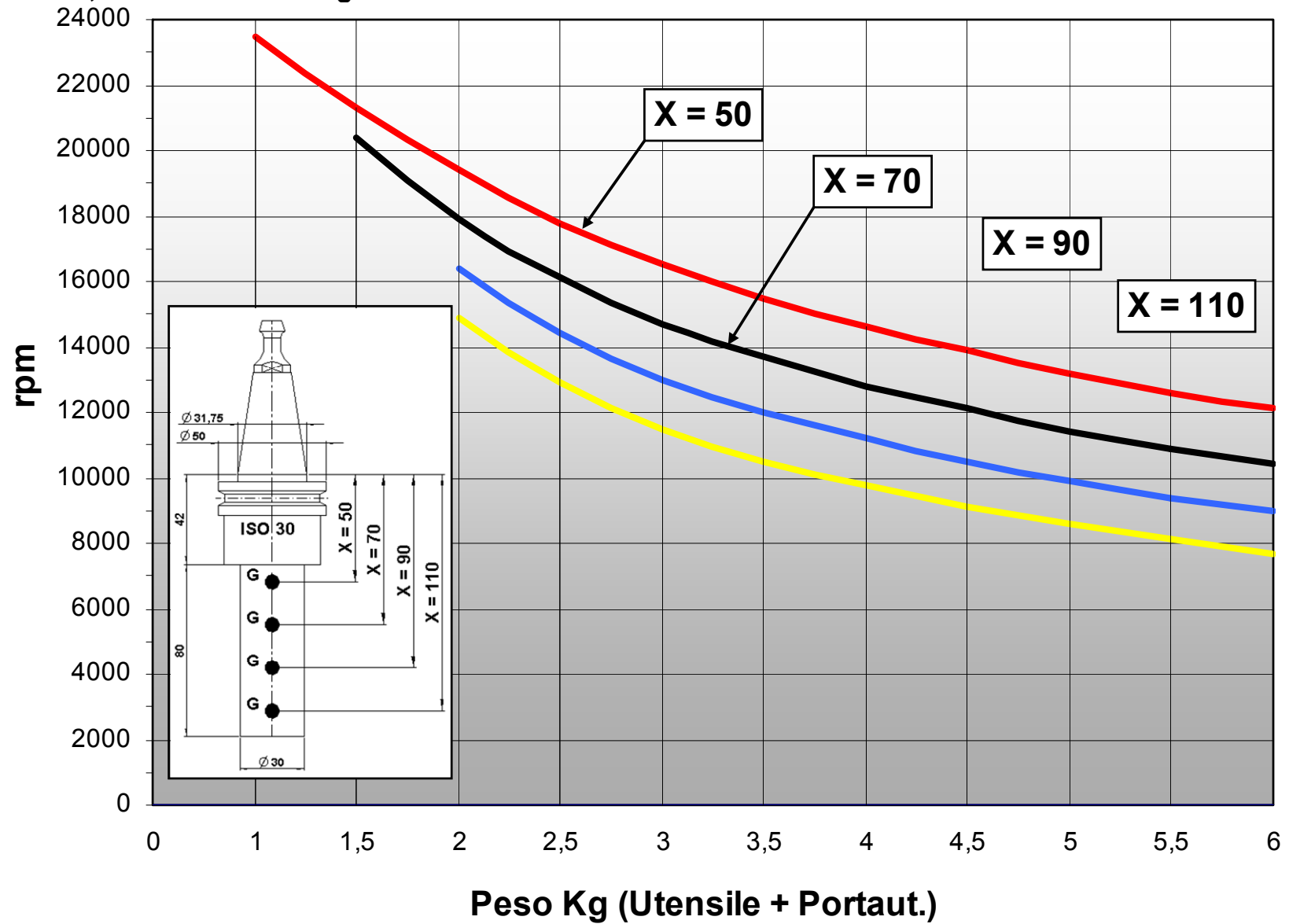

6.7.2.11 ES919, ES939 HSK F63 Short Nose

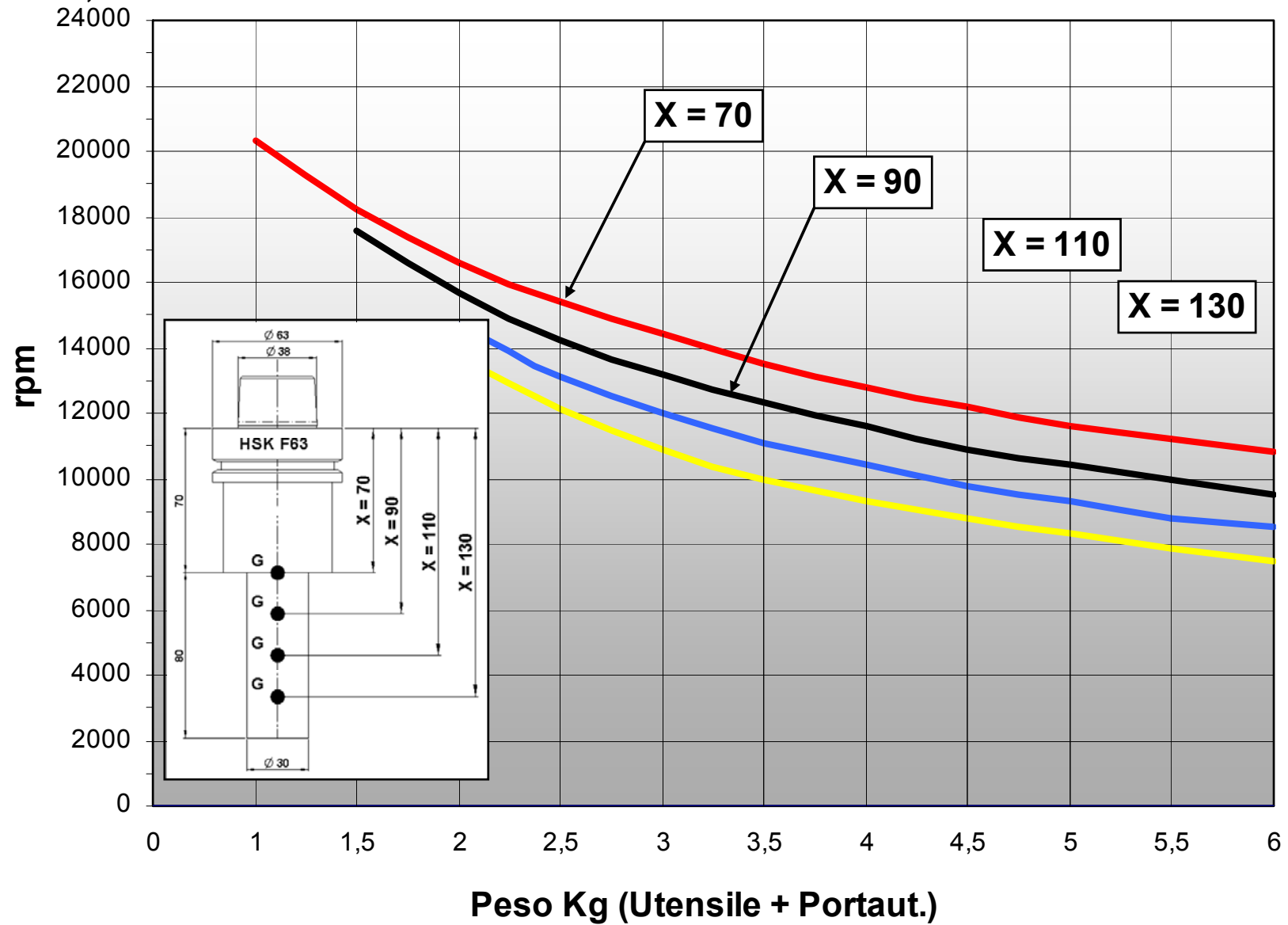

6.7.2.12 ES919, ES939 HSK F63 Long Nose

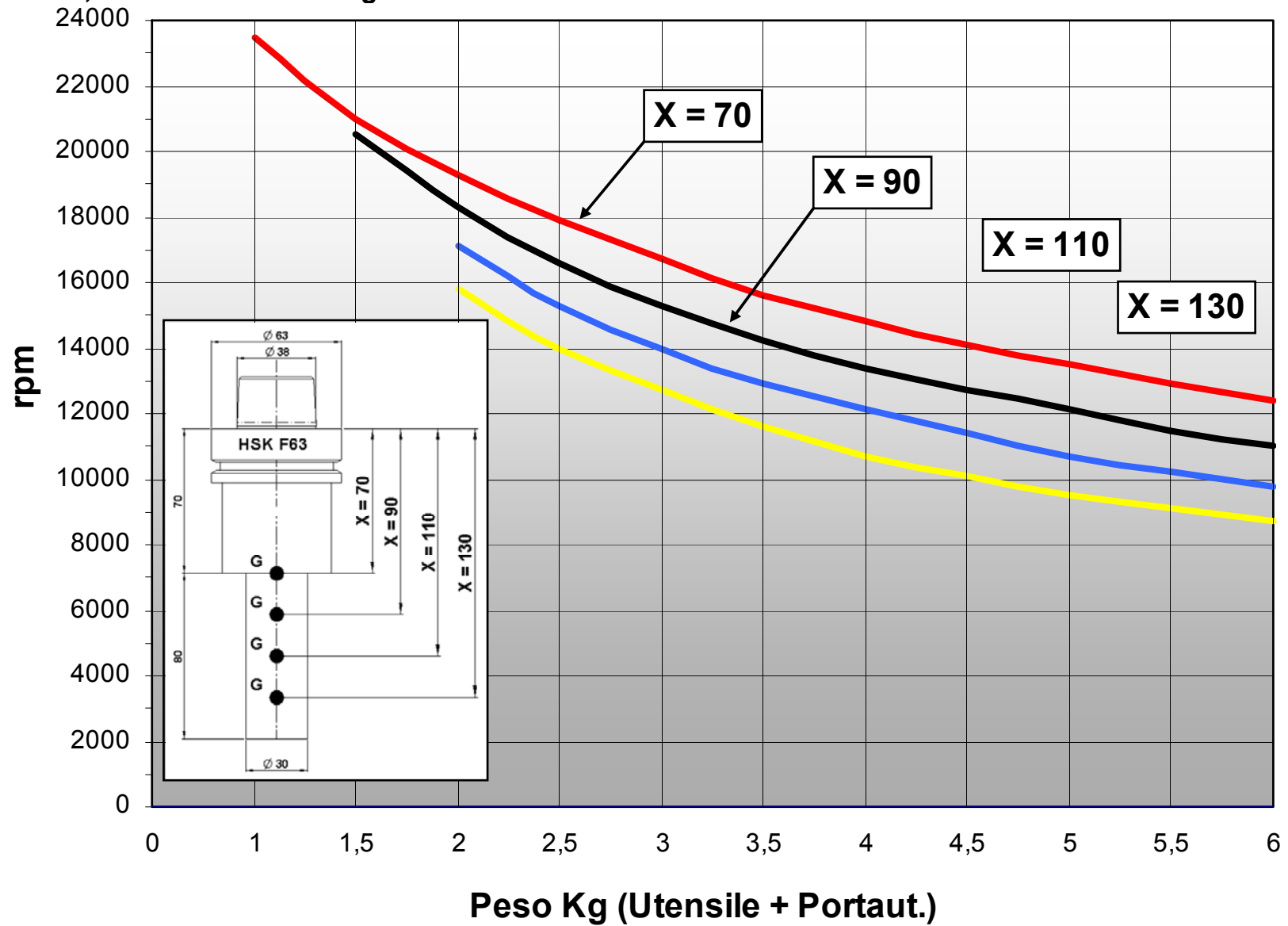

6.7.2.13 ES983 HSK E63 Long Nose

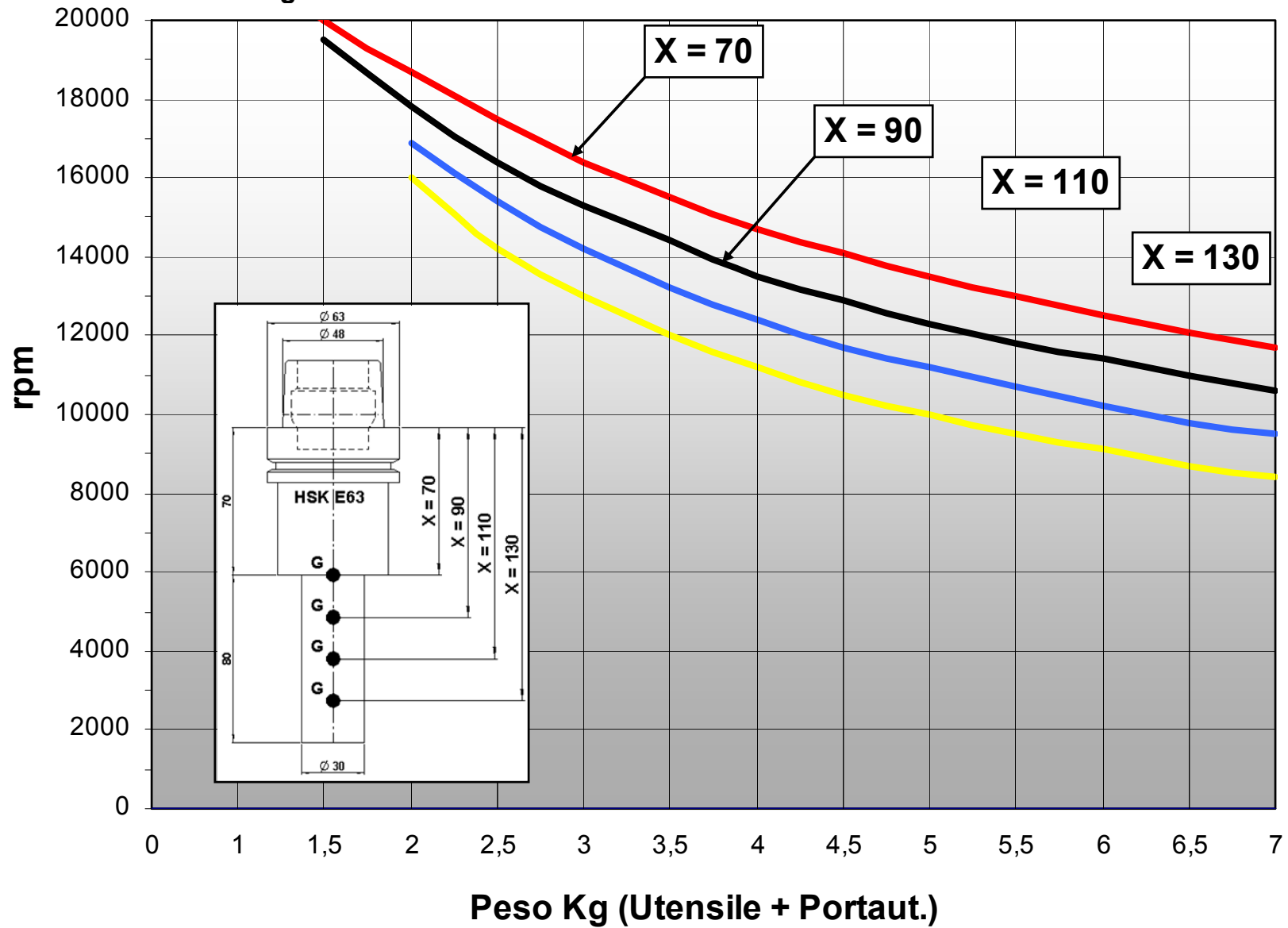

6.7.2.14 ES888/988 ISO 30 Short Nose

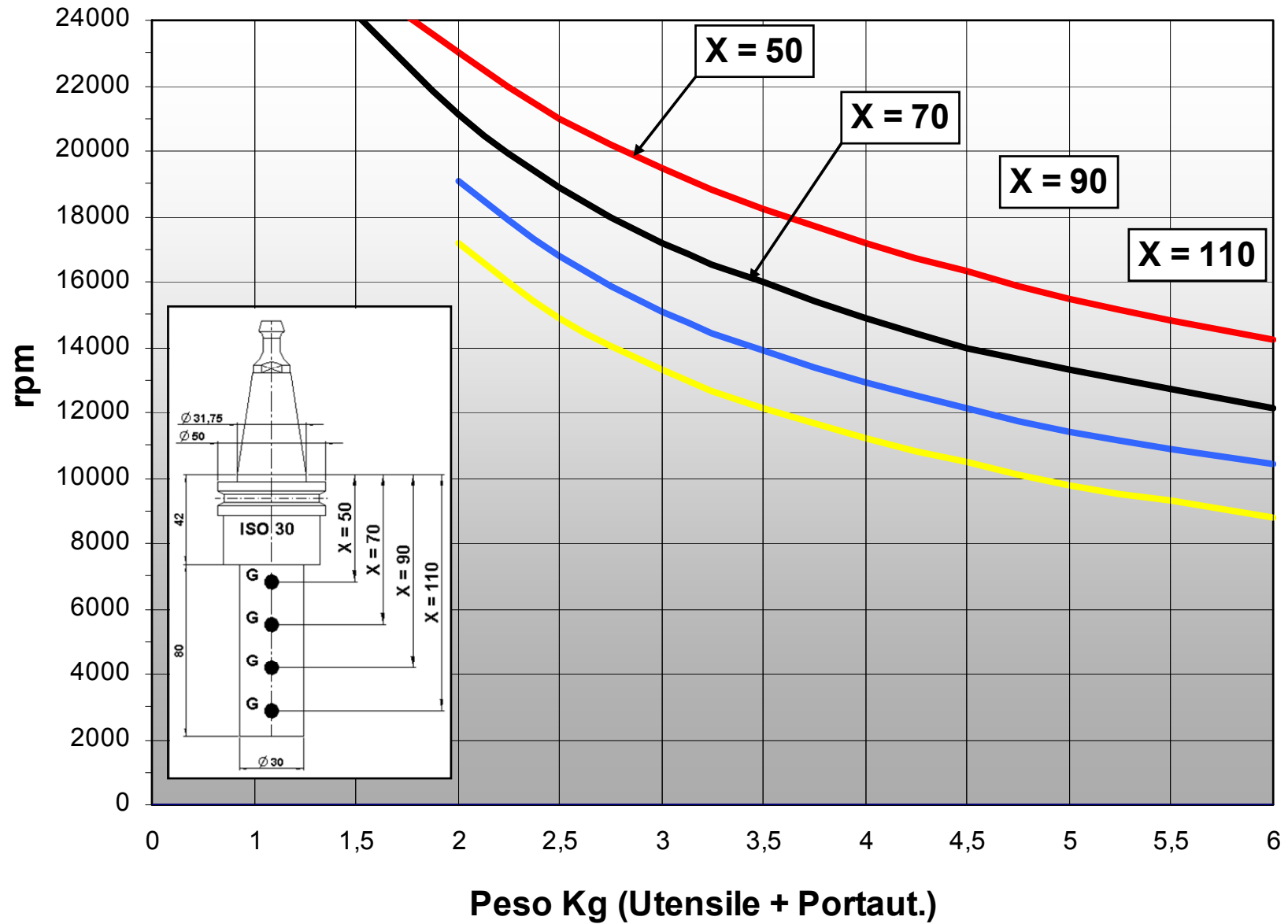

6.7.2.15 ES888/988 ISO 30 Long Nose

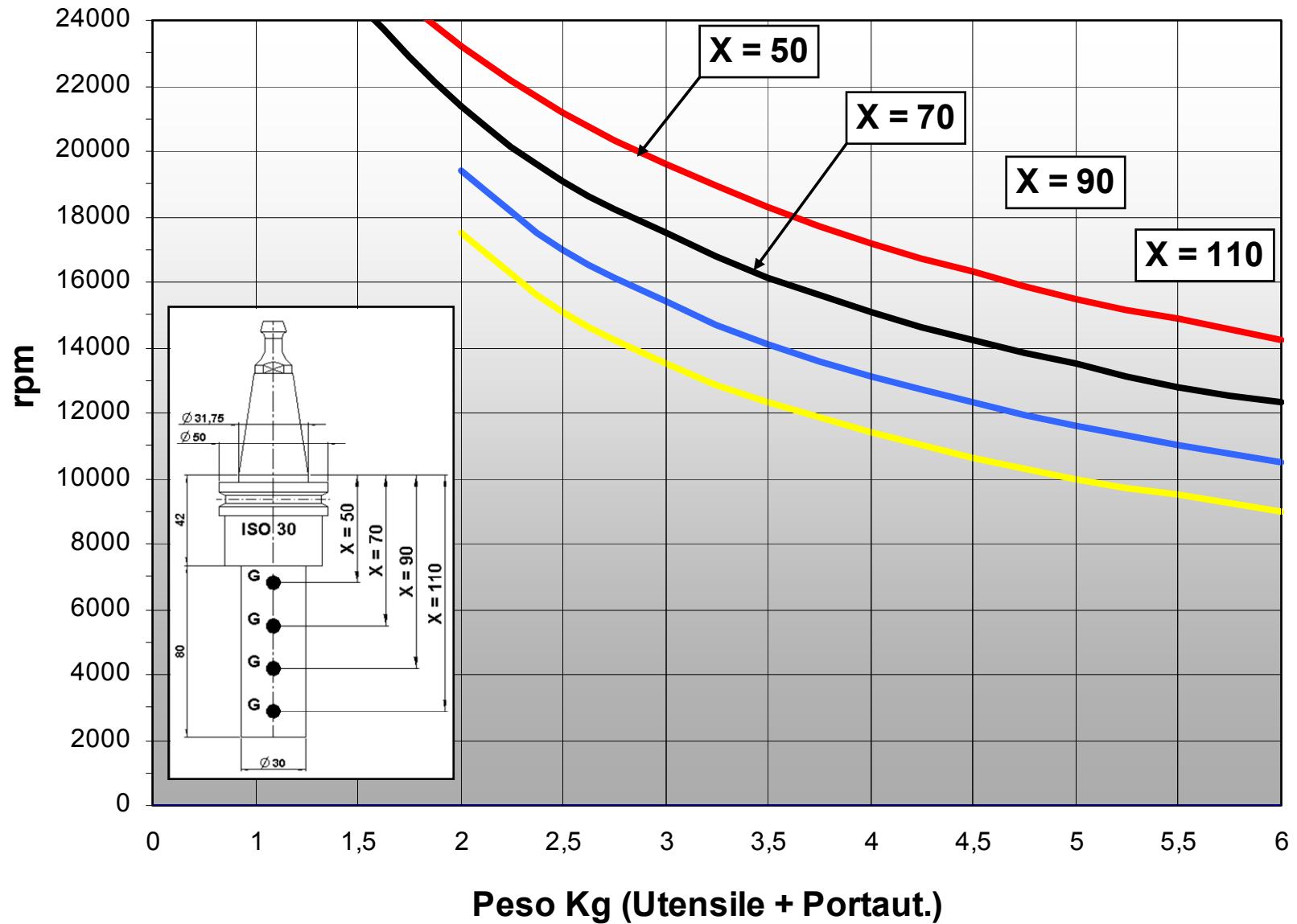

6.7.2.16 ES888/988 HSK F63 Short Nose

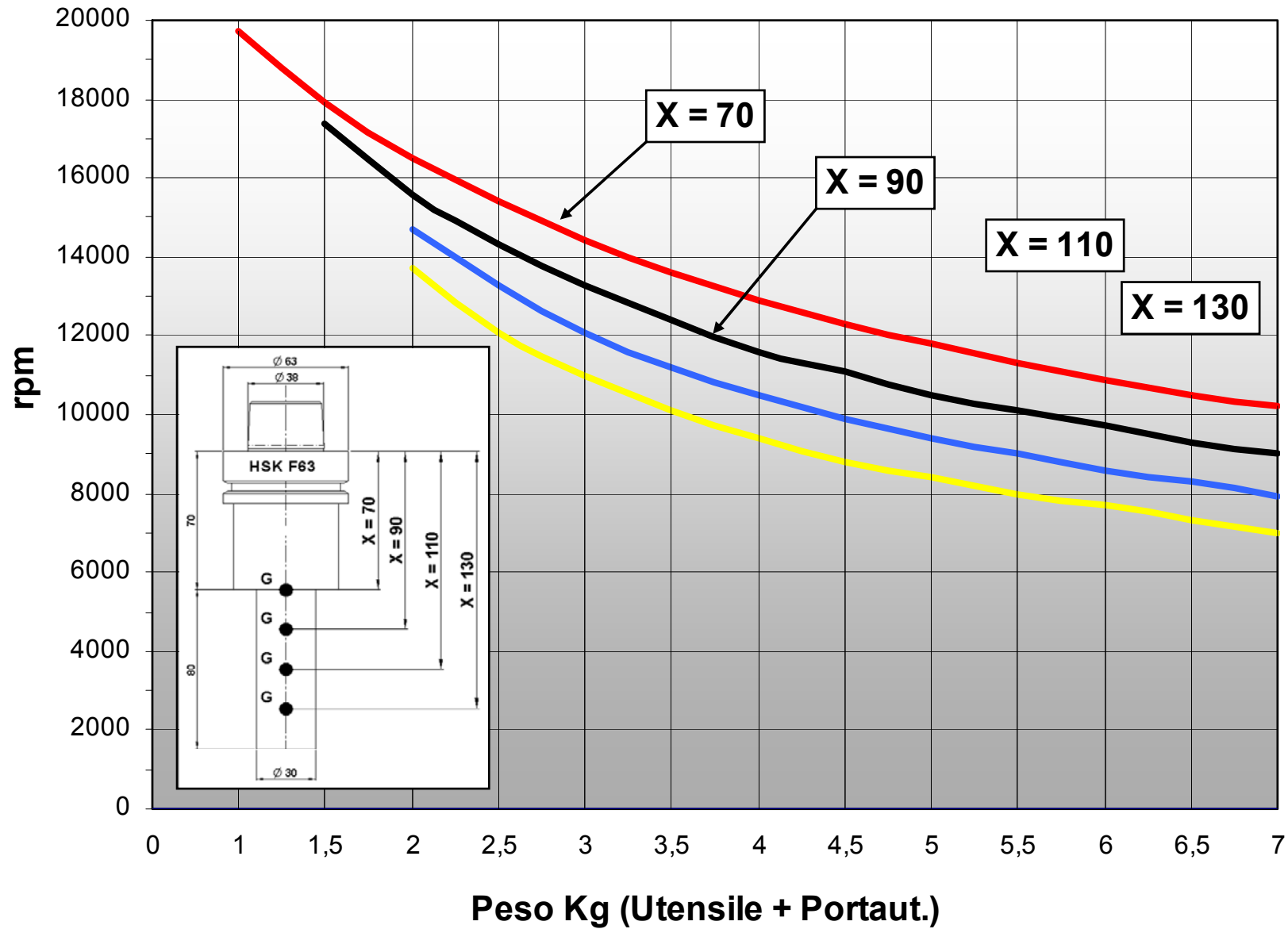

6.7.2.17 ES888/988 HSK F63 Long Nose

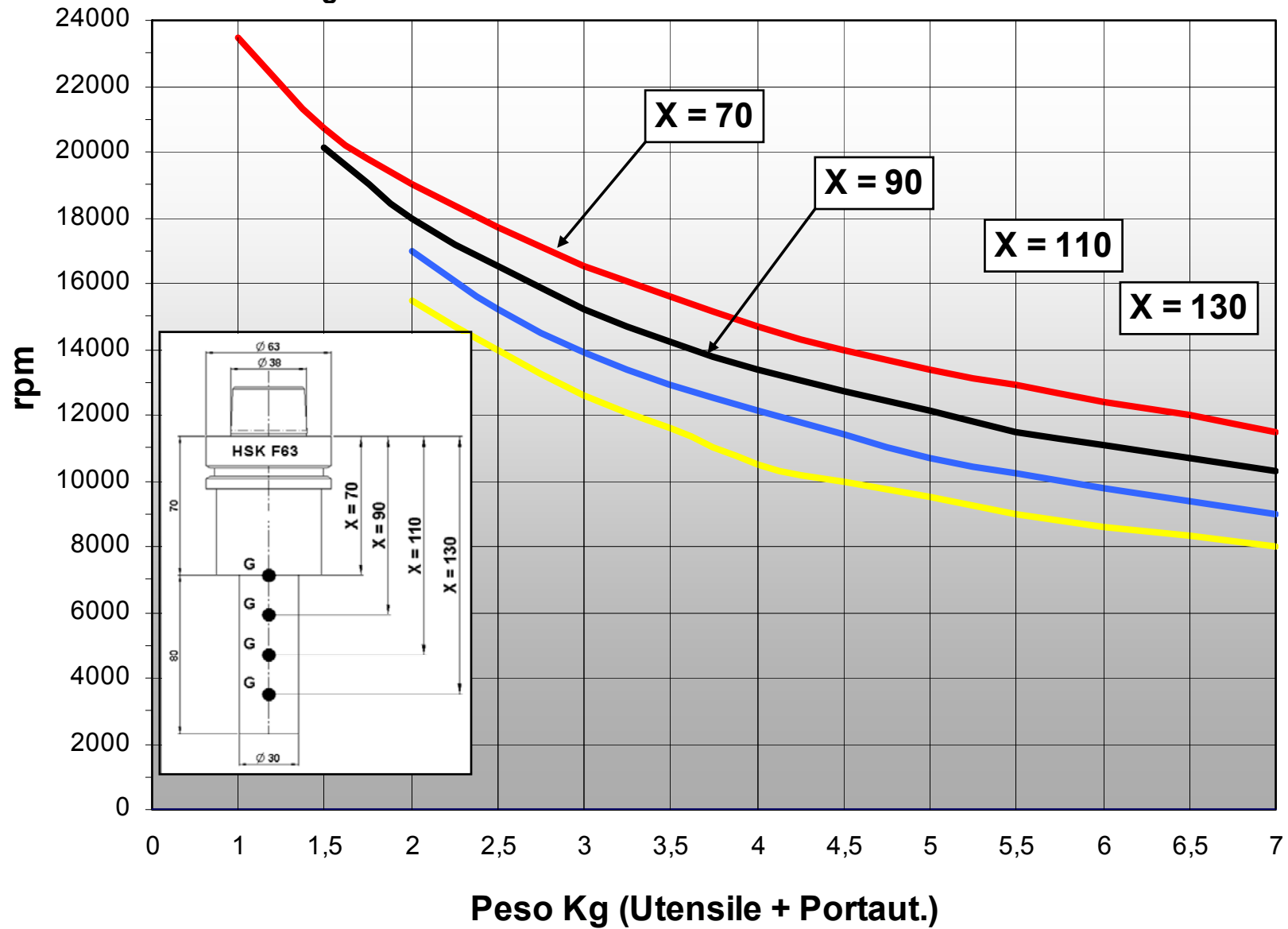

6.8 WHAT TO DO IF THE TOOL IS BLOCKED ON THE PIECE BEING WORKED



In the models with an ISO type tool hook-up, if the machine goes into emergency mode or stops with the tool blocked on the piece being worked, do not move the spindle along the Z-axis!

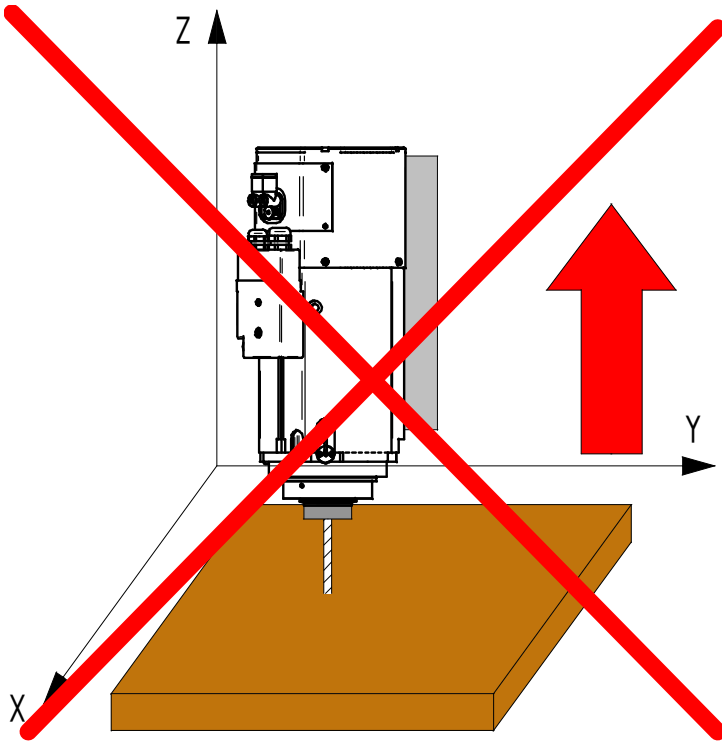

If possible, release the piece manually and then carry out the tool changing manually.

If this is not possible, proceed in the following way:

- Supply air to the tool changing circuit
- Slowly move the spindle away from the piece, moving it along the Z-axis until the collet opens ("ON" output of sensor S2)
- Check the collet spindle has been freed from the collet
- Move the spindle completely away from the piece being worked
- Remove the blocked tool manually.

HSD

If these procedures are not observed, the tool-holder will drag the locking system (collet/tie-rod) with it until the collet spindle is freed; owing to the force of the spring, the collet will then shoot back violently, perhaps breaking the tie-rod

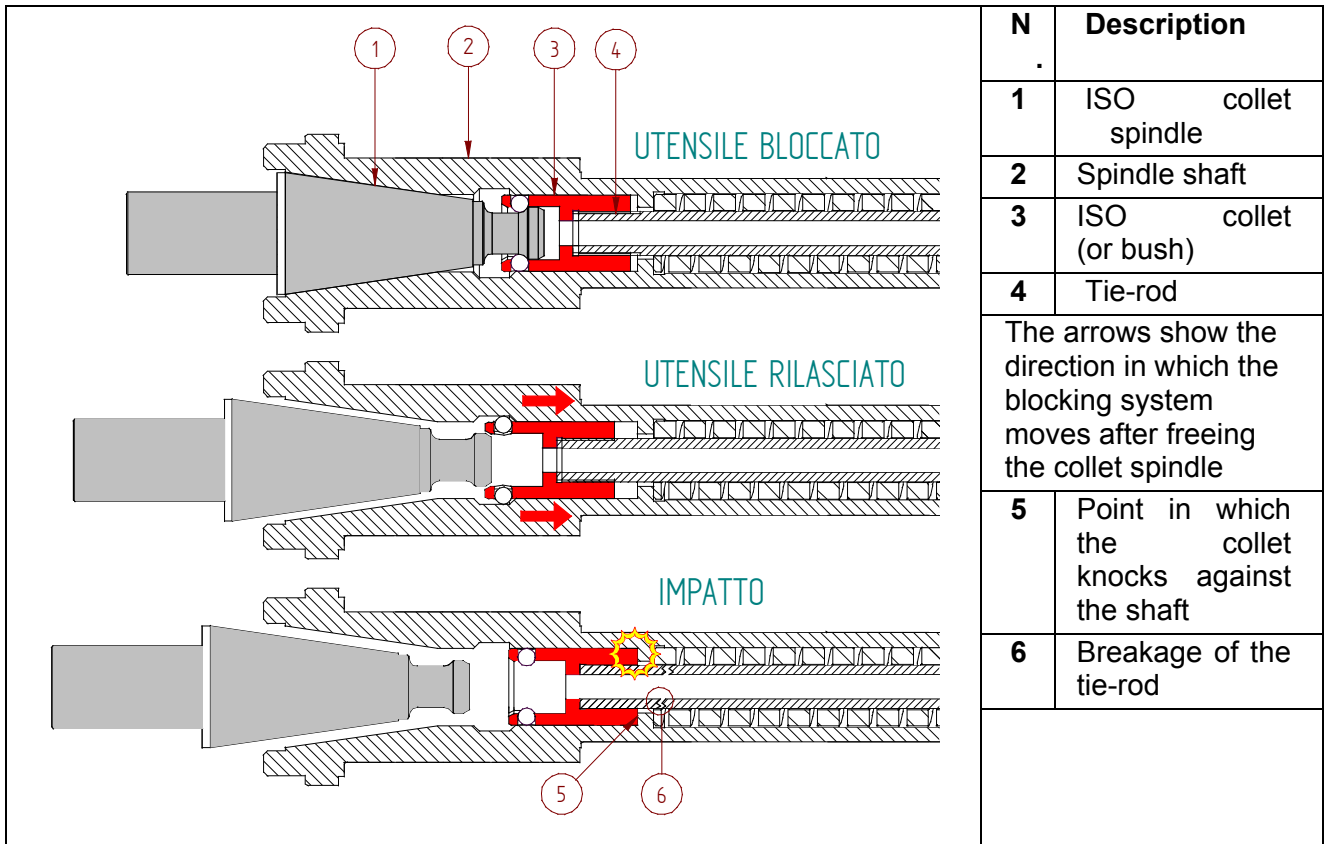

6.9 SENSORS

The electrospindle is equipped with inductive sensors for monitoring its status, and a “thermal alarm” to protect the electric coils.

NAME	SENSOR INFORMATION
S1	<i>Tool-holder cone attached</i>
S2	<i>Collet open</i>
S3 (*)	<i>Shaft stopped</i>
S4 (**)	<i>HSK cone blocked in correct position</i>
S5 (***)	<i>Piston at upper end stop</i>
Thermal alarm	<i>Engine overheated: stop the electrospindle!</i>

(*) *Not present in certain versions*

(**) *In HSK versions only*

(***) *Only on models with double-acting piston*

6.9.1 Technical characteristics of the inductive sensors

Type Proximity PNP normally open (NO)	
<i>Supply voltage</i>	<i>10 - 30V (DC)</i>
<i>Maximum load</i>	<i>200 mA</i>
<i>Power consumption with no load</i>	<i><10 mA</i>
<i>Nominal detection distance</i>	<i>0.8mm</i>

6.9.2 Status modes of the electrospindle and corresponding outputs



The “ON” condition corresponds to an output equal to the supply voltage of the sensors; the “OFF” condition corresponds to an output of 0V.

	<i>ISO versions</i>	<i>HSK versions</i>		
STATE	S1+S5(*)	S1+S4+S5(*)	S2	S3 (*)
<i>Collet open</i>	<i>OFF</i>	<i>OFF</i>	<i>ON</i>	<i>IDLE</i>
<i>Collet closed but tool-holder cone absent</i>	<i>OFF</i>	<i>OFF</i>	<i>OFF</i>	<i>IDLE</i>
<i>Tool-holder cone blocked correctly</i>	<i>ON</i>	<i>ON</i>	<i>OFF</i>	<i>IDLE or STARTED UP (**)</i>
(*) S3 and S5 not present on some versions (**) Depending on the operating status of the machine				



The shaft of the electrospindle can only be rotated in the “**Tool-holder cone blocked correctly**” state; if the outputs of S1+S5 or S1+S4+S5 move to “OFF”, stop the electrospindle shaft rotation.

6.9.3 Output of sensor S3: “shaft idle” signal

Sensor S3 supplies two “ON” pulses and two “OFF” pulses at each rotation of the shaft, as shown in the figure below.

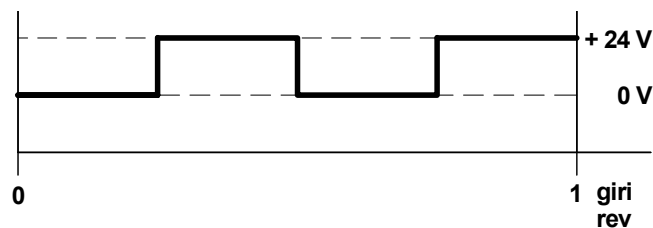

Above a certain speed range, the output of S3 may appear to be permanently "ON", returning to normal when the speed falls below this threshold. This phenomenon is not a malfunction and depends on the performance of the CNC.



Ignore the S3 signal during the tool changing phase, during which it may appear to be in either of the two states (“ON” or “OFF”)



The S3 sensor is not present in certain versions.

6.9.4 Use and technical characteristics of the thermal alarm

The electrospindle is equipped with a bimetallic normally-closed switch, inserted in the electric coils of the stator, which opens when a temperature that is harmful for the electric coils is reached; the contact closes automatically when the temperature drops and returns to safe values.

The thermal alarm must be connected to the numerical control, which in turn must stop the machining operations as quickly as possible and stop the rotation of the shaft of the electrospindle, if the switch opens.



If the shaft blocks while the tool is still being pushed against the piece being worked, the bearings of the spindle could break; if you wait too long before moving the tool away from the piece and stopping the rotation, the stator could be burnt.

6.9.4.1 Technical characteristics of the bimetallic switch:

Power supply	48V DC MAX
Current	1.6A MAX
Switching cycles	10,000 cycles
Contact breaking time	< 1 ms
Contact resistance (according to MIL R 5757)	< 50 mΩ
Insulation voltage	2 kV

6.9.4.2 Motor Thermistor

In some versions could be inserted a PTC thermistor in the stator windings to monitor temperature. Electrical resistance from the thermistor increases rapidly as it reaches trip temperature (normally 100°C or 130°C depending on the model).

The signal from the thermistor must be fed to a control device to stop the machine in order to protect the electro-spindle from the effects of overheating.

Thermistor trip temperature depends on the model of electro-spindle. (See data sheet)

The thermistors used in these electro-spindles comply with DIN 44081-44082 standards.

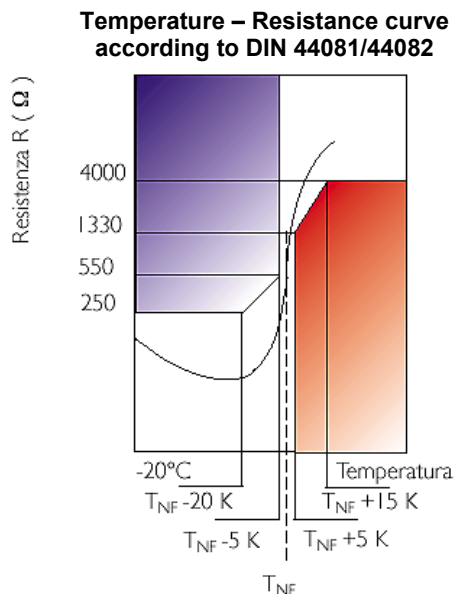

Main specifications

Nominal trip temperature T_{NF} = from 50°C to 200°C in steps of 10K or 5K		
Characteristic values for PTC thermistors	Resistance	Measurement voltage
Resistance in temperature range from -20°C to $T_{NF} - 20\text{ K}$	20 to 250Ω	≤ 2.5 V-
Resistance at $T_{NF} - 5\text{ K}$	≤ 550Ω	≤ 2.5 V-
Resistance at $T_{NF} + 5\text{ K}$	≥ 1330Ω	≤ 2.5 V-
Resistance at $T_{NF} + 15\text{ K}$	≥ 4000Ω	≤ 7.5 V- pulse

Figure 6.3

6.10 ENCODER (OPTIONAL)

6.10.1 General description

The encoder codes in an incremental system the registered position data with A and B, A negated and B negated signals.

The signals are in phase quadrature; that is to say the A, B, A- and B- signals are out of phase 90 degrees between them.

The encoder also provides Zero and Zero negated signals.

The output is taken to the electrospindle "signals connector" (section 4.6.1).

There are three models of encoder available:

- HSD "Square Wave" type;
- Lenord+Bauer "Square Wave" type;
- Lenord+Bauer "Sinusoidal" type.

6.10.2 Technical characteristics of the HSD Square Wave encoder

SPECIFICATION	VALUE
Rated electrical power:	12V DC - 24V DC $\pm 10\%$
Consumption:	99 mA with 12V DC 51 mA with 24V DC
Operating temperature	0°C - 70°C (32° F - 158° F)
Max operating altitude:	2000m (6500ft)
Signal input:	400 pulses per rev + zero reference
Signal output:	TTL-level compatible (0V, +5V line driver)

6.10.3 Output of the HSD Square Wave encoder

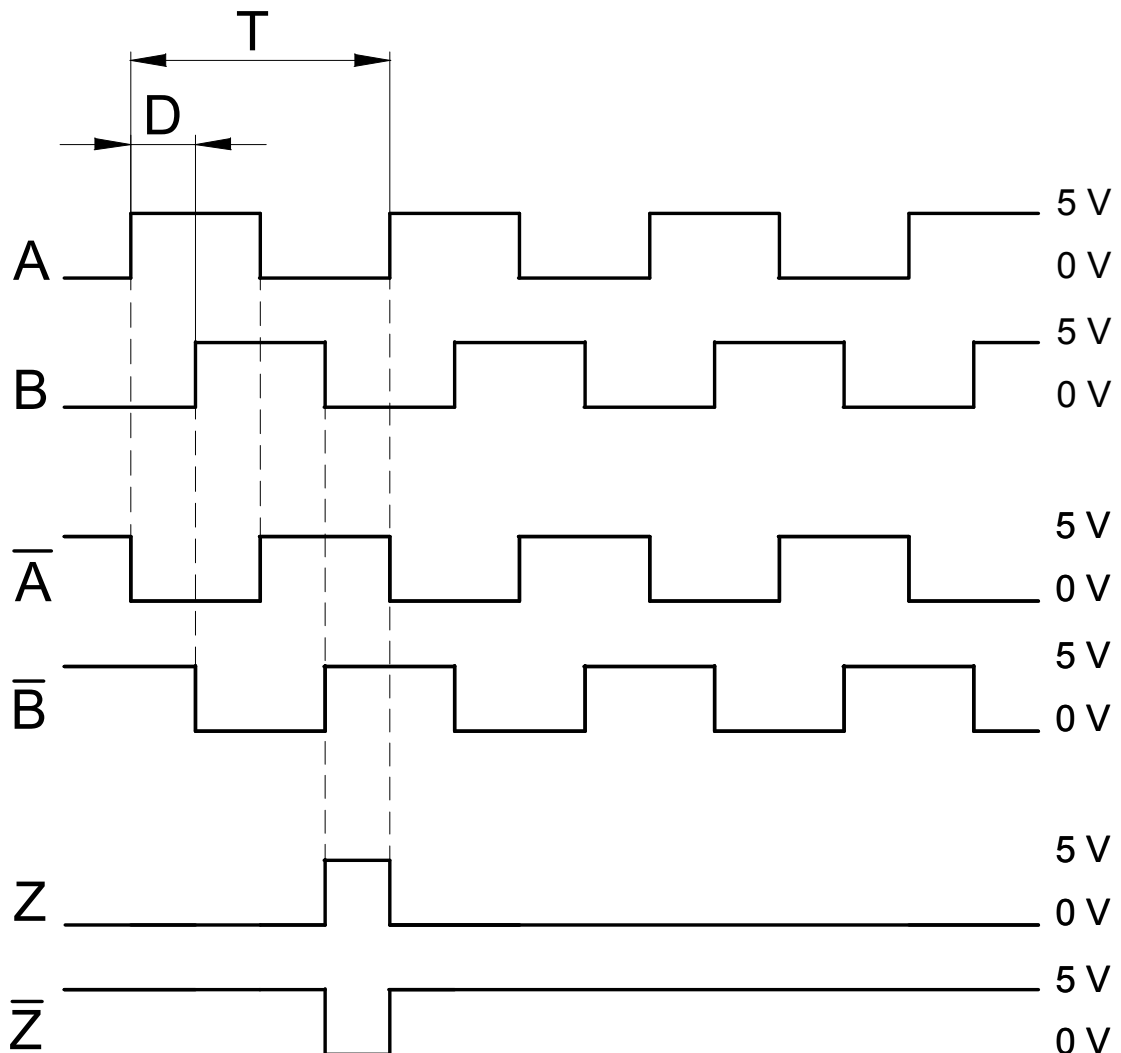

T	Period
D	Phase Difference ($D=T/4$)

HSD

6.10.4 Technical characteristics of the Lenord+Bauer Square Wave encoder

SPECIFICATION	VALUE
Rated electrical power:	5V DC $\pm 5\%$
Operating temperature	-30°C - 85° C (-22°F - 185°F)
Max operating altitude:	2000m (6500ft)
Signal input:	512 pulses per rev + zero reference (128 pulses multiplied internally by 4)
-Signals output:	TTL-level compatible (0V, +5V line driver)

6.10.5 Output of the Lenord+Bauer Square Wave encoder

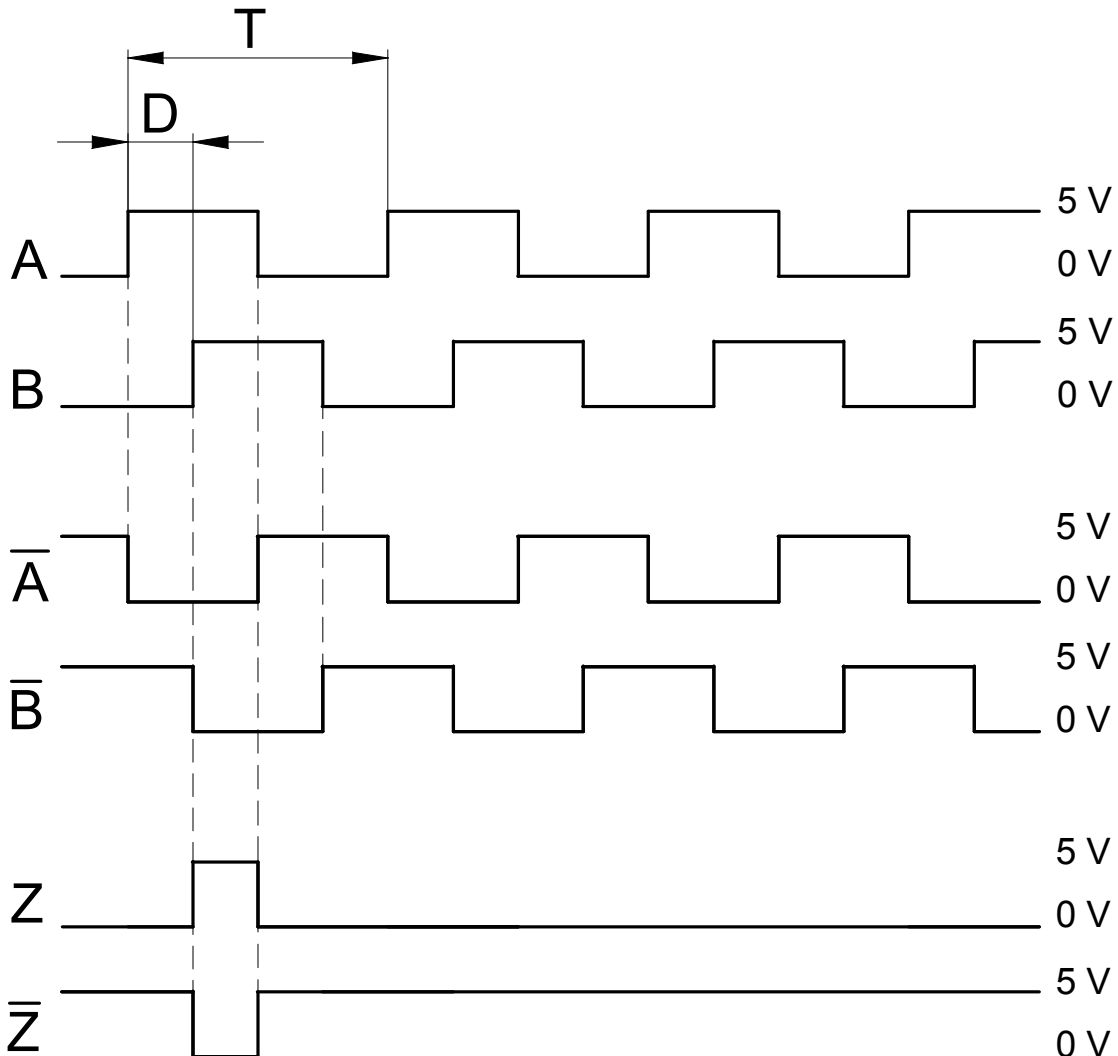

6.10.6 Technical characteristics of the Lenord+Bauer sinusoidal encoder

SPECIFICATION	VALUE
"U" rated supply voltage	5V DC $\pm 5\%$
Operating temperature	-30°C - 85°C (-22°F - 185°F)
Max. operating height	2000m (6500ft)
Signal input	128 pulses per rev + zero reference
A B signal output	500 mV peak-to-peak with average value "U ref."= $U/2$ 1 V peak-to-peak as difference of signals with average value "U ref." (see figures below)
A B signal phase difference	90° (a quarter of period)
Z signal output	500 mV peak compared with resting value U ref. $\pm 80\text{mV}$ 1 V peak as difference of signals with resting value U ref. $-160\text{mV} = 2.34\text{V}$ (see figures below)

A signal temporal performance:

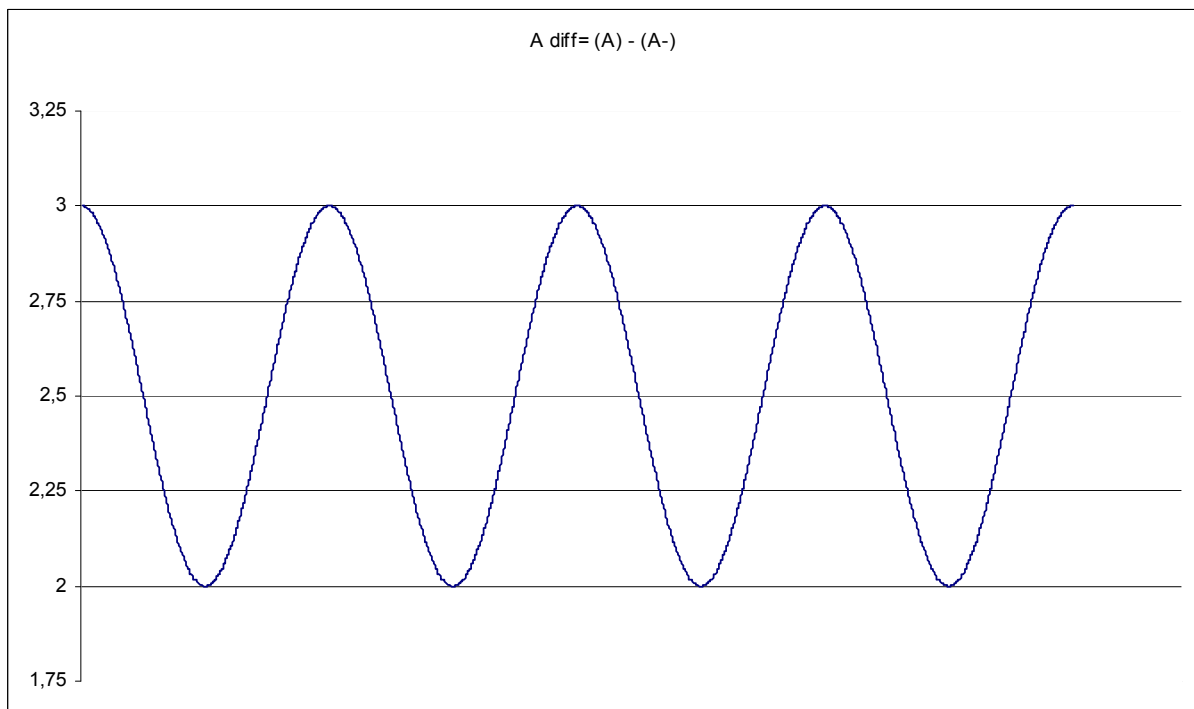
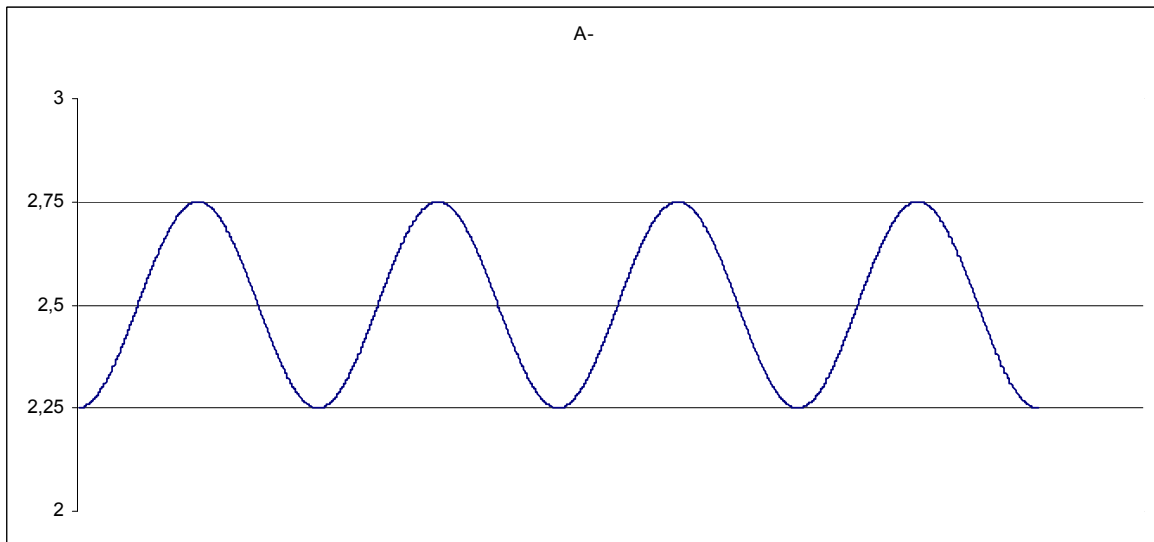
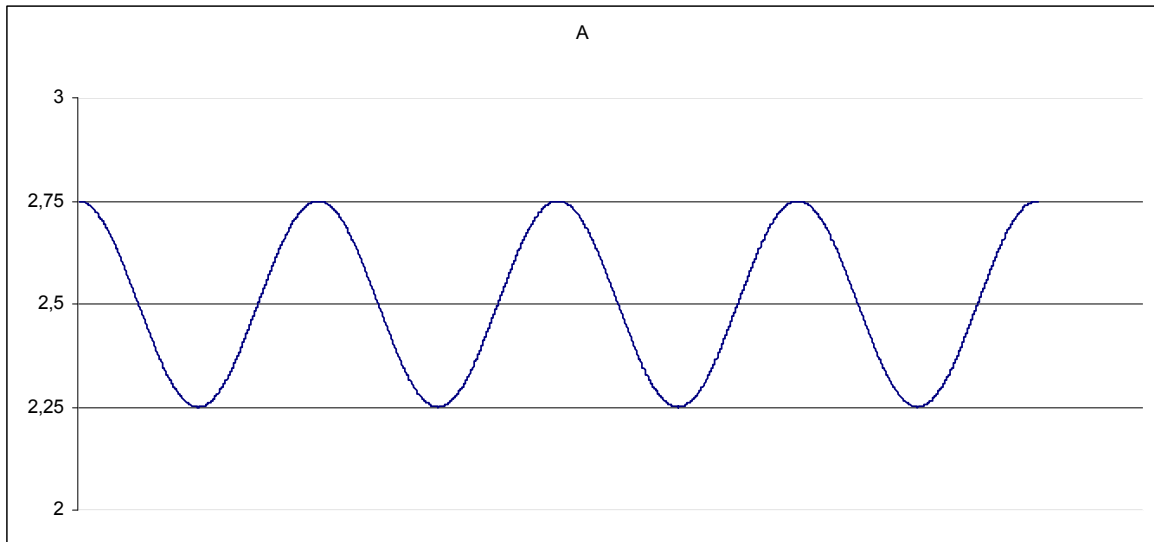

HSD

A signal temporal performance:

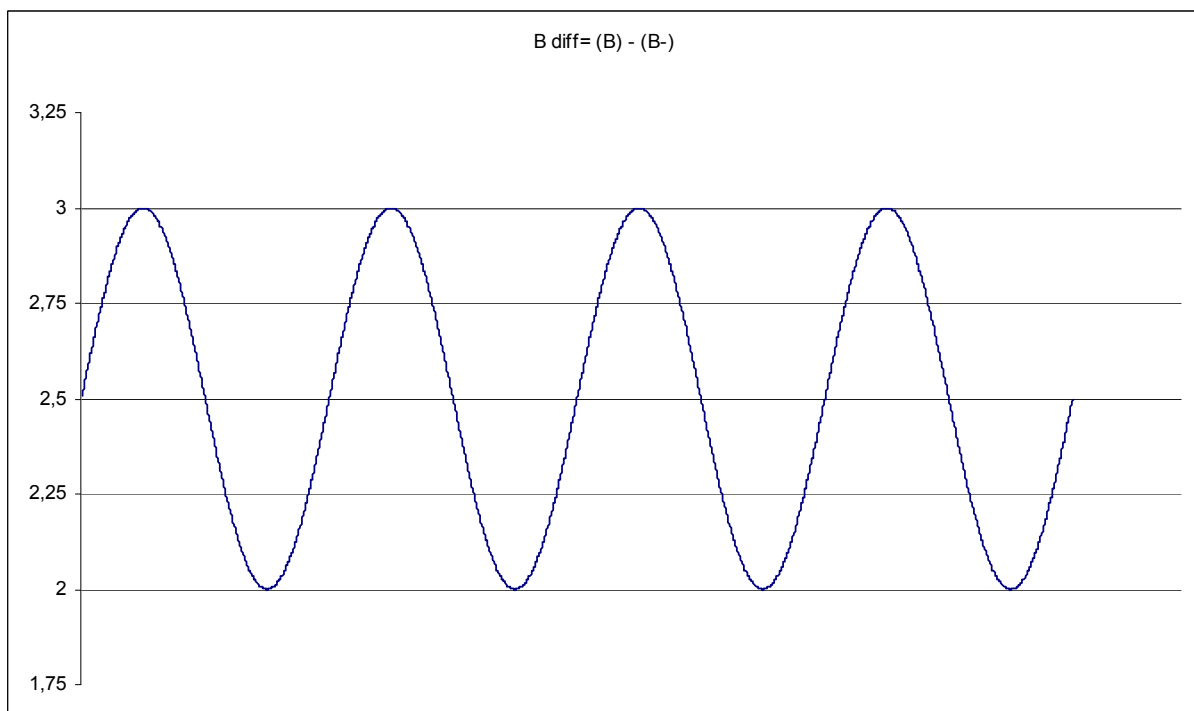
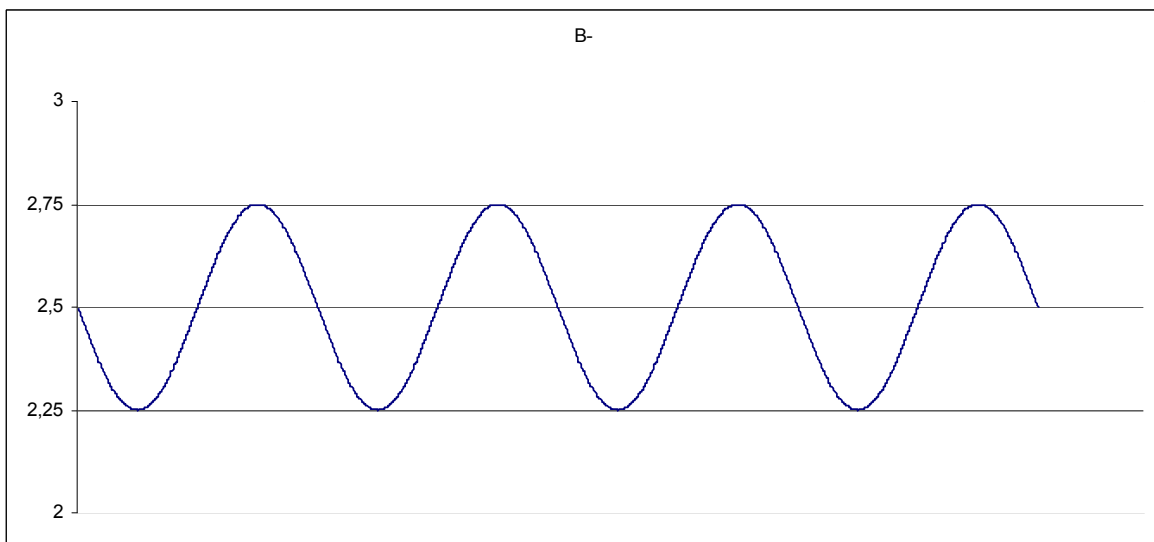
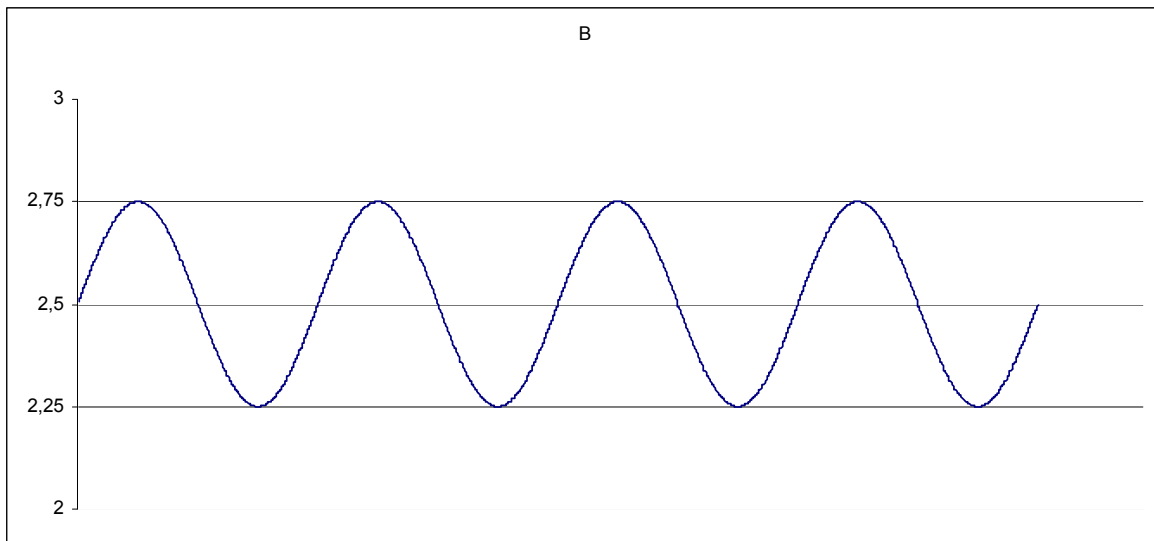

HSD

A signal temporal performance:

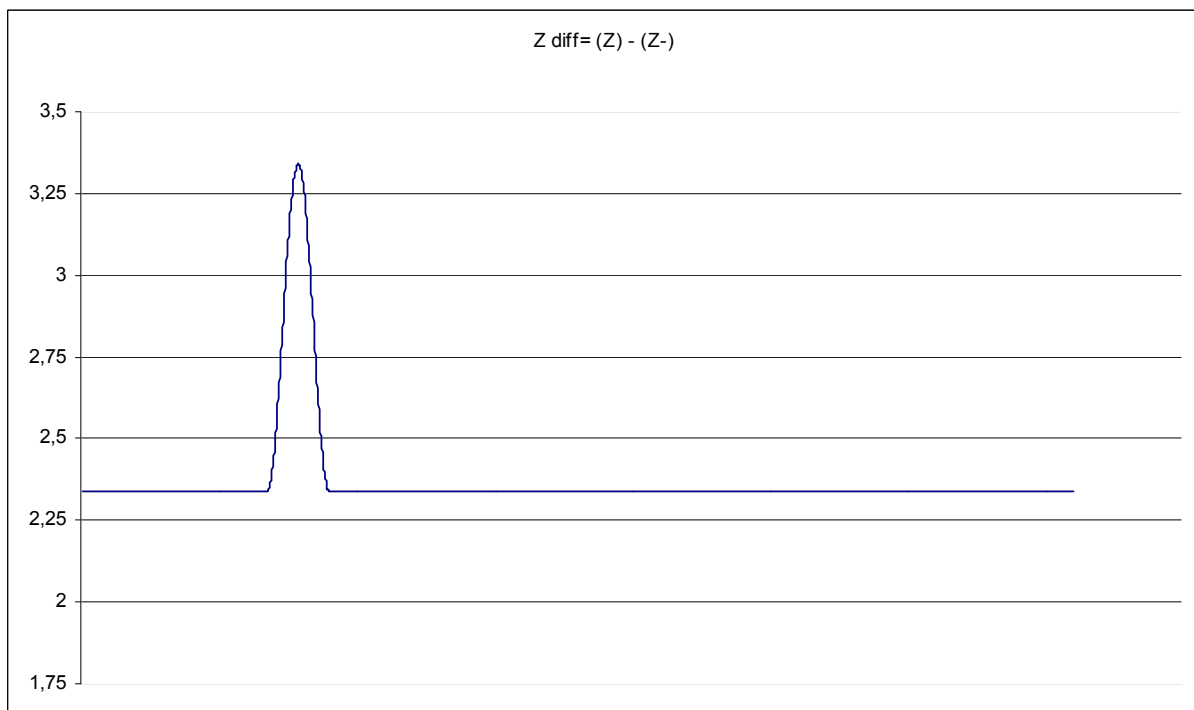
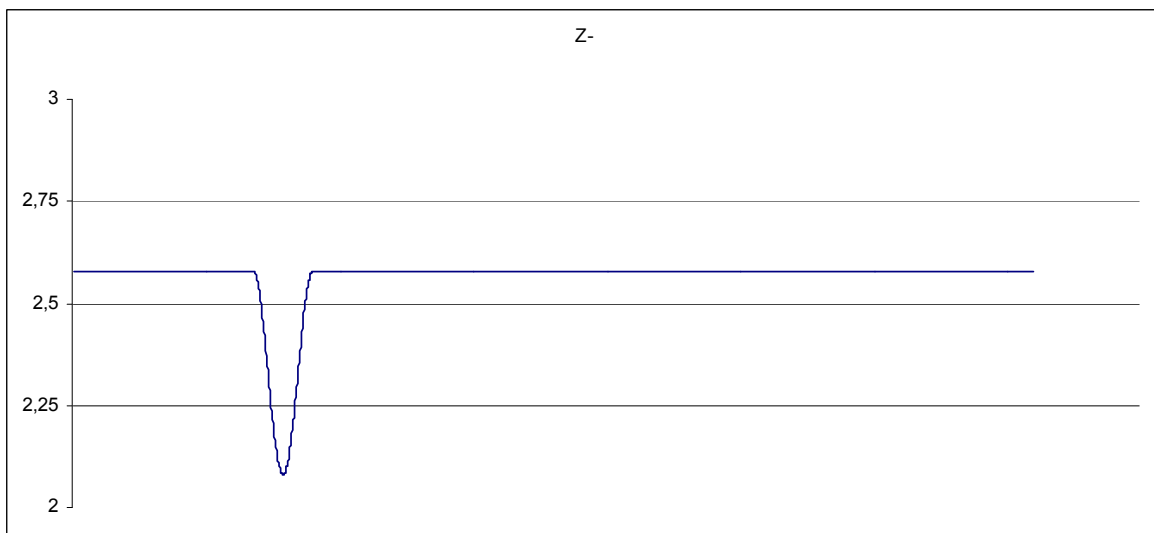
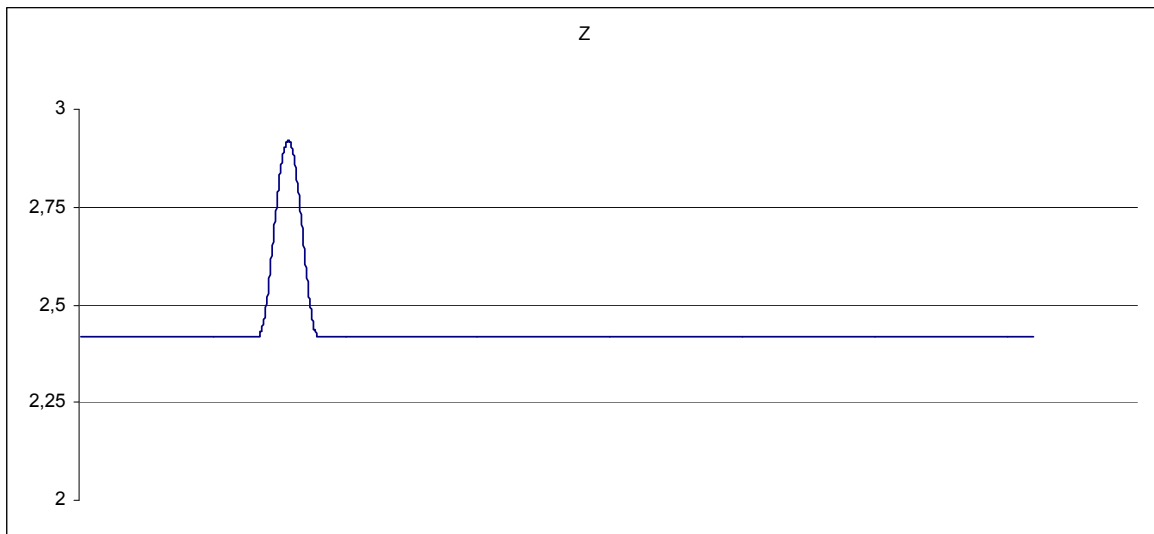

A and B signal phase difference

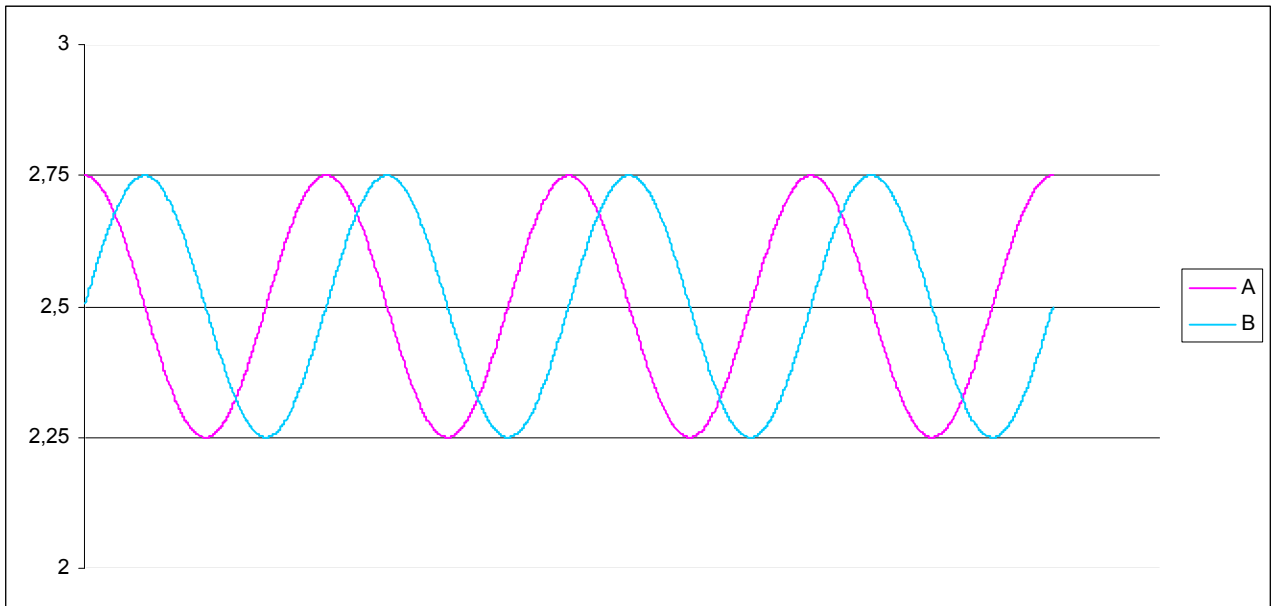

A and B negated signal phase difference

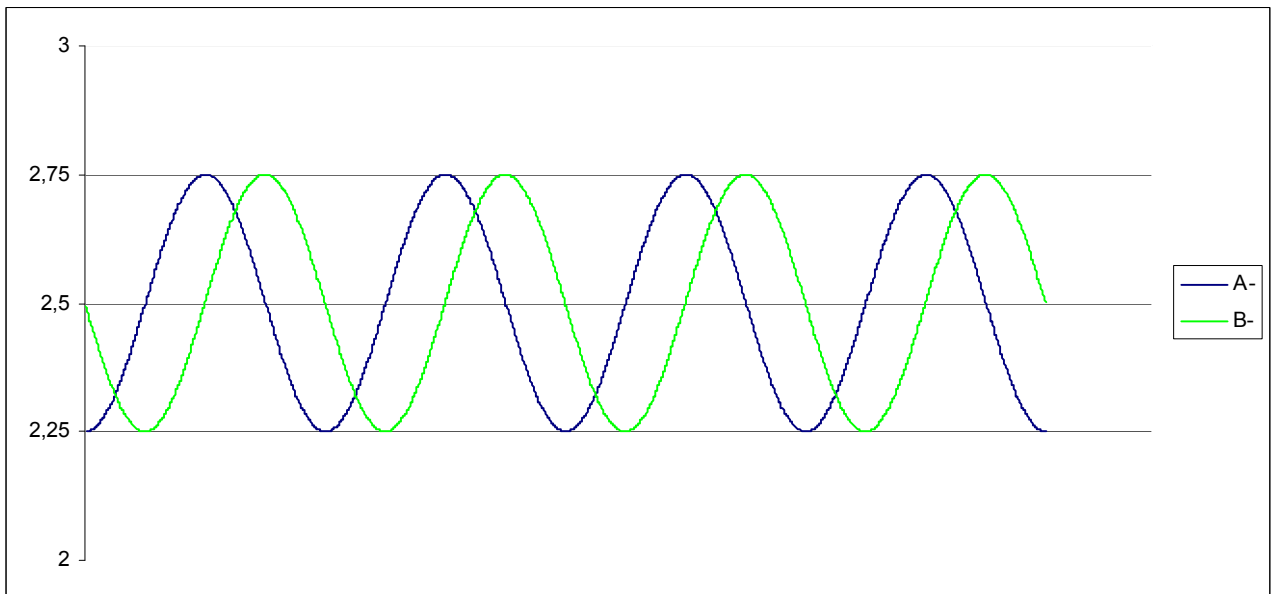

Differential signal temporal performance:

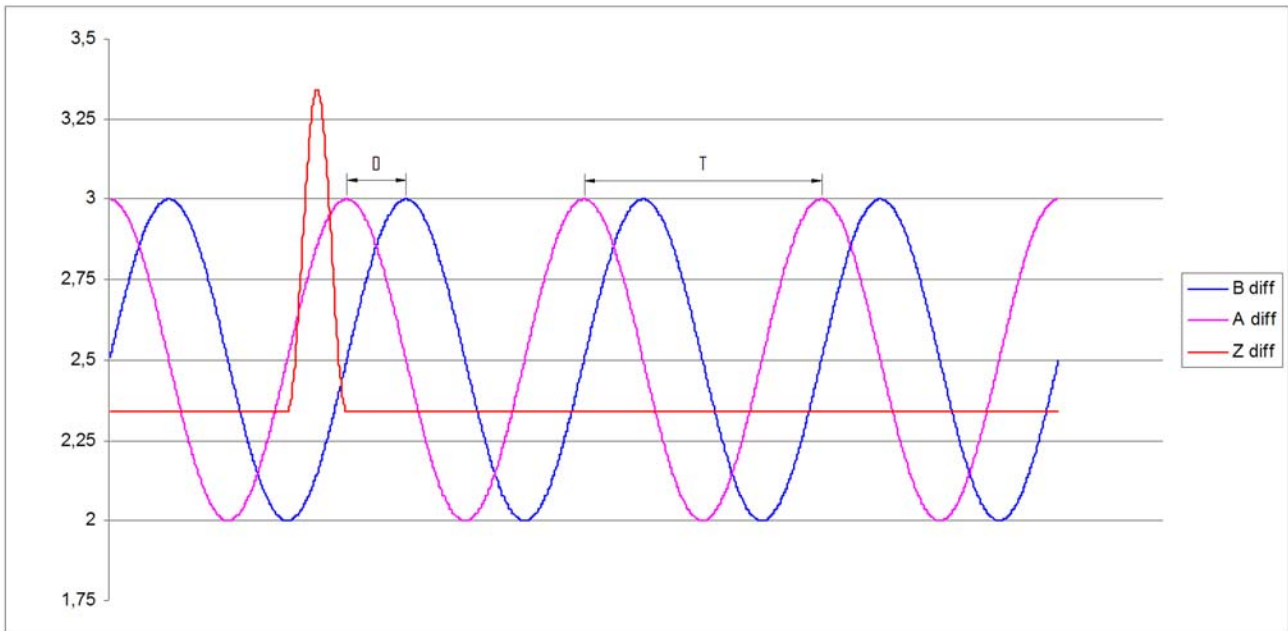

T	Period
D	Phase Difference ($D=T/4$)
A diff	(A) - (A-)
B diff	(B) - (B-)
Z diff	(Z) - (Z-)

Differential negated signal temporal performance:

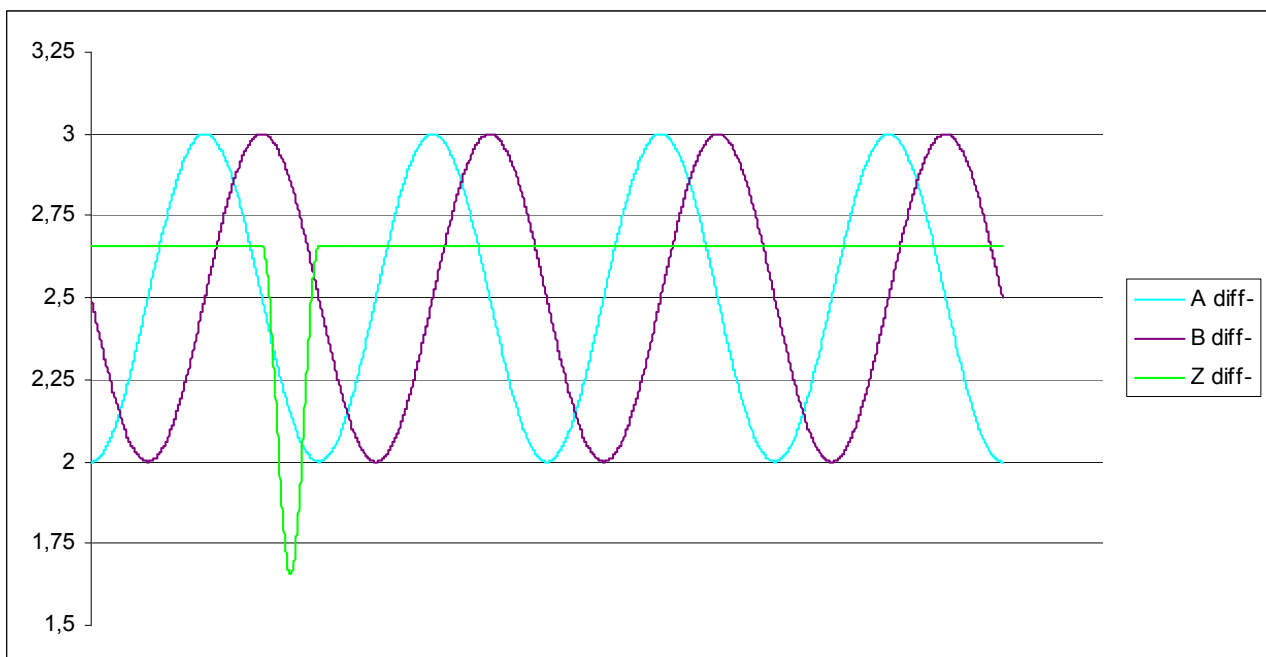

7 MAINTENANCE



To safely operate an electrospindle installed on the machine, refer to the manual of the machine itself.



Inside the electrospindle there is a pre-loaded spring with a force of several hundred kilograms. This spring is attached to a tie-rod that may fly out violently if the electrospindle is dismantled by personnel who have not been sufficiently trained.

Carry out only the operations described in this manual, paying close attention to the instructions given; if in doubt, contact the Assistance Service of HSD S.p.A.



Only the adjustment and replacement operations with original HSD S.p.A. spare parts described in this chapter are permitted.

Any other type of operation is not permitted and will invalidate the product guarantee.

Read this chapter carefully before carrying out maintenance operations on the electrospindle. The safety regulations during the maintenance of the electrospindle must take into account that:

- the maintenance operations must only be carried out by trained and qualified personnel, purposely authorised by the technical management of the plant, in accordance with the safety directives and standards in force, using tools, instruments and products suitable for this work;
- during the maintenance work it is obligatory to wear suitable clothing, such as close-fitting work overalls, safety shoes, strictly avoiding wide items or with protruding parts.

During any maintenance operations, the electrospindle must be:

- **disconnected and isolated from the electric power supply;**
- **compulsorily with the tool at a standstill (not in rotation).**

7.1 SCHEDULED MAINTENANCE



The punctual respect of the scheduled maintenance is essential in order to maintain the conditions of use and working planned by HSD S.p.A. when the product was put onto the market.



The frequency has been calculated on the basis of a working week of 5 days, each of 8 working hours, under normal ambient working conditions.

7.1.1 Checking the cleaning of the tool-holder cone and the conical housing in the spindle shaft

Frequency: DAILY

Before using the electrospindle, ensure that the conical surfaces of the tool-holders (highlighted in black in Figure7 1. and Figure7 2.) and the conical surface of the tool-holder housing in the spindle shaft (highlighted in black in Figure7 3. and Figure7 4.) are thoroughly clean, with no traces of dust, grease, cooling liquid, oil or metallic particles, nor traces of oxide or scale;

ONLY FOR THE HSK MODEL: make the same check also on the stop surfaces of both the tool-holder and the spindle (surfaces highlighted in grey and indicated by no.2 in Figure7 2.) and Figure7 4.).

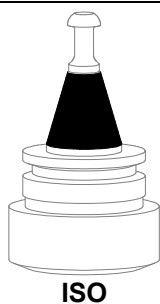

Figure7 1. Conical surface of the ISO tool-holder (highlighted in black)

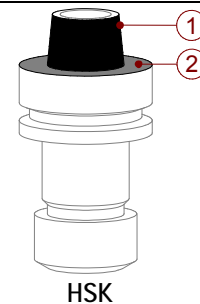

Figure7 2. HSK tool-holder:
(1) Conical surface (highlighted in black)
(2) Stop surface (highlighted in grey)

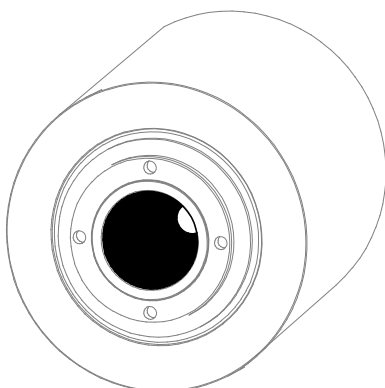

Figure7 3. Conical surface of the ISO spindle shaft (highlighted in black)

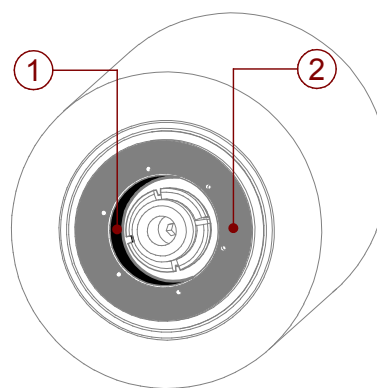
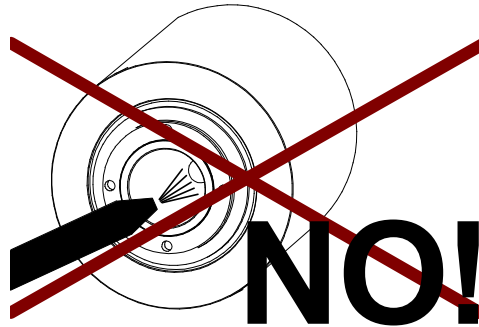

Figure7 4. HSK tool-holder housing
(1) Conical surface (in black)
(2) Stop surface (in grey)

Daily cleaning is recommended, at the end of the working day, using a clean, soft cloth.



DO NOT DIRECT JETS OF COMPRESSED AIR INTO THE SPINDLE SHAFT WHEN THE TOOL-HOLDER CONE IS ABSENT (figure below).



Never point jets into the pressurised seal labyrinth area, as the infiltrations damage the inside of the electrospindle.

Do not point jets inside the electrospindle when the tool-holder is not attached, as the coupling surface with the tool-holder may get dirty or machining operation waste may enter the electrospindle.

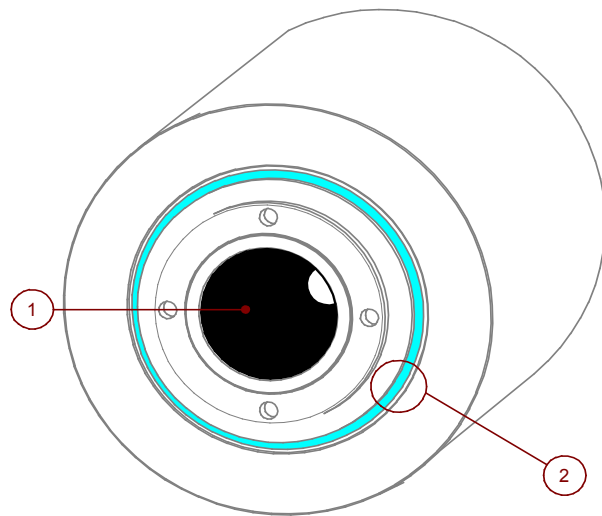

1	Coupling surface.
2	Labyrinth seal.



IMPERFECT CLEANING PREVENTS THE CORRECT POSITIONING OF THE TOOL-HOLDER, WITH SERIOUS CONSEQUENCES FOR THE SAFETY OF THE OPERATOR, THE WEAR AND TEAR OF THE ELECTROSPINDLE AND TOOL-HOLDER, THE PRECISION AND EFFICIENCY OF THE MACHINING OPERATION.



TO CLEAN THE SURFACES HIGHLIGHTED FROM Figure7 1. TO Figure7 4., USE CLEAN, SOFT CLOTHS; NEVER USE ABRASIVE INSTRUMENTS SUCH AS WIRE WOOL, METAL SCRAPERS, EMERY CLOTH, ACIDS OR OTHER AGGRESSIVE MEDIA.

7.1.2 Purging the filters of the pneumatic circuit

Frequency: DAILY

At the end of the work shift, discharge the compressed air circuit to allow the automatic purging of the filters that protect the HSD product (see section 4.4)

7.1.3 Protecting the conical seat in the spindle shaft

Frequency: DAILY



THE SEAT OF THE TOOL-HOLDER CONE IN THE SPINDLE SHAFT MUST ALWAYS BE PROTECTED FROM IMPURITIES: USE A CLOSING DEVICE OR A TOOL-HOLDER CONE.



AT THE END OF THE MACHINING OPERATIONS, ALWAYS REMOVE THE TOOL-HOLDER CONE FROM THE ELECTROSPINDLE, TO AVOID ANY PROBLEM OF IT STICKING. REPLACE IT WITH A CLEAN TOOL-HOLDER CONE AT ROOM TEMPERATURE, TO PROTECT THE INSIDE OF THE ELECTROSPINDLE FROM THE OUTSIDE ENVIRONMENT.

7.1.4 Cleaning the tool-holder cone

Frequency: EVERY TWO WEEKS

Carefully clean the conical surfaces of the tool-holders (highlighted in black in Figure 7.1 and Figure 7.2.) with a clean soft cloth impregnated with ethyl alcohol.

ONLY FOR HSK MODELS: after cleaning with ethyl alcohol, spray the conical surface with **KLÜBER LUSIN PROTECT G 31**, and distribute the product uniformly using a clean, dry cloth. Allow the product to dry before using the tool-holder again.

7.1.5 Lubricating the HSK collet

Frequency: MONTHLY

In order to maintain the proper efficiency of the HSK collet over a long period of time, it must be lubricated every month with grease:

METAFLUX-Fett-Paste no.70-8508

or, alternatively

METAFLUX-Moly-Spray no.70.82

depositing the grease between the segments and the expeller of the HSK collet (see Figure 7.5).

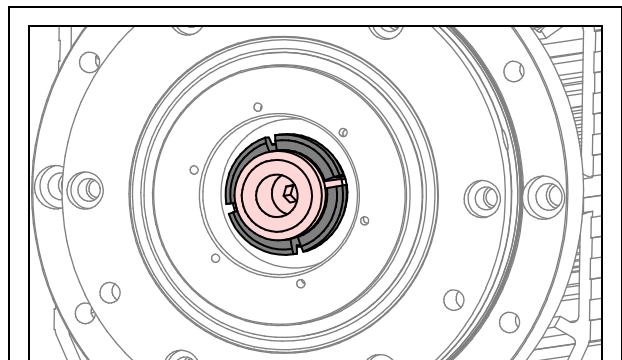

Figure 7.5 Segments (grey) and expeller (pink) of the HSK hook-up system

EXCESSES OF GREASE ARE HARMFUL.

After applying the above-mentioned grease as described, make some tool changes in order to distribute it evenly.

Finally, remove the tool holder from the spindle shaft and, with a clean cloth, remove any visible lumps of grease as they could hold wood chips or other machining operation residues, dirtying the collet, the conical surfaces and the stop surfaces. These areas must be kept as clean as possible in order to guarantee the safety of the operator, the precision of the machining operation, and to reduce wear on the spindle and tool-holder cone.



USE ONLY THE GREASES INDICATED ABOVE.

OTHER PRODUCTS ARE INCOMPATIBLE WITH THAT USED BY HSD FOR THE FIRST GREASING.

GREASES THAT ARE INCOMPATIBLE, MIXED OR USED SUCCESSIVELY ON THE SAME COLLET FORM SUBSTANCES HARMFUL TO THE FUNCTIONING OF THE COLLET ITSELF, WITH SERIOUS CONSEQUENCES FOR SAFETY.

7.1.6 Check of functionality collet HSK

Frequency : 6 MONTHS or 200000 tool changes

- Control the expulsion limit (see limit “ B1” in table 8.1, pag 168)
- Through a blocked tool tighten the dowel in the expeller
- Check the tightening strength (using Power Check). If the tightening force is inferior of 70 % of the nominal value, it is necessary to effect the following operations:
 - grease again , and check again the tightening force
 - change the collet and check again
 - change completey the thightening device

7.1.7 Checking the connections

Frequency: MONTHLY

Check the integrity of the electrical cables of both power and signals, and also that the connectors are firmly fixed. Check the seal of the tubes and connectors of the cooling and compressed air circuits.

7.1.8 Replacing the filters of the pneumatic circuit

Frequency: ACCORDING TO THE MANUFACTURER'S INSTRUCTIONS

Carry out regular maintenance and replacement of the filters of the pneumatic circuit for the HSD product, following the manufacturer's indications (see section 4.4)

7.1.9 Bearings

Frequency: NEVER



THE BEARINGS HAVE BEEN LUBRICATED FOR LIFE AND DO NOT REQUIRE RECURRENT ADDITIONS OF GREASE.

8 REPLACING COMPONENTS

8.1 REPLACING THE ELECTRIC FAN

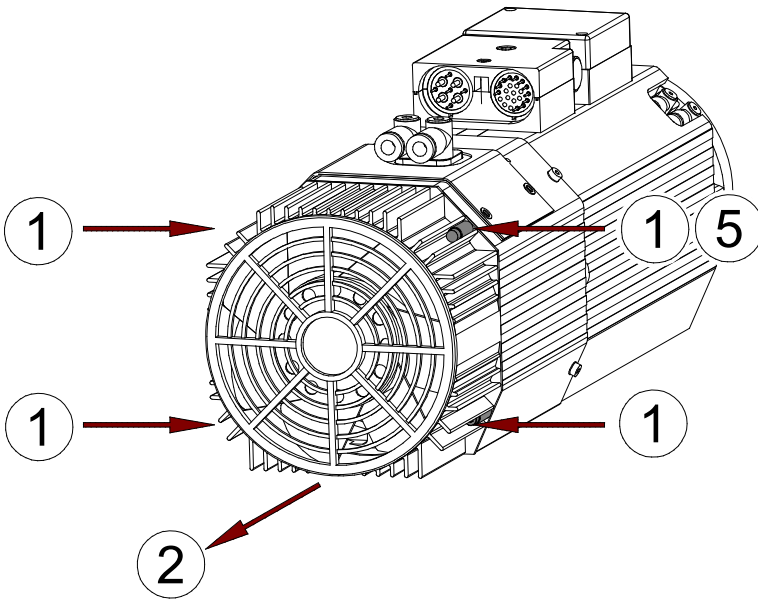



1	Remove the four fixing screws of the electric fan unit.
2	Move the electric fan unit in an axial direction.
3	Disconnect the electrical connector of the electric fan.
4	Connect the electrical connector of the new electric fan.
5	Insert the earth cable of the new electric fan in the appropriate space (5), so that it is blocked by the screw in the next point (6).
6	Fix the new electric fan with the four screws, paying attention to the earth connection.

8.2 REPLACING THE SHAFT KIT FOR MODELS ES884, ES888

8.2.1 Disassembly procedure

<p>1. Cut the heat-shrinking sheath and disconnect the sensor connectors</p>	
<p>2. Remove the ten screws that block the cover of the mounting plate bracket</p>	

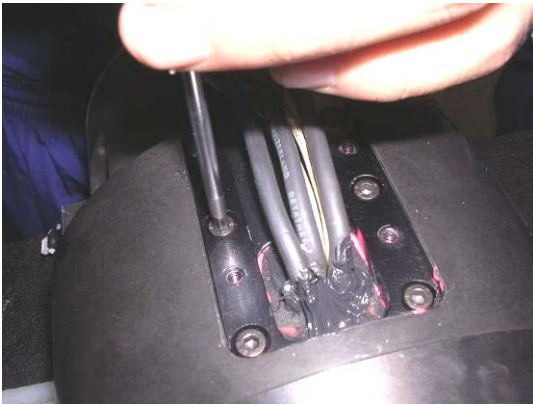

HSD



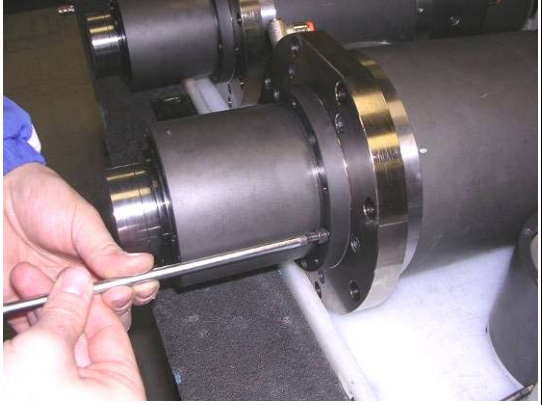

<p>3. Remove the cover of the mounting plate bracket</p>	
<p>4. Release the bracket, removing the six screws that fix it to the statoric unit</p>	
<p>5. Loosen the six 6x105 screws from the cylinder</p>	
<p>6. The cylinder is fixed with "Loctite 510" sealing paste, for an easier disconnection: - hold the cylinder unit firmly - feed it with max. 2 bar.</p>	
<p>7. Loosen the eight 6x14 screws from the two semi-rings</p>	

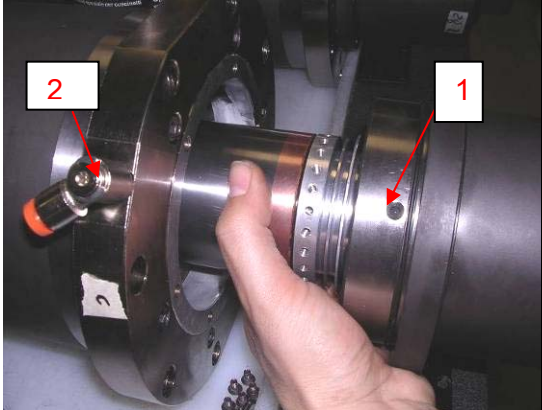
HSD



<p>8. Loosen the eight 6x20 screws from the front flange</p>	
<p>9. Carefully unthread the shaft kit</p>	

8.2.2 Assembly procedure

<p>1. Insert the shaft kit, taking care to align the pressurisation holes on the kit (on the outer side surface 1) and on the statoric unit (inner side surface 2)</p>	
<p>2. Tighten the eight 6x20 screws (with knurled washer) on the front flange, and definitively tighten with a torque wrench at 14Nm</p>	
<p>3. Tighten the eight 6x14 screws (with knurled washer) on the semi-rings, using a torque of 10 Nm</p>	
<p>4. Spread a layer of Loctite 510 (573) on the reaction flange</p>	

<p>5. Reassemble the cylinder unit, tightening the six 6x105 screws (with copper washer and applying Loctite 222 on the thread), then definitively tighten using a torque of 14Nm</p>	
<p>6. Spread a layer of Loctite 510 inside the seat of the mounting plate bracket</p>	
<p>7. Block the bracket with the six screws</p>	
<p>8. Spread a layer of Loctite 510 on the mounting plate bracket</p>	



HSD

<p>9. Reassemble the cover, tightening the ten screws used previously</p>	
<p>10. Connect the sensor connectors and recover them with the heat-shrinking sheath</p>	
<p>11. Carry out the sensor calibration procedure</p>	

8.3 REPLACING THE SHAFT KIT FOR MODELS ES915,ES919,ES929,ES988

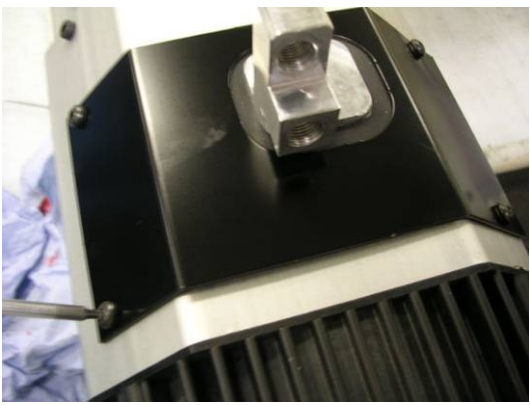
8.3.1 Disassembly procedure

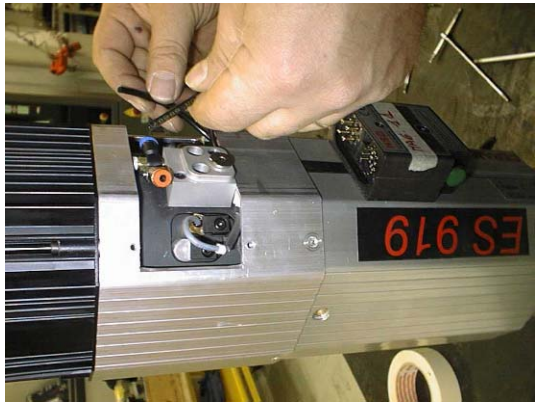
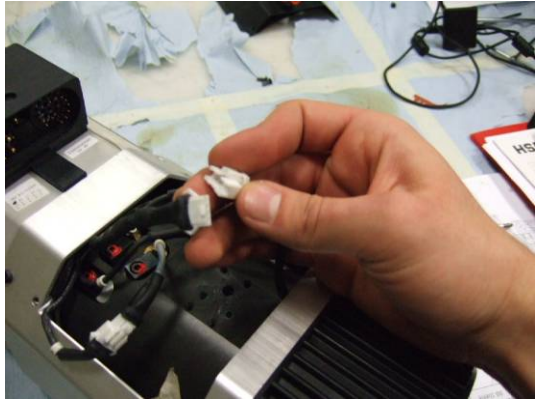
<p>1. Remove the two pneumatic connectors</p>	
<p>2. Remove the steel sheet cover by loosening the four fixing screws</p>	

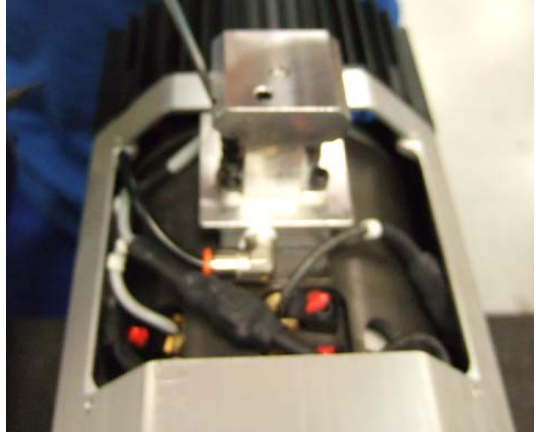
<p>3. Disconnect all the pneumatic connections and the relative sensors</p>	
<p>4. Open all the internal movable connections (inductive sensors and electric fan)</p>	
<p>Loosen the two screws indicated in the figure and remove the pressurisation block</p>	
<p>5.</p> <p>Variation ES939: loosen the four screws indicated in the figure and remove the pneumatic block</p>	

6. Take out the screws and completely remove the electric fan support

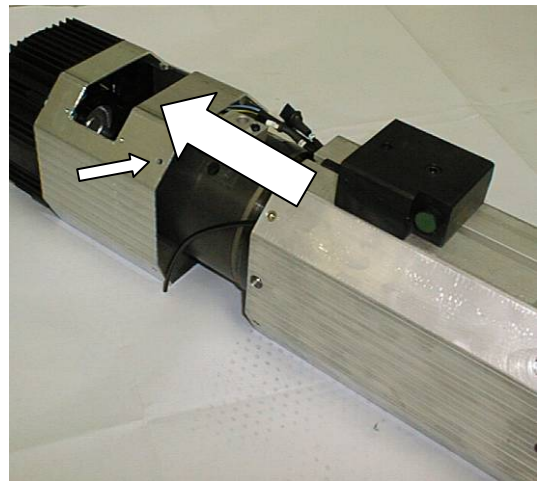

7. Remove the six screws fixing the release cylinder unit as indicated in the figure

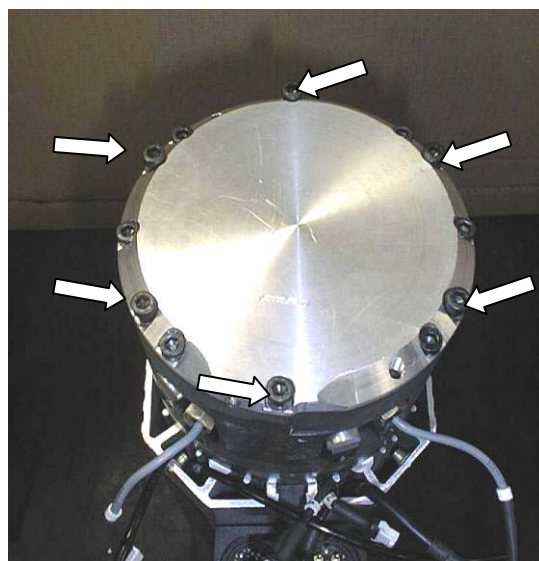

8. Remove the release cylinder unit by raising it in the direction of the axis



9.

Rear view of the electrospindle. In the foreground, the reaction system with the eight fixing screws

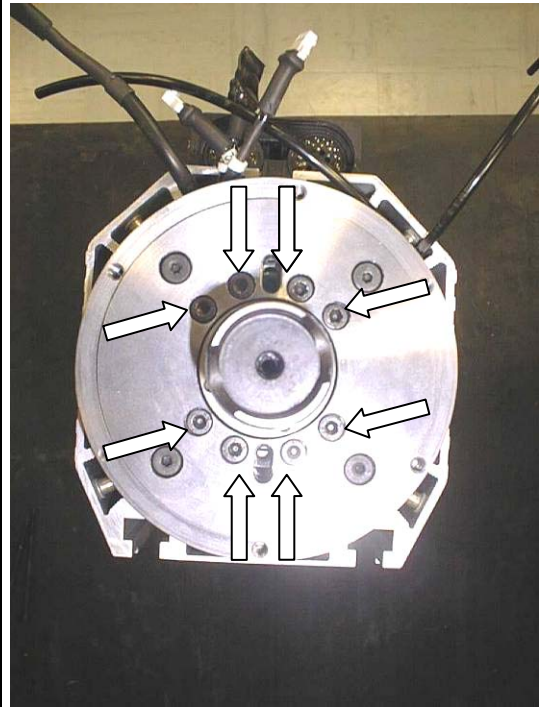

10.

Partly tighten the two long screws (TCEI M5x90 UNI 5931) as shown in the figure

Variation ES939: operation not necessary

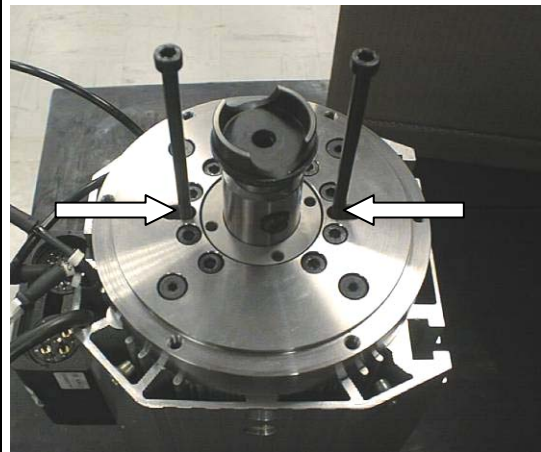



11.

Remove the eight fixing screws from the reaction system

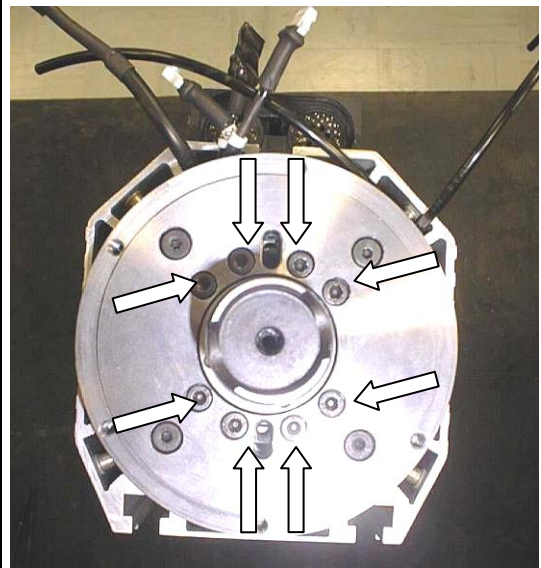
Variation ES939: on models ES939 the semi-rings can be removed; loosen the eight screws and remove the semi-rings

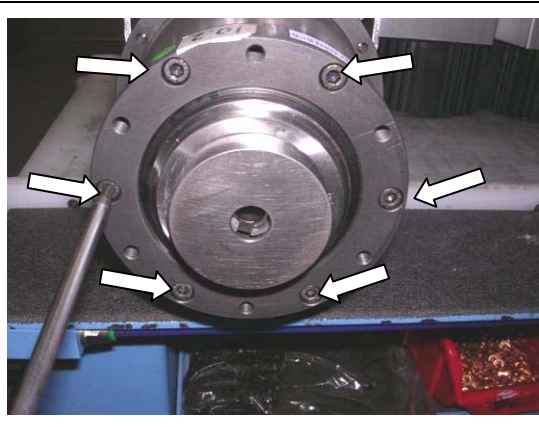

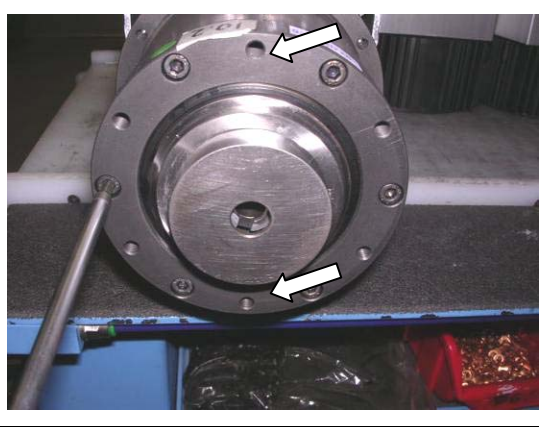
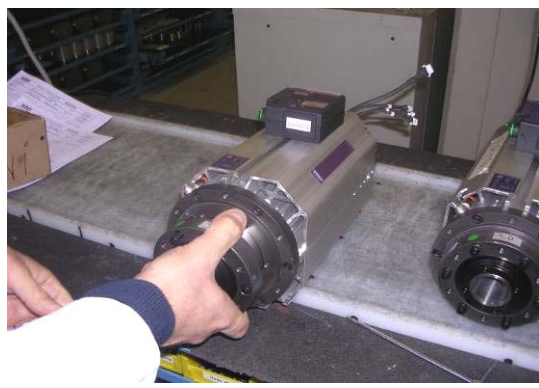
<p>12. Remove the six fixing screws of the shaft</p>	 A close-up photograph of a cylindrical metal shaft unit. Six screws are visible around the perimeter of the unit's flange. White arrows point to each of these screws. A screwdriver is shown in the process of removing one of the screws on the left side.
<p>13. Simultaneously with operations 14 and 15 below, open the reaction system, working in a radial direction as shown in the figure</p> <p>Variation ES939: operation not necessary</p>	 A photograph showing a person's hands using two long, thin metal tools to pry open a component of the reaction system. The component is a cylindrical metal housing. White arrows point outwards from the center of the housing, indicating the radial direction of the opening.
<p>14. Use a fixing screw of the shaft unit to facilitate its extraction from the spindle sleeve, tightening it in one of the bores.</p> <p>Do not use any bores not shown in the figure alongside.</p>	 A close-up photograph of the shaft unit being worked on. A screw is being tightened into one of the bores on the flange. White arrows point to the specific bore being used and the screw being inserted.
<p>15. Carefully extract the shaft unit from its seat in the sleeve</p>	 A photograph showing a person's hand pulling the shaft unit out of its sleeve. The shaft unit is being held by the hand and is being moved away from the sleeve. The sleeve is a larger, cylindrical metal component.

8.3.2 Assembly procedure

Assemble the shaft kit, taking care to align the pressurisation air passage bore of the shaft with the corresponding one on the flange.

The misalignment of these two bores can notably prejudice the correct working of the electrospindle, and cause the seizure of the bearings.

Check the presence of the OR on the pressurisation bore in the framework (OR 2018 for short nose versions, and OR 106 for long nose versions). If the OR seems worn, replace it.

1.

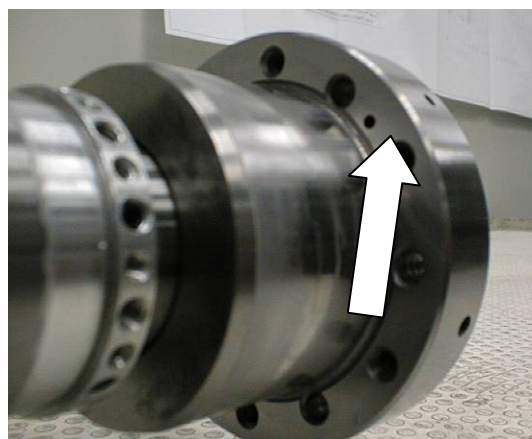
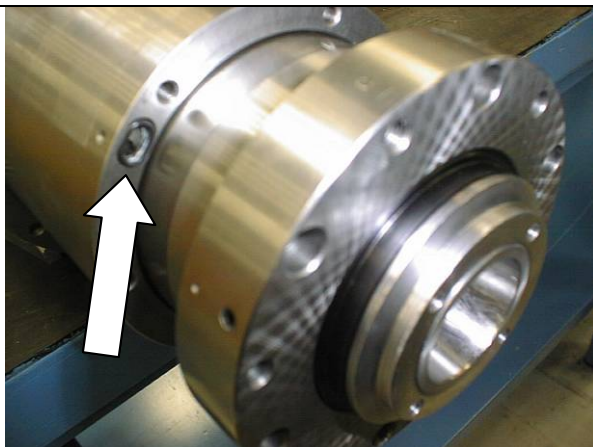

2.



3.

Carefully insert the new shaft unit in the spindle sleeve after reopening the reaction system, as indicated in 13, pushing everything onto the stop

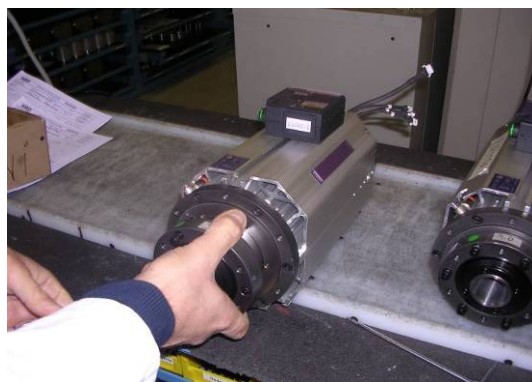

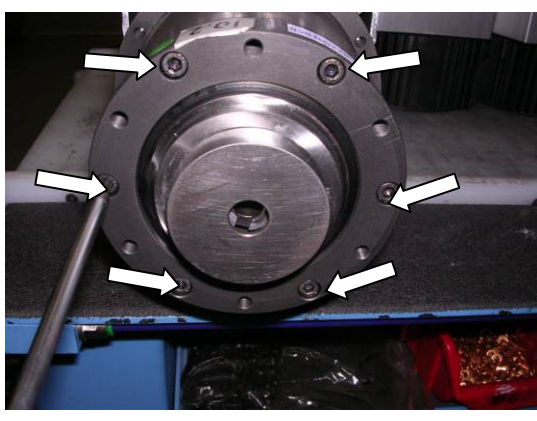
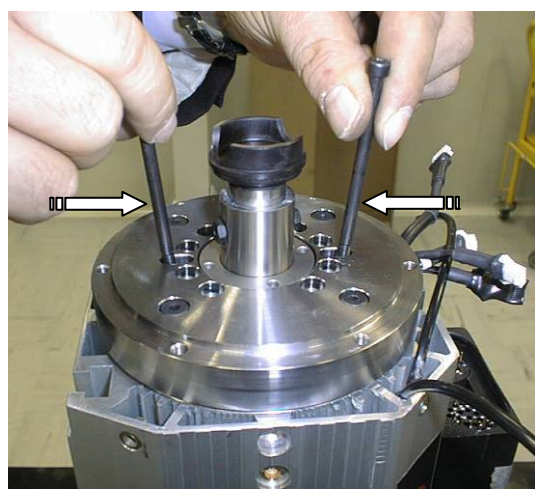
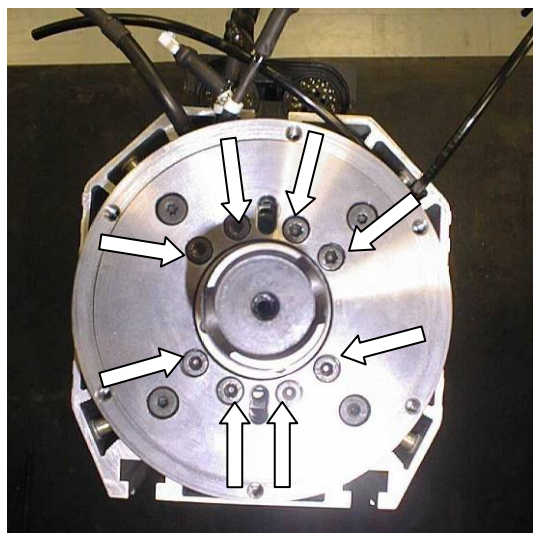
<p>4. Block the shaft unit, using the six fixing screws (with a tightening torque of 12 Nm with cross-tightening)</p>	 A close-up photograph of a cylindrical metal shaft unit. Six screws are being used to secure it, with white arrows pointing to each screw. The unit is mounted on a blue metal frame.
<p>5. Close the reaction system, working in a radial direction as shown in the figure</p> <p>Variation ES939: operation not necessary</p>	 A photograph showing a person's hands using two screws to close a reaction system. The screws are being inserted into a central hub. White arrows indicate the radial direction of the screws.
<p>6. Block the reaction system, using the eight fixing screws. Remove the two M5x90 service screws</p> <p>Variation ES939: Reassemble the semi-rings as at the beginning, blocking them with the eight fixing screws</p>	 A photograph of the reaction system assembly. Eight screws are used to block it, with white arrows pointing to each screw. Two larger screws are also visible at the bottom.

7. Carefully insert the cylinder unit



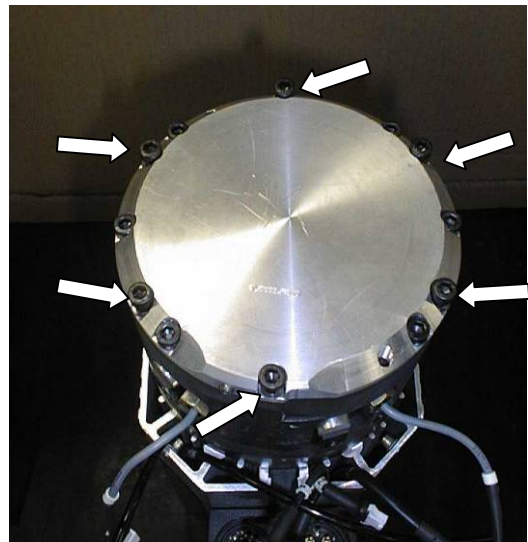

8. Block the cylinder unit, using the six fixing screws (with a tightening torque of 7 Nm with cross-tightening)
919:5x100

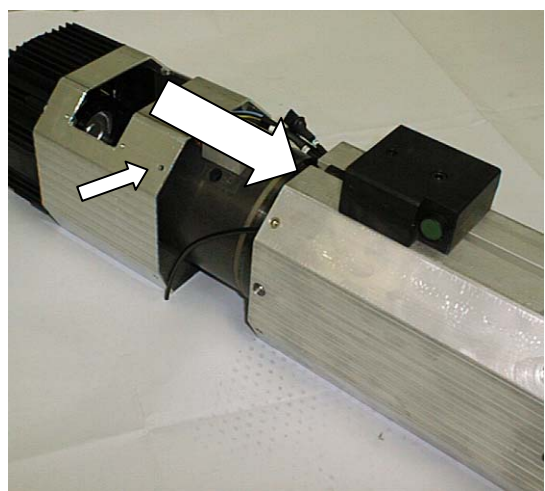

9. Reinsert the casing of the electric fan, and tighten the four screws on the sides of the casing, as shown in the figure

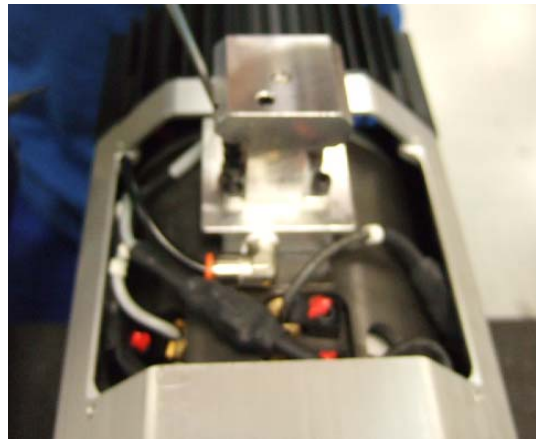

<p>Tighten the pressurisation block as shown in the figure.</p>	
<p>10.</p> <p>Variation ES939: reassemble the pneumatic block, tightening the four screws indicated in the figure.</p>	
<p>11. Apply the two pneumatic connectors.</p>	
<p>12. Close the internal movable connections (inductive sensors and electric fan) and insert the rubber pressurisation tubes in the special connector on the pneumatic connections block</p>	
<p>13. Carry out the sensor calibration procedure.</p>	

HSD

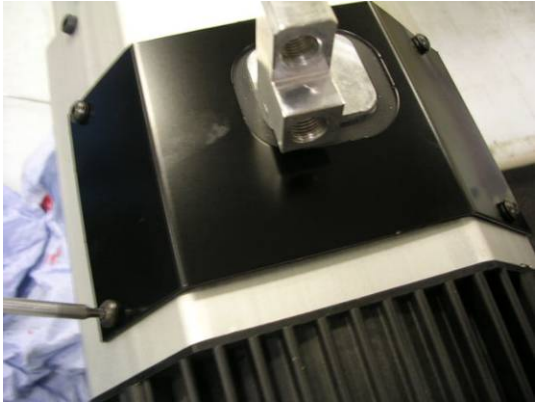

<p>14. Apply the gasket and the steel sheet cover</p>	
<p>15. Fix the cover using the four screws</p>	

8.4 REPLACING THE SHAFT KIT FOR MODELS ES919 ENCODER

8.4.1 Disassembly procedure

<p>1. Follow steps 1 to 13 of the disassembly procedure for the standard models</p>	
<p>2. Loosen the four 4x25 screws of the encoder box</p>	

HSD

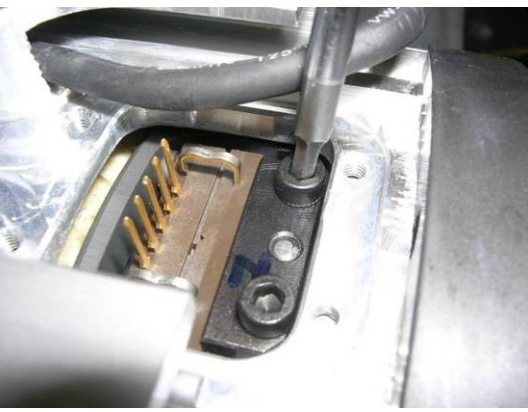
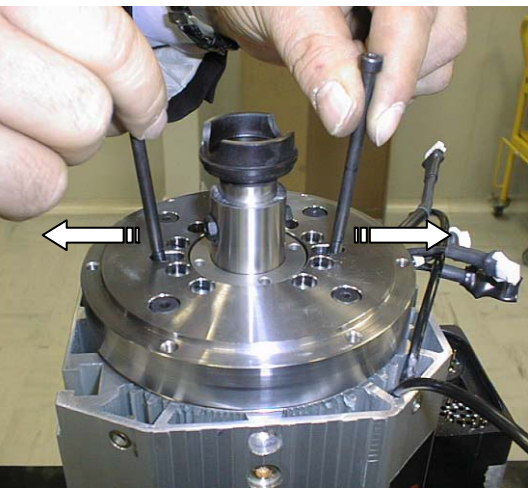
<p>3. Loosen the four 4x10 screws of the encoder cable manifold</p>	
<p>4. Detach the encoder connector</p>	
<p>5. Loosen the two 3x8 screws of the encoder reader bracket. Disassemble the encoder reader-bracket assembly.</p>	
<p>6. Open the reaction system, working in a radial direction as shown in the figure</p>	

7.

Use a fixing screw of the shaft unit to facilitate its extraction from the spindle sleeve, tightening it in one of the bores.
Do not use any bores not shown in the figure alongside.

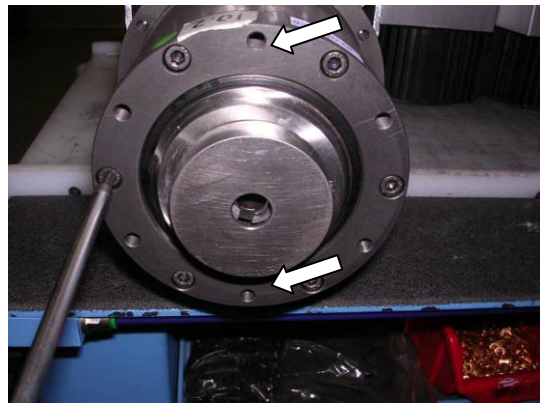



8.

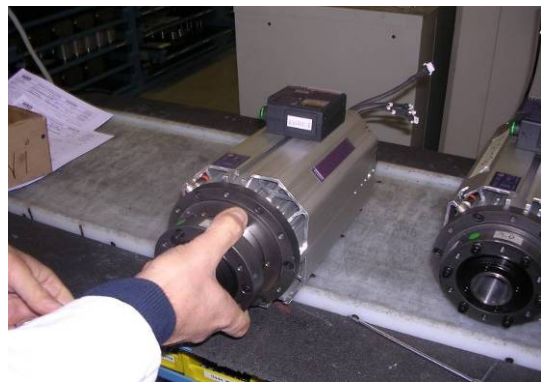

Carefully extract the shaft unit from its seat in the sleeve

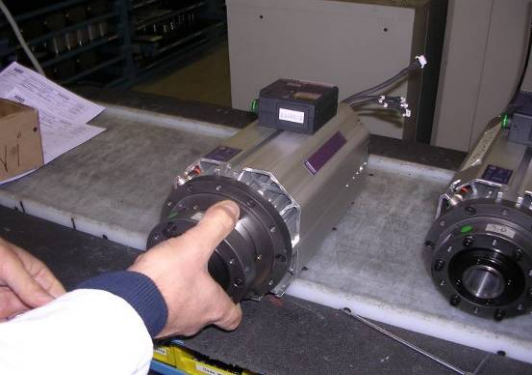
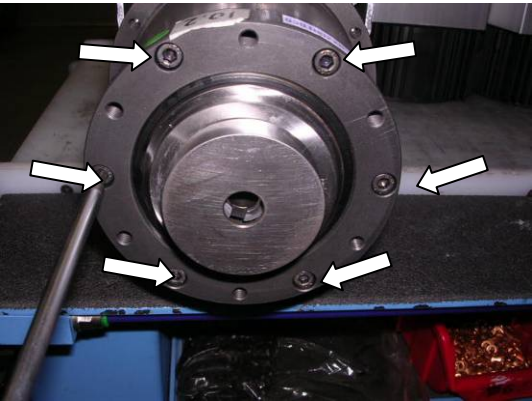

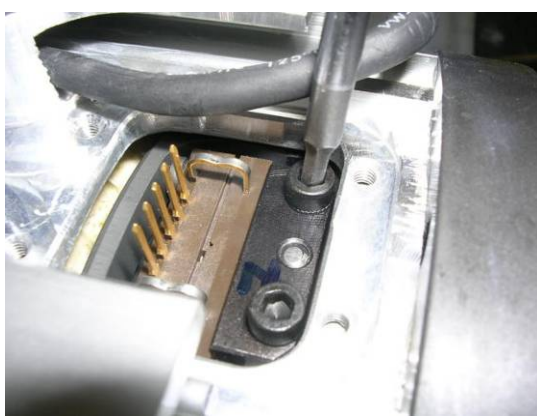
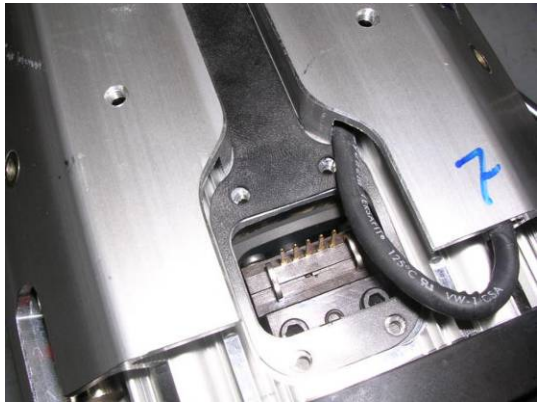

8.4.2 Assembly procedure

<p>1. Assemble the shaft kit, taking care to align the pressurisation air passage bore of the shaft with the corresponding one on the flange. In this way, the slot for inserting the encoder reader will be facing upwards.</p> <p>The misalignment of these two bores can notably prejudice the correct working of the electrospindle, and cause the seizure of the bearings.</p>	
<p>2. Carefully insert the new shaft unit in the spindle sleeve after reopening the reaction system, as indicated in 1, pushing everything onto the stop</p>	
<p>3. Block the shaft unit, using the six fixing screws (TCEI 6x20 12.9) with a tightening torque of 14 Nm with cross-tightening.</p>	
<p>4. Assemble the bracket/encoder reader assembly.</p>	

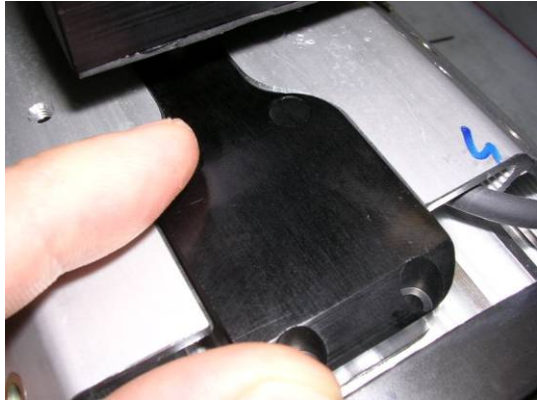



HSD

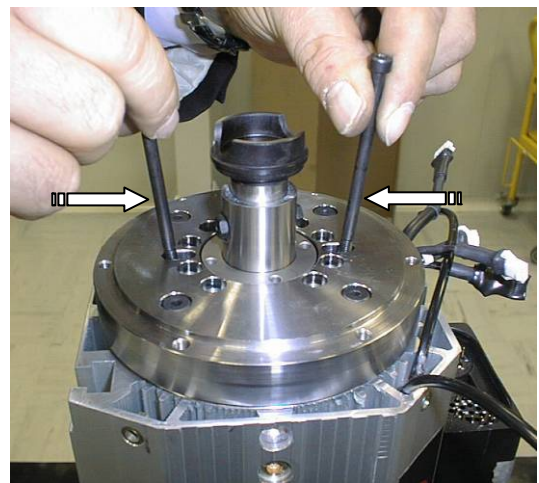

<p>5. Block with two 3x8 screws + a knurled washer.</p>	 A close-up photograph showing a metal manifold being secured to a larger metal block. A screw is being inserted through the manifold into the block, with a knurled washer placed between them. The manifold has several gold-colored pins protruding from its top surface.
<p>6. Insert the manifold gasket</p>	 A close-up photograph showing a black manifold gasket being inserted into a cavity in a metal manifold. The gasket is being pushed into place by a hand. A blue number '7' is visible on the metal surface next to the gasket.
<p>7. Connect the connector to the encoder reader, ensuring that the black wire is on the right.</p>	 A close-up photograph showing a white connector being connected to an encoder reader. The connector has several colored wires (white, green, yellow, red, black) protruding from it. The encoder reader has a corresponding socket with gold pins. A blue number '7' is visible on the metal surface next to the connector.
<p>8. Insert the encoder cable manifold in the appropriate cavity.</p>	 A close-up photograph showing a black encoder cable manifold being inserted into a cavity in a metal manifold. A hand is holding the manifold and pushing it into the cavity. A blue number '5' is visible on the metal surface next to the manifold.

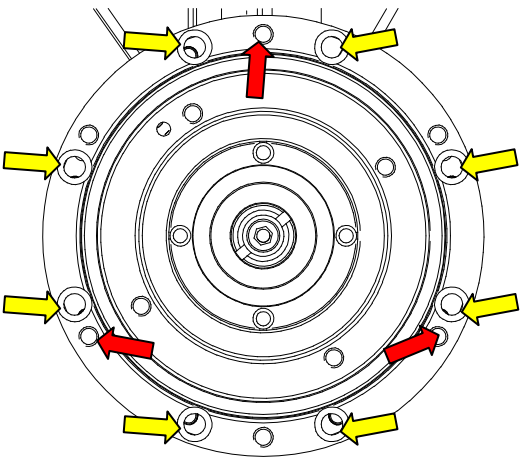
HSD

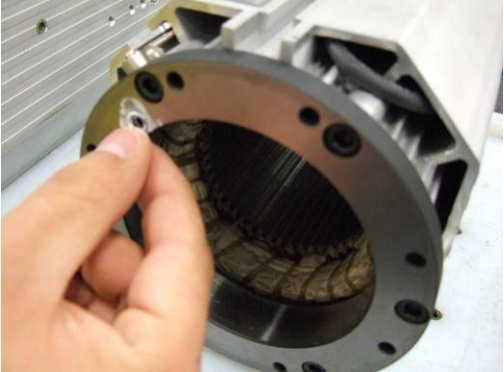
<p>9. Block the encoder electrical box with four 4x25 lowered head screws, using Loctite 510 and a copper washer.</p>	
<p>10. Block the encoder cable manifold with four 3x10 screws + a knurled washer.</p>	
<p>11. Close the reaction system, working in a radial direction as shown in the figure</p>	
<p>12. Follow steps 21 to 28 of the disassembly procedure for the standard models, until the assembly is complete</p>	
<p>13. Carry out the sensor calibration procedure.</p>	

8.5 REPLACING THE SHAFT KIT FOR MODELS ES939

<p>Loosen the eight M5x20 screws on the front flange.</p> <p>To extract the shaft kit, insert two M6x30 (or longer) flat bit lockscrews in the extraction bores of the front flange (indicated by the red arrows).</p> <p>1.  INFORMATION: In the first production batch, the flange was sealed with Loctite 510 and there are no extraction bores: the extraction operation may therefore be difficult. In this case, contact HSD.</p>	
<p>2. Unthread the old shaft kit and insert the new one, taking care to align the two pressurisation air passage bores on the front flange and on the framework.</p>	
<p>3. Position the OR 2018 on the front flange, after spreading a layer of assembly paste such as Altemp NB50 on the OR.</p>	
<p>4. Spread a layer of Altemp grease on the shaft kit in the seat of the OR.</p>	

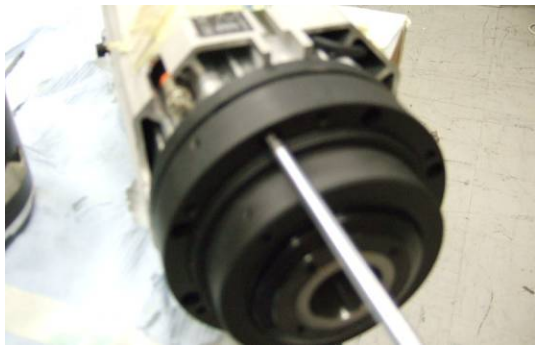
<p>5. Assemble the OR 3350, after greasing it with the same grease indicated above.</p>	
<p>6. Insert the shaft kit, taking care to align the pressurisation air passage bores on the front flange and on the framework.</p>	
<p>7. Tighten the M5x20 screws (of a material with a resistance class of 12.9) on the front flange, using a tightening torque of 10 Nm</p>	
<p>8. Carry out the sensor calibration procedure.</p>	

8.6 REPLACING THE SHAFT KIT FOR MODELS ES939 WITH ENCODER

8.6.1 Cylinder unit disassembly

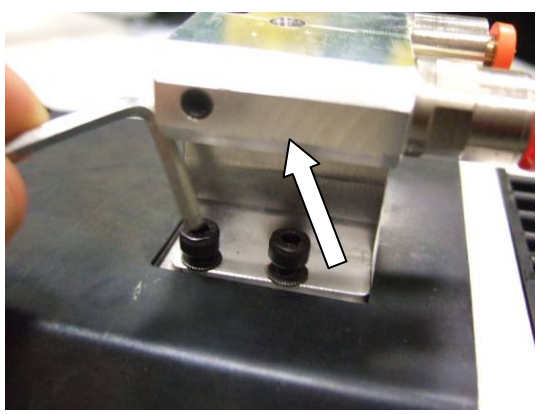
<p>1. Disassemble the pneumatic connections block by loosening the four M4 screws from the block with an L-shaped Allen spanner.</p>	
--	--

2. Loosen the four M4x12 rounded head screws from the cover.

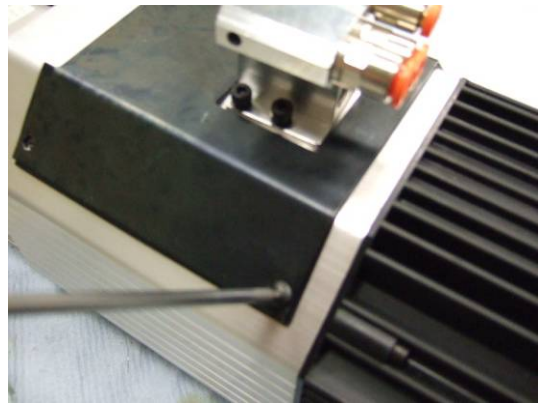

3. Carefully lift the cover and the pneumatic connections block, and detach the pressurisation tube. Be especially careful not to lose the ORs that are beneath the block.

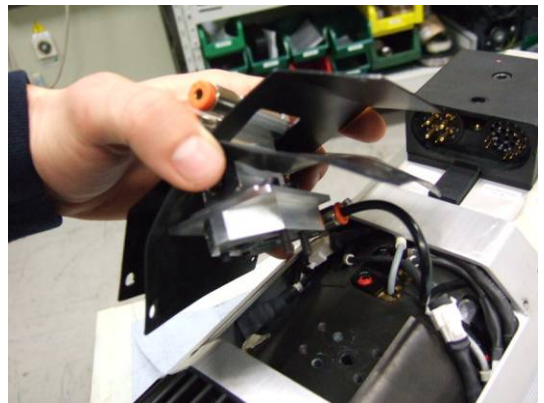

4. Remove the heat-shrinking sheath from the electrical connector of the electric fan; disconnect the electric fan connector.

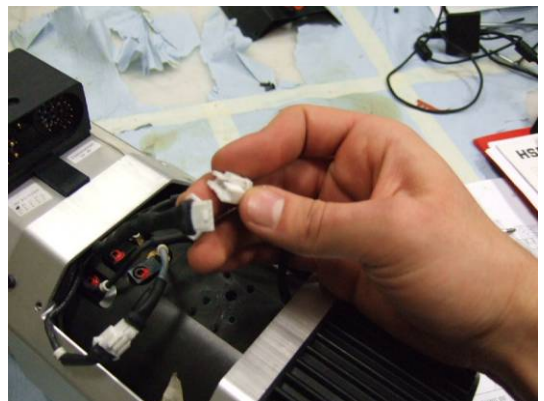

5. Loosen the four M4 screws of the fan casing, then remove it.

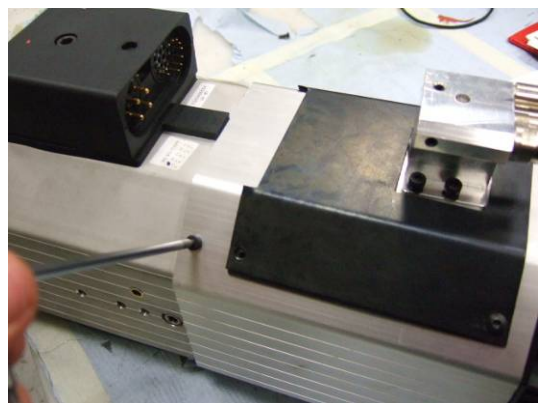

6.

Remove the eight M5x120 fixing screws from the cylinder unit.

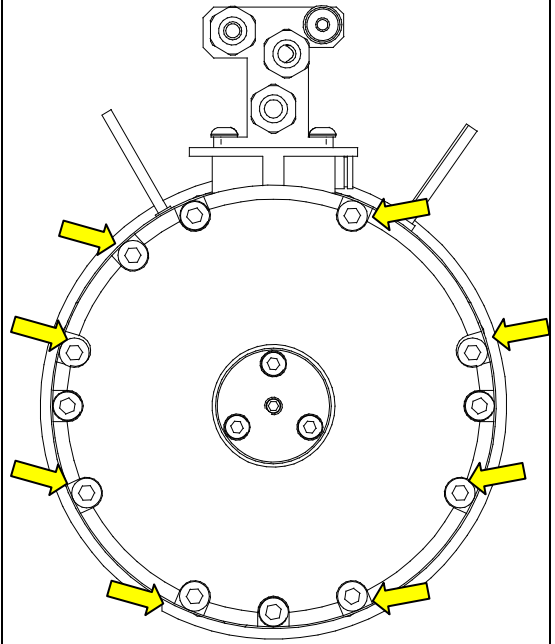

7.

The cylinder is fixed with "Loctite 510" sealing paste,
for an easier disconnection:
- hold the cylinder unit firmly
- feed it with max. 2 bar.

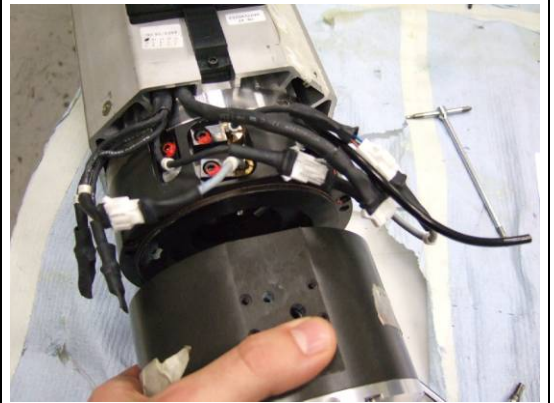

8.6.2 Disassembly of shaft kit and phonic wheel

8.

Disassemble the encoder reader by loosening the two M4x10 screws.



9. Disassemble the phonic wheel by loosening the fixing screws then extracting it, being careful not to dirty it or knock it.



10. Loosen the eight M5x20 screws on the front flange.
To extract the shaft kit, insert two M6x30 (or longer) flat bit lockscrews in the extraction bores of the front flange (indicated by the red arrows).

10. **i** INFORMATION:
In the first production batch, the flange was sealed with Loctite 510 and there are no extraction bores: the extraction operation may therefore be difficult.
In this case, contact HSD.

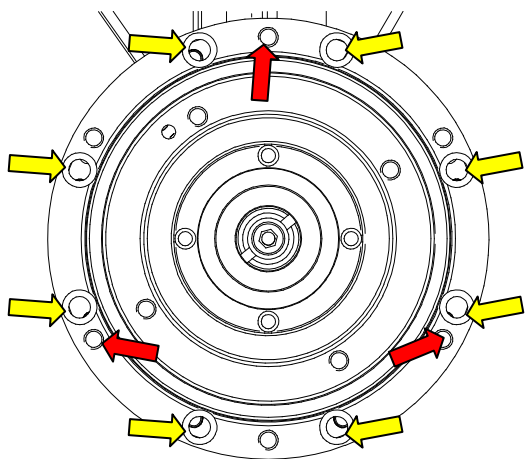





11. Unthread the old shaft kit and insert the new one, taking care to align the two pressurisation air passage bores on the front flange and on the framework.
NB: Lubricate the seats and the ORs as described in points 3-5 of the procedure for the model without encoder.

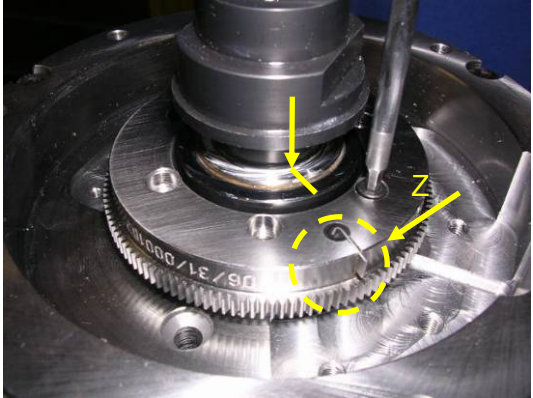

12. Tighten the M5x20 screws (of a material with a resistance class of 12.9) on the front flange, using a tightening torque of 10 Nm



<p>Reassemble the phonic wheel.</p> <p> Warning: Align the tang of the “Z” zero with the notch on the shaft. After fixing the phonic wheel, check that the dynamic balancing level at maximum speed is G=2.5 or better. If this is not the case, contact HSD.</p> <p>13.</p>	
<p>To assemble the encoder reader at the right distance, insert a 0.2mm thickness spacer between the reader itself and the phonic wheel. Block with two 4x10 screws and Z5 knurled washers, then remove the thickness spacer.</p> <p>14.</p>	
<p>Before reassembling the cylinder, check (on the machine) the encoder is working.</p> <p>15.</p>	
<p>Replace the layer of Loctite 510 (or equivalent) on the cylinder area.</p> <p>16.</p>	
<p>Reassemble the cylinder and follow steps 7-1 (i.e. in reverse order) to completely reassemble the spindle.</p> <p>17.</p>	
<p>18. Carry out the sensor calibration procedure.</p>	

HSD

8.7 REPLACING THE ENCODER READERS

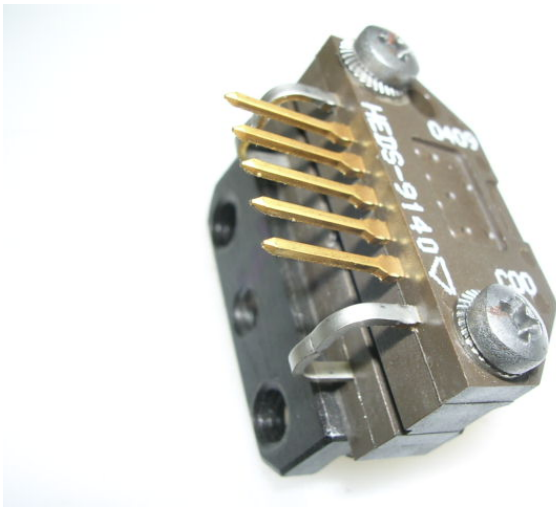

HSD optical reader
(square wave)



Lenord Bauer magnetic reader
(sinusoidal wave)

If the encoder is not working correctly, you can replace the HSD optical reader



To replace the Lenord Bauer magnetic encoder reader, contact HSD Customer Service.

8.7.1 Replacing the HSD optical encoder reader



1. Loosen the four 4x25 screws of the encoder box





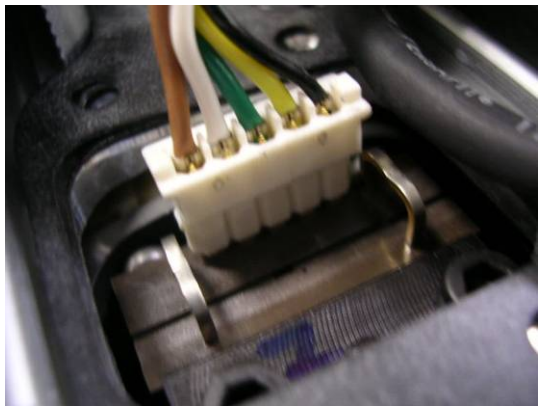
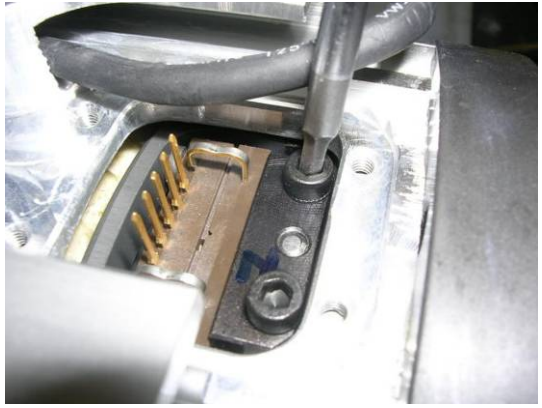

2. Loosen the four 4x10 screws of the encoder cable manifold and remove it from its seat



HSD

<p>3. Detach the encoder connector</p>	
<p>4. Loosen the two 3x8 screws of the encoder reader bracket. Disassemble the bracket-encoder reader assembly.</p>	
<p>5. Assemble the new bracket-encoder reader assembly</p>	
<p>6. Block with two 3x8 screws + a knurled washer</p>	

HSD

<p>7. Insert the manifold gasket</p>	 A close-up photograph showing a black manifold gasket being inserted into a metal housing. The gasket has a blue number '7' written on it. The housing is silver and has several screws visible.
<p>8. Connect the connector to the encoder reader, ensuring the black wire is on the right</p>	 A close-up photograph showing a white connector with several colored wires (orange, green, yellow, black) being connected to an encoder reader. The black wire is on the right side of the connector.
<p>9. Insert the encoder cable manifold in the appropriate cavity</p>	 A close-up photograph showing a hand inserting a black manifold into a cavity in a metal housing. The manifold has a blue number '5' written on it. The housing is silver and has several screws visible.
<p>10. Block the encoder electrical box with four 4x25 lowered head screws, using Loctite 510 and a copper washer</p>	 A close-up photograph showing a hand using a screwdriver to block the encoder electrical box. The box is silver and has a blue number '5' written on it. The hand is using a screwdriver to tighten a screw into the box. There are several colored wires (red, green, yellow, black) connected to the box.

HSD

11. Block the encoder cable manifold with four 3x10 screws + a knurled washer

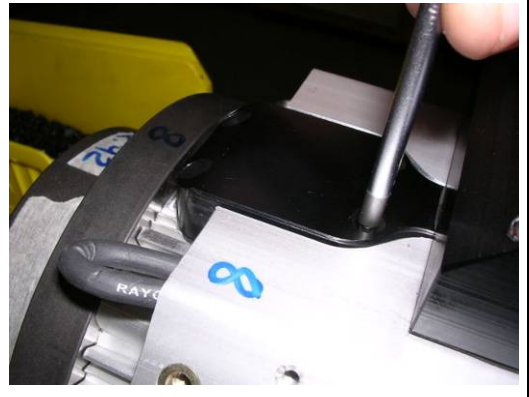

8.8 REPLACING THE SENSORS

8.8.1 Wiring the sensors of ISO30 models with single-acting piston

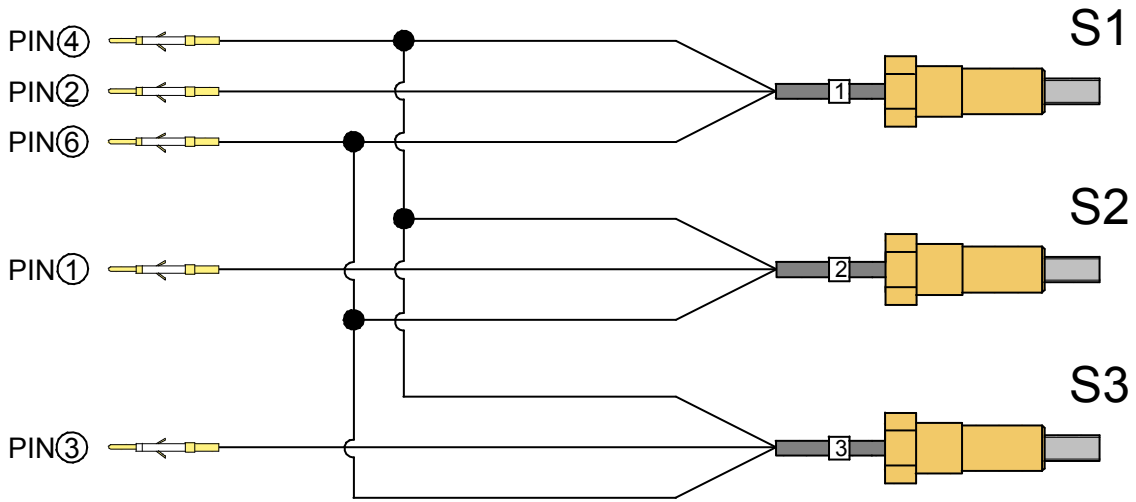

Figure 8.1 connection of the sensors of the ISO30 versions to the PINs of the signals connector

8.8.2 Wiring the sensors of HSK models with single-acting piston

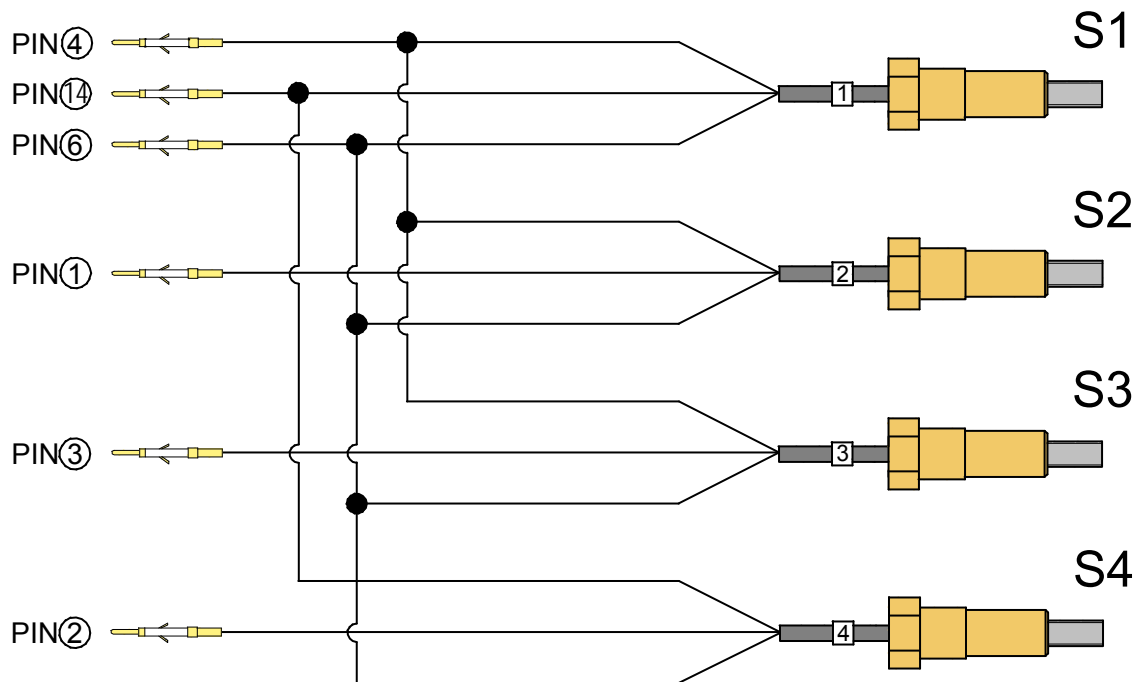

Figure 8.2 connection of the sensors of the HSK versions to the PINs of the signals connector



NOTE FOR HSK VERSIONS: the output on PIN “14” must not be used to control the machine, but only to identify the faulty sensor of the <S1+S4> range in the event of malfunctioning, and to calibrate sensor S1 as described in paragraphs 8.8.13 and subsequent.

8.8.3 Wiring the sensors of ISO30 models with double-acting piston

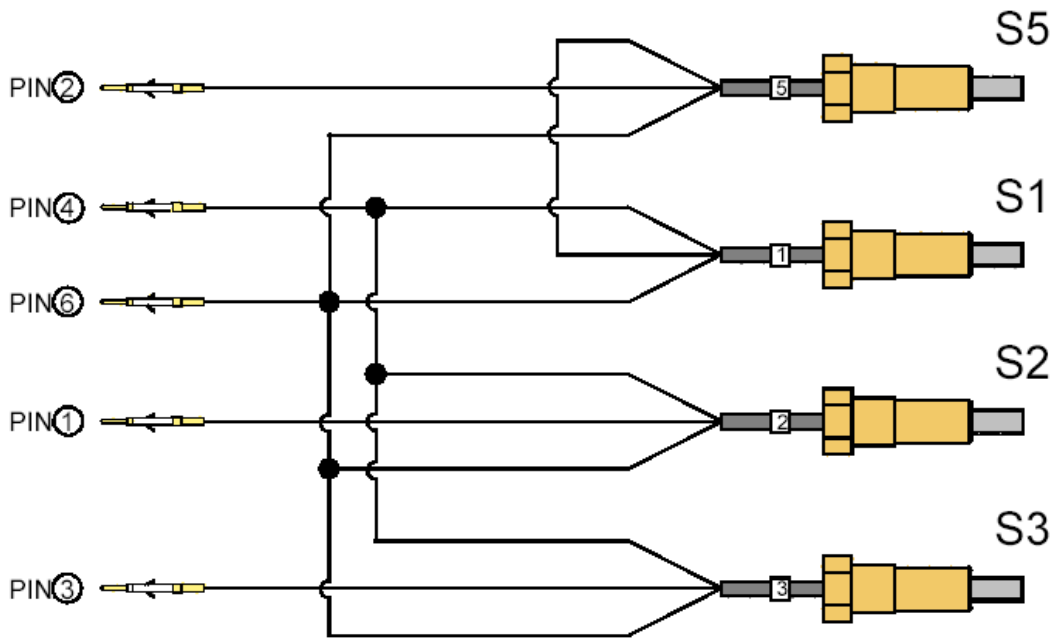

Figure 8.3 connection of the sensors of the ISO30 versions to the PINs of the signals connector

8.8.4 Wiring the sensors of HSK models with double-acting piston

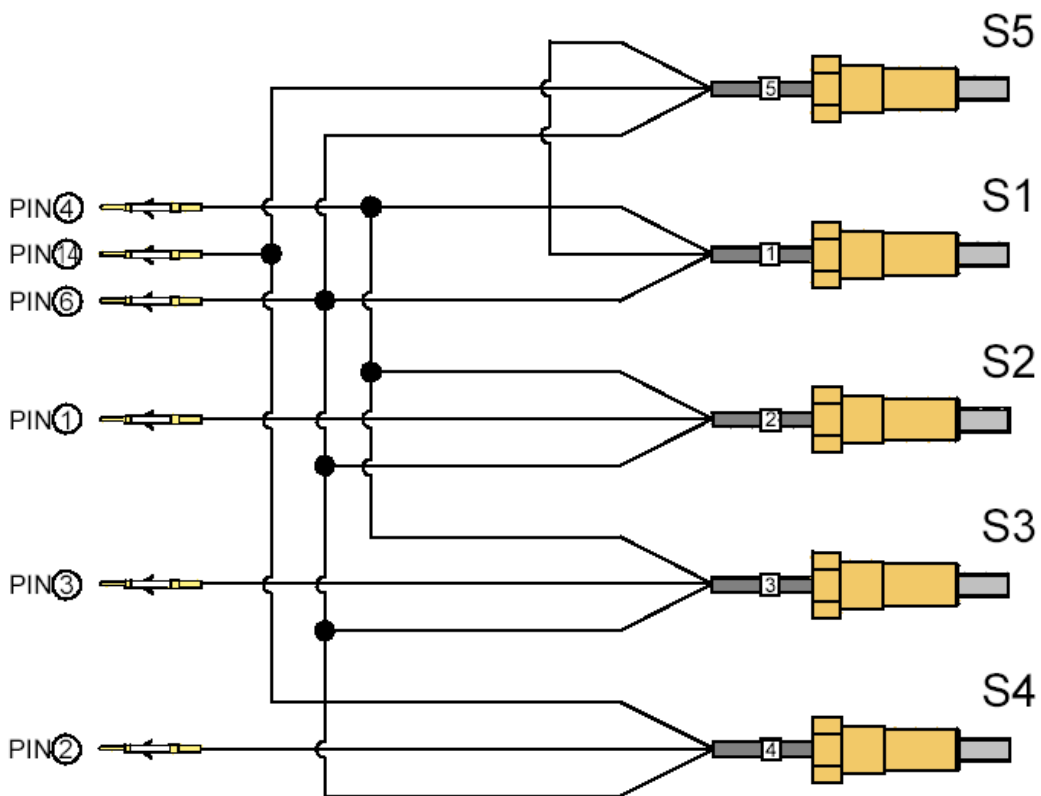

Figure 8.4 connection of the sensors of the HSK versions to the PINs of the signals connector



NOTE FOR HSK VERSIONS: the output on PIN "14" must not be used to control the machine, but only to identify the faulty sensor of the <S1+S4> range in the event of malfunctioning, and to calibrate sensor S1 as described in paragraphs 8.8.13 and subsequent.

8.8.5 Wiring the sensors of HSK models with boosted mounting plate

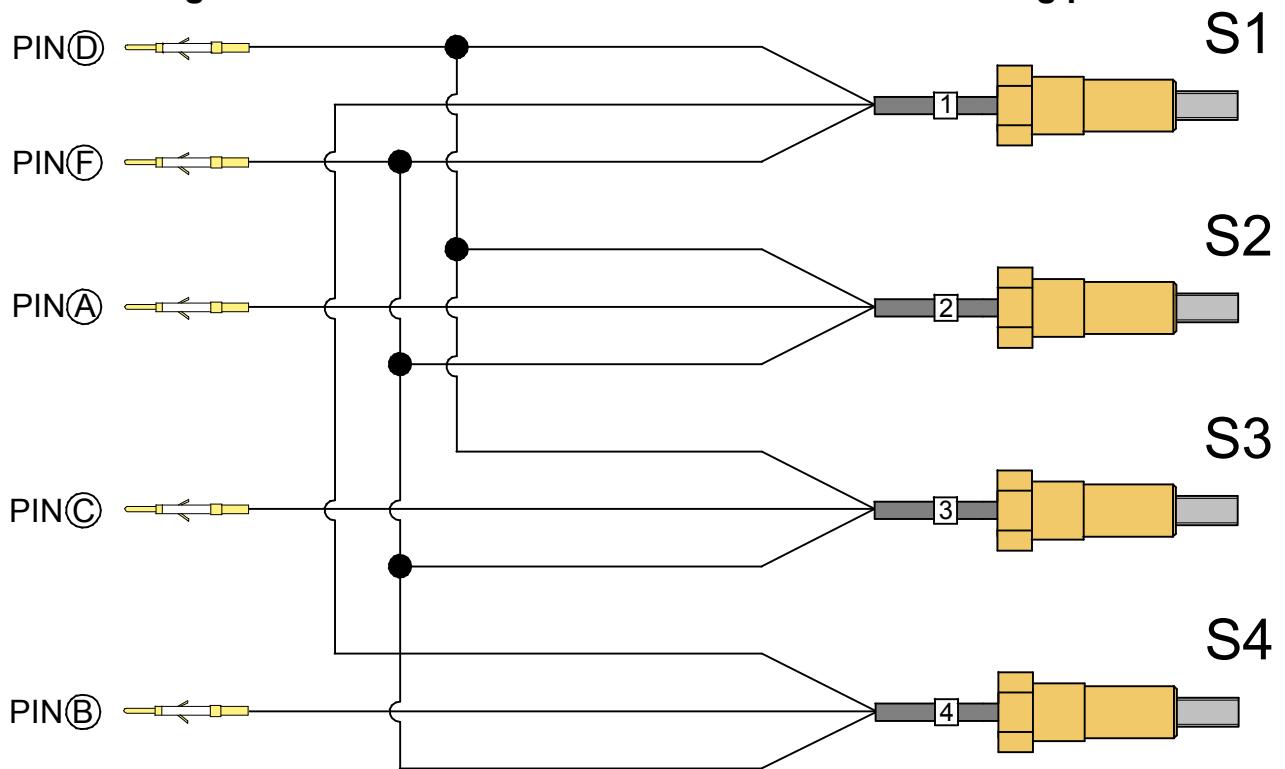

Figure 8.5 connection of the sensors of the HSK versions to the PINs of the signals connector

8.8.6 Accessing the sensors

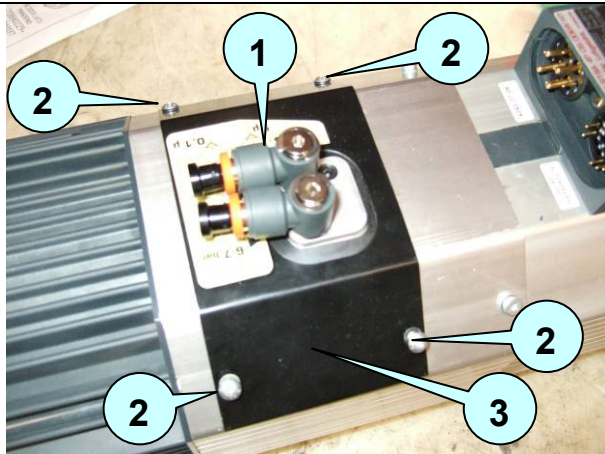

Figure 8.6.

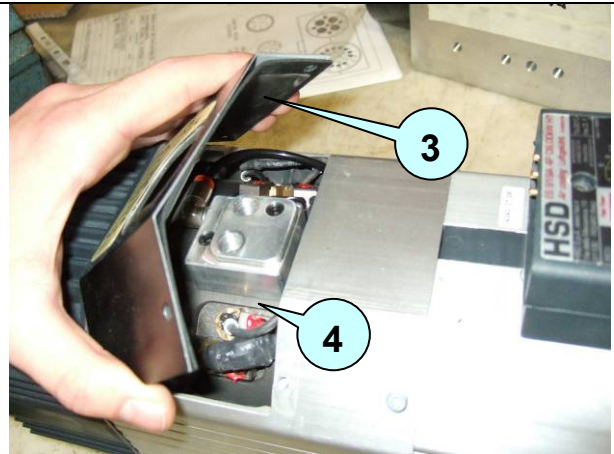

Figure 8.7

1 Pair of quick connectors	3 Sensor area cover
2 Screws	4 Sensor area

- Disconnect the quick connectors 1 from the tubes and rotate them towards the spindle nose.
- Loosen the screws 2 to free the cover 3.
- Lift up the cover 3 to access the area 4, being careful not to damage the interposed gasket.

8.8.7 Position of the sensors

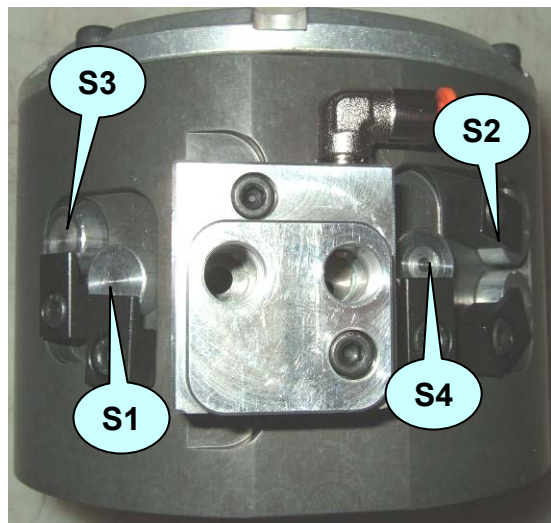

Figure 8.8 identification of the sensors

8.8.8 Accessing the ES939 sensors

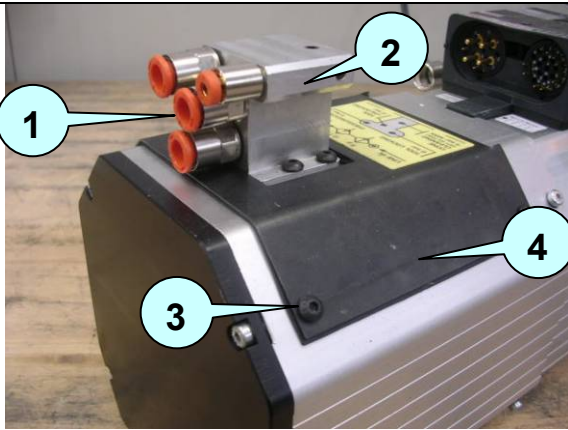

Figure 8.9

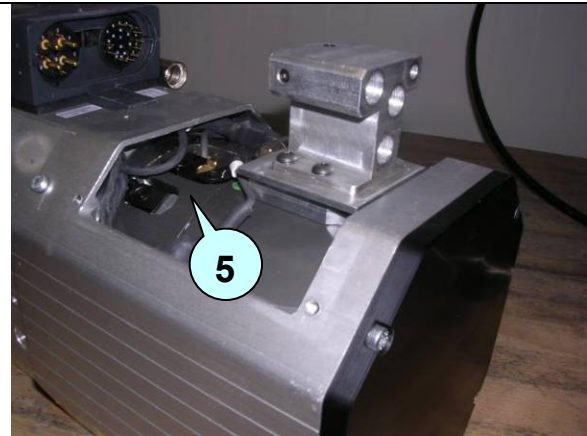

Figure 8.10

1 Quick connectors	4 Sensor area cover
2 Pneumatic block	5 Sensor area
3 Sensor cover screws	

- Disconnect the quick connectors 1 from the tubes;
- Loosen the four 4 connectors 1 from the pneumatic block 2
- Loosen the four screws 3 to free the cover 4.
- Lift up the cover 4 to access the area 5, being careful not to damage the interposed gasket.

8.8.9 Position of the ES939 sensors

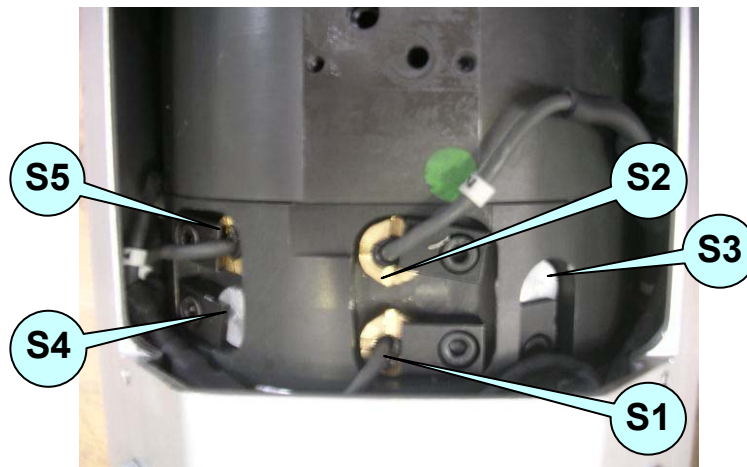
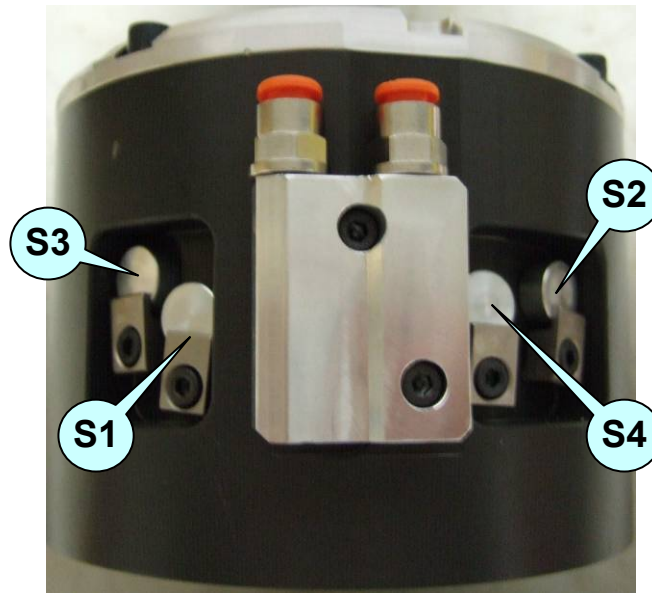



Figure 8.11 identification of the sensors

8.8.10 Position of the sensors in models ES884/ES888



8.8.11 Description of the sensor unit

	<p>The various sensors are identified by the number shown on the cable marking label; danger of damage to moving parts if sensors are swapped over.</p>
--	---

The sensors are pre-assembled in calibrated bushes to allow simple insertion to the right depth in the electrospindle.

It is therefore important to correctly identify the sensor to be replaced: for this reason, both the sensors installed on the electrospindle and those supplied as spare parts bear a numbered cable marking hose clamp (812).

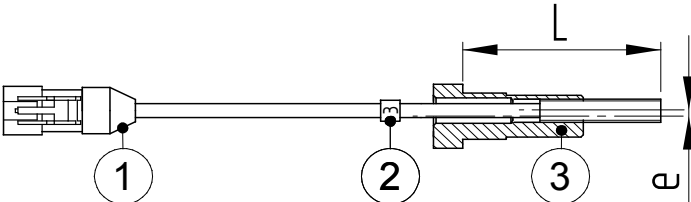
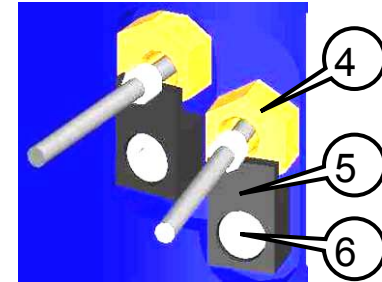
	
Figure 812.sensor unit	Figure8 13.

1	Electrical connector	E	Eccentricity for adjustment
2	Cable marking label	4	Sensor
3	Bush and sensor	5	Sensor blocking bracket
L	Calibrated position	6	Embedded hexagon screw

8.8.12 Replacing the sensor unit



To replace and adjust the sensors illustrated in this and following paragraphs, refer again to 812 and Figure 8.13..

1. Remove the screw (6) that blocks the bracket (5) of the sensor to be replaced (4).
2. Unthread the faulty sensor unit from its seat, and disconnect its electrical connector (1).
3. Connect the electrical connector of the new sensor unit.
4. Check the functioning of the new sensor by bringing it into contact with a metallic mass;
5. Position the replacement sensor in the empty seat.
6. Reposition the bracket (5) and tighten the screw (6) without blocking it completely, so that the sensor can rotate, allowing the calibration operations described in the following paragraphs.
7. After calibration, tighten the screw, blocking the sensor with an open-end spanner so as to maintain the calibration carried out.



Do not grasp the sensor by the cable or the electrical connector!

To rotate it, use a monkey wrench measuring 12



To check the effectiveness of the adjustment, perform the maximum possible number of tests with all the tool-holders available.



Warning: an incorrect calibration of the sensors can cause irregularities in the functioning of the electrospindle.

8.8.13 Adjusting sensor S1 (both ISO and HSK versions)



Only for HSK versions: for the adjustment of HSK F63 sensors, a kit of gauges and thickness spacers is available, described in section 8.8.18.

The use of the kit allows a quicker and more precise adjustment: HSD S.p.A. strongly recommends the use of the kit, given the importance (for safety purposes) of a correct sensor adjustment.

After replacing the sensor as described in paragraph 8.8.12, calibrate it as follows:

1. insert the tool-holder cone and ensure that the output of S1 is **"ON"**
if the output is **"OFF"**, rotate the sensor unit until it becomes **"ON"**;
2. rotate the bush slowly in the direction that takes the sensor away from the tool-holder;
stop immediately when the output of the sensor becomes **"OFF"**;
3. carefully rotate the bush back by about 15° - 20°, so that the output of the sensor returns to **"ON"**;
4. rotate the shaft manually, and check that the signal remains **"ON"** for the whole rotation;
5. tighten the screw (3);
6. unhook the tool-holder by powering the cylinder, and check that in this condition (collet open) the output of S1 is **"OFF"**;
7. by means of the cylinder, let the collet close without a tool-holder: in this condition, the output of S1 must be **"OFF"** for the whole rotation of the shaft;
8. if points [6] and [7] are not satisfied, repeat the procedure from the start, making an even slighter rotation movement at point [3];
9. if points [6] and [7] are satisfied, make a cycle of 10 tool changes;
10. at the end of the cycle, check that the conditions in the following table are satisfied:

CONDITION	S1 OUTPUT
tool-holder locked	ON *
missing tool-holder with closed collet	OFF *
collet open (tool-holder ejected)	OFF

* for the whole rotation of the shaft

11. If the conditions of the table **are not satisfied**, repeat the procedure from the start.
12. If the conditions of the table **are satisfied**, perform a cycle of 100 tool changes with the machine, using the maximum possible number of different tool-holders.
13. At the end of the cycle, check that the condition of the table at point [10] is satisfied. if this is the case, the adjustment procedure for S1 is completed; if this is not the case, repeat the procedure from the beginning.

8.8.14 Adjusting sensor S2 in ISO versions

After replacing the sensor as described in paragraph 8.8.12, calibrate it as follows:

1. correctly attach a tool-holder before beginning the adjustment of the sensor;
2. check that, in this state, the output of S2 is “OFF”; if the output is “ON”, rotate the sensor unit until it becomes “OFF”;
3. feed the air input for a tool change of the cylinder, using a one-way pressure regulator initially set at 0 bar;
4. gradually increase the feed pressure so as to move the piston slowly forward and, at the same time, check that the output of S2 is “OFF”;
5. as long as the tool-holder is firmly blocked, the output of S2 must be “OFF”; if the output changes during the movement of the piston, slightly rotate the sensor unit until the output returns to “OFF”;
6. when the tool-holder begins to slacken (but is not yet free to fall), the output of S2 must still be “OFF” (if necessary, rotate the sensor unit);
7. when you reach the feed pressure at which the tool-holder is finally free to fall, increase the pressure by another 0.2 bar and block the pressure regulator;
8. rotate the sensor unit so that, in this state, the output of S2 is “ON”, then fix it by tightening the screw (3);
9. perform a cycle of 10 tool changes;
10. at the end of the cycle, check that the steps from [1] to [8] are satisfied, without the need to ever rotate the sensor;
11. if the outputs requested are not satisfied, repeat the entire procedure from the start;
12. if the outputs requested are satisfied, perform a cycle of 100 tool changes with the machine, using the maximum possible number of different tool-holders;
13. at the end of the cycle, check that the steps from [1] to [8] are satisfied, without the need to ever rotate the sensor;
14. if the outputs requested are not satisfied, repeat the entire procedure from the start;
15. if the outputs requested are satisfied, the regulation procedure for S2 is complete.

8.8.15 Adjusting sensor S2 in HSK versions

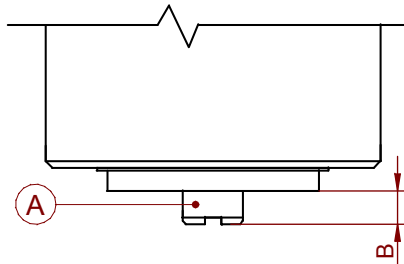

	B1	B2
HSK E25	6.5	6.35
HSK E40/F50	8.5	8.35
HSK E50/F63	10.5	10.3
HSK E63/F80	10.5	10.3

(+/- 0.1mm)

Figure 8 14. position of the expeller

Figure 8 15. (A) expeller
(B) reference position

Table 8.1: values of (B)

After replacing the sensor as described in paragraph 8.8.12, calibrate it as follows:

- bring the spindle to the state of "Collet open (tool-holder cone expelled)" by powering the cylinder; in these conditions, the position (B) (figure Figure 8 14.) takes on the maximum value;
- as shown in figures Figure 8 14. and Figure 8 15., use a depth gauge to check that the position (B) of the expeller in relation to the spindle nose takes on the value "B1" indicated in table Table 8.1; if this is not the case, stop and contact HSD Customer Service;
- by means of the cylinder, bring the piston to the upper end stop and make position (B) adopt the minimum value;
- power the cylinder by means of a one-way pressure regulator initially set at 0 bar;
- gradually increase the feed pressure so as to move the piston slowly forward, stopping when the position (B) reaches the value "B2";
- rotate sensor S2 until you find the position supplying the signal "ON" with $(B) > B2$ and "OFF" with $(B) < B2$;
- definitively tighten the screw (3);
- perform a cycle of 10 tool changes;
- at the end of the cycle, check that point [6] is satisfied without the need to rotate the sensor;
- if it is necessary to rotate the sensor, then repeat the whole procedure from the beginning;
- if it is not necessary to rotate the sensor, perform a cycle of 100 tool changes with the machine, using the maximum possible number of different tool-holders;
- at the end of the cycle, check that point [6] is satisfied without the need to rotate the sensor;
- if it is necessary to rotate the sensor, then repeat the whole procedure from the beginning;
- if it is not necessary to rotate the sensor, then the S2 adjustment procedure is complete.

8.8.16 Adjusting sensor S3 (both ISO and HSK versions)

After replacing the sensor as described in paragraph 8.8.12, calibrate it as follows:

- check that the signal from the sensor corresponds to that described in the figure below

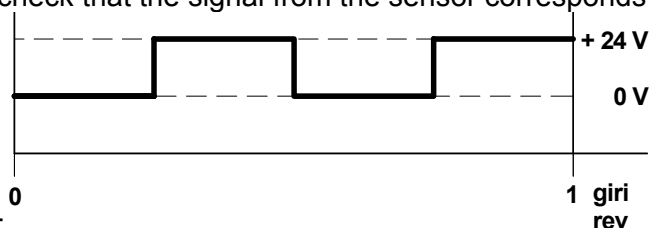

- if this is not the case, rotate the bush (4) until you find the position that permits you to have the output described in the above-mentioned table, then definitively tighten the screw (6).

8.8.17 Adjusting sensor S4 (HSK versions only)

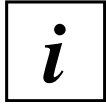

Only for HSK versions: for the adjustment of HSK F63 sensors, a kit of gauges and thickness spacers is available, described in section 8.8.18. The use of the kit allows a quicker and more precise adjustment: HSD S.p.A. strongly recommends the use of the kit, given the importance (for safety purposes) of a correct sensor adjustment.

After replacing the sensor as described in paragraph 8.8.12, calibrate it as follows:

1. take thickness spacers of 0.12mm and 0.16mm, which will be interposed between the stop surfaces of the tool-holder cone and the spindle shaft, as shown in the figure below;
2. insert and block the tool-holder cone in the spindle, and check that the signal supplied by sensor S4 corresponds to that described in the following table:

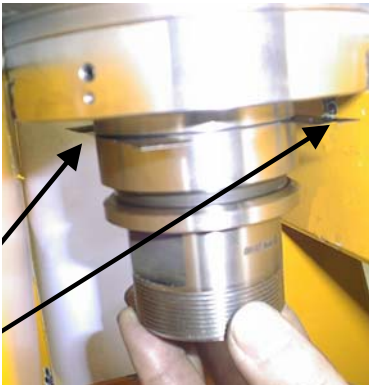

CONDITION	THICKNESS SPACER INTERPOSED	S4 OUTPUT
Tool-holder blocked	0.12mm	ON
Tool-holder blocked	0.16mm	OFF
Tool-holder expelled (collet open)		OFF

Figure8 16.

3. rotate the shaft manually and check that the conditions of the table are satisfied for all 360° of the rotation;
4. if this is not the case, rotate the sensor until you find the position at which you obtain the output described in the table;
5. definitively tighten the screw (3);
6. perform a cycle of 10 tool changes;
7. at the end of the cycle, check that the condition in point [2] of the table is satisfied for all 360° of the rotation of the shaft; if this is not the case, repeat the procedure from the start;
8. if the conditions of the table are satisfied, perform a cycle of 100 tool changes with the machine, using the maximum possible number of different tool-holders;
9. at the end of the cycle, check that the condition in point [2] of the table is satisfied for all 360° of the rotation of the shaft; if this is not the case, repeat the procedure from the start;
10. if the condition in point [2] of the table is satisfied, the adjustment of S4 is complete.

8.8.18 Kit of gauges to adjust sensors S1 and S4 HSK F63 (code HSD 3811H0110)

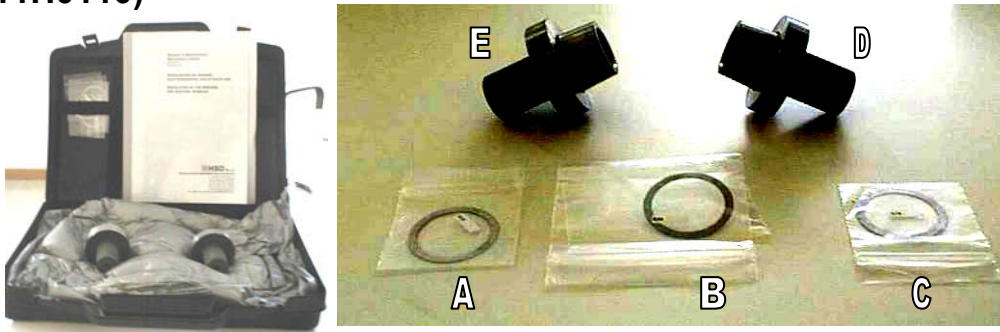

A	Thickness spacer for adjusting sensor S1 (0.04mm)
B	Thickness spacer for adjusting sensor S4 (0.12mm)
C	Thickness spacer for adjusting sensor S4 (0.16mm)
D	Gauge for adjusting sensor S1 (14.29mm)
E	Gauge for adjusting sensor S4 (14.13mm)

Figure 8.17 kit for sensors F63 code HSD 3811H0110

For the F63 version of the HSK spindles, the kit of gauges code HSD 3811H0110 is available. The use of the gauges allows the immediate positioning of the HSK collet in the position in which the sensors are regulated, thus allowing an adjustment that is not only quicker but also more precise, given that the gauges have been produced with stricter tolerances compared with the normal tool-holders.

Although it is possible to carry out the adjustment of the sensors without using the kit as described in the previous paragraphs, HSD strongly recommends the use of the kit, in view of the importance (for safety purposes) of the accurate adjustment of the sensors.

The gauges and thickness spacers shown in Figure 8.17 are identified by the indication of the thickness spacer engraved on their surface, or shown on their packaging label.



Figure 8.18 use of the gauge as a normal tool-holder, with or without interposed thickness spacer (Figure 8.19), according to the indications of the table shown in the procedures of paragraphs 0 and 0

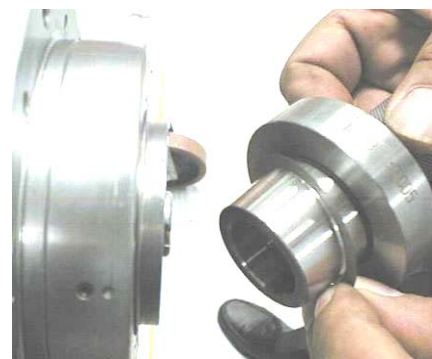

Figure 8.19 interposition of the thickness spacer between the stop surfaces of the gauge and of the spindle shaft

Procedure for S1

After replacing the sensor as described in paragraph 8.8.12, calibrate it as follows:

1. Use the **gauge of 14.29mm** and the thickness spacer **of 0.04mm**, as shown in Figure 8.18 and Figure 8.19, and check that the signal supplied by sensor S1 corresponds to that described in the following table:

CONDITION	THICKNESS SPACER INTERPOSED	S1 OUTPUT
Gauge blocked (tool-holder blocked)	YES	HIGH (+24V)
Gauge blocked (tool-holder blocked)	NO	LOW (0V)
Gauge missing (tool-holder missing)	-	LOW (0V)
Collet open (tool-holder expelled)	-	LOW (0V)

2. Rotate the shaft manually and check that the conditions of the table are satisfied for all 360° of the rotation.
3. If this is not the case, rotate the bush (4) until you find the position that permits you to have the output described in the above-mentioned table, then definitively tighten the screw (6).
4. Check the effectiveness of the adjustment by performing the maximum possible number of tests with all the tool-holders available.

Procedure for S4

After replacing the sensor as described in paragraph 8.8.12, calibrate it as follows:

1. Use the **gauge of 14.13mm** and the **thickness spacers of 0.12 and 0.16mm**, as shown in Figure 8.18 and Figure 8.19, and check that the signal supplied by sensor S4 corresponds to that described in the following table:

CONDITION	THICKNESS SPACER INTERPOSED	S1 OUTPUT
Gauge blocked (tool-holder blocked)	0.12mm	HIGH (+24V)
Gauge blocked (tool-holder blocked)	0.16mm	LOW (0V)
Collet open (tool-holder expelled)	-	LOW (0V)

2. Rotate the shaft manually and check that the conditions of the table are satisfied for all 360° of the rotation.
3. If this is not the case, rotate the bush (4) until you find the position that permits you to have the output described in the above-mentioned table, then definitively tighten the screw (6).
4. Check the effectiveness of the adjustment by performing the maximum possible number of tests with all the tool-holders available.

8.8.19 Kit of gauges to adjust sensors S1 and S4 HSK E63 (code HSD 3811H0739)

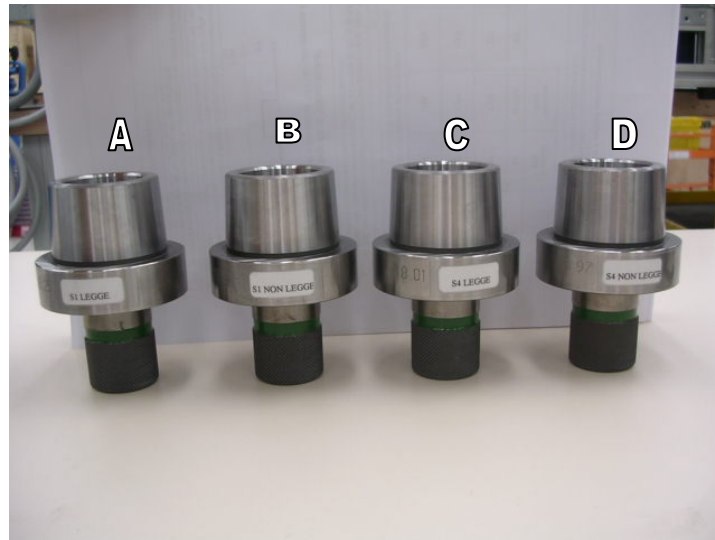

A	3811H0354 gauge sensor 1 READS (Q=18.25mm)
B	3811H0357 gauge sensor 1 DOES NOT READ (Q=18.29mm)
C	3811H0356 gauge sensor 4 READS (Q=18.01mm)
D	3811H0355 gauge sensor 4 DOES NOT READ (Q=17.97mm)

Figure 8.20 kit for sensors E63 code HSD 3811H0739

For the E63 version of the HSK spindles, the kit of gauges code HSD 3811H0739 is available. The use of the gauges allows the immediate positioning of the HSK collet in the position in which the sensors are regulated, thus allowing an adjustment that is not only quicker but also more precise, given that the gauges have been produced with stricter tolerances compared with the normal tool-holders.

Although it is possible to carry out the adjustment of the sensors without using the kit as described in the previous paragraphs, HSD strongly recommends the use of the kit, in view of the importance (for safety purposes) of the accurate adjustment of the sensors.

The thickness spacers shown in Figure 8.17 are identified by the indication of the thickness engraved on their surface, or shown on their packaging label.

Procedure for S1

After replacing the sensor as described in paragraph 8.8.12, calibrate it as follows:

1. Insert the gauge S.1 DOES NOT READ in the spindle cone.
2. Manually rotate (with the help of a screwdriver) the sensor in question (S1) until the cone presence signal indicates ON on the NC (after slightly loosening its fixing screw - M4 screw of the block).
3. Slowly draw back, in the opposite direction, until the cone presence signal indicates OFF.
4. Insert the gauge S1 READS and check the signal remains high (ON).

WARNING:

Rotating the spindle, the cone presence signal must always remain high (ON)

5. If the outcome is positive, move on to point 7.
6. If the signal is OFF or intermittent, rotate the sensor again until you obtain a high (ON) signal for the entire rotation.
7. Insert the gauge S.1 DOES NOT READ again, and check that the signal is low (OFF) or at least intermittent when the shaft is rotated.
8. If the condition requested in the above point is not satisfied, go back to point 1 and restart the procedure.

Procedure for S4

After replacing the sensor as described in paragraph 8.8.12, calibrate it as follows:

1. Insert the gauge S4 DOES NOT READ in the spindle cone.
2. Manually rotate (with the help of a screwdriver) the sensor in question (S4) until the cone presence signal indicates ON on the NC (after slightly loosening its fixing screw - M4 screw of the block).
3. Slowly draw back, in the opposite direction, until the cone presence signal indicates OFF.
4. Insert the gauge S4 READS and check the signal remains high (ON).

ATTENTION:

Rotating the spindle, the cone presence signal must always remain high (ON)

5. If the outcome is positive, move on to point 7.
6. If the signal is OFF or intermittent, rotate the sensor again until you obtain a high (ON) signal for the entire rotation.
7. Insert the gauge S.4 DOES NOT READ again, and check that the signal is low (OFF) or at least intermittent when the shaft is rotated.
8. If the condition requested in the above point is not satisfied, go back to point 1 and restart the procedure.

9 OPTIONAL PARTS

9.1 COOLING WITH FORCED AIR

As an alternative to the electric fan, the electrospindle can be cooled by using the air of the pneumatic circuit.

The pressurised air is channelled through a distribution flange, available both pre-assembled by HSD and as a transformation kit.

The plate is available for models ES915, 919, 929, 939, 983 and 988.

This solution reduces the length of the electrospindle by 5cm and also allows you to eliminate the clearance (10cm) necessary for the flow of air to the fan: the overall dimensions of the electrospindle are therefore reduced by 15cm (Figure9 1.).

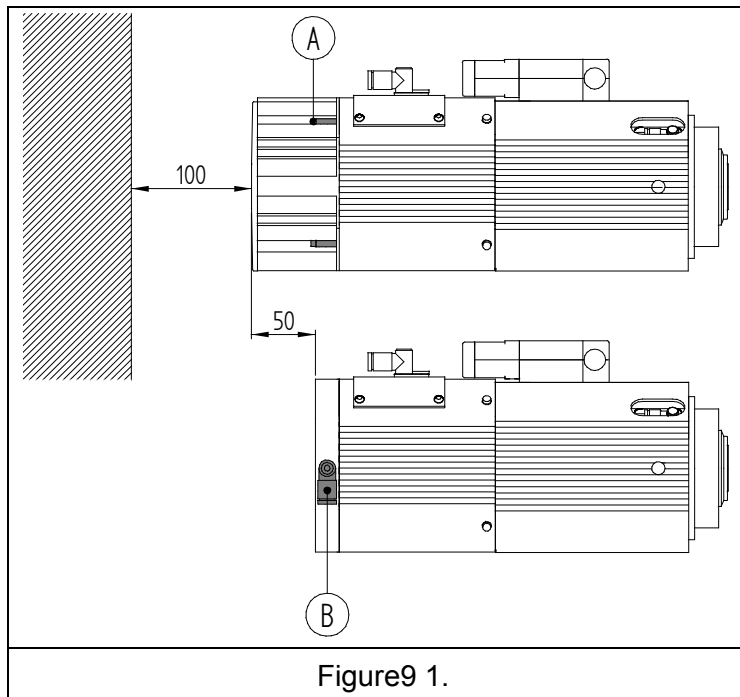

Figure9 1.

A	Four screws for fixing the electric fan	
B	Cooling air input	Ø external tube: 8mm
		pressure: 6/7 bar - 85/100 PSI
		consumption: 7000 normal litres / hour



The values indicated for the air consumption and input pressure relate to Service S1 described in the tables of chapter 3. For less heavy services, the user can evaluate whether to reduce the air consumption by lowering the input pressure.

9.2 INSTALLATION OF THE KIT FOR COOLING WITH FORCED AIR



BEFORE STARTING WORK ON THE ELECTROSPINDLE, READ AND IMPLEMENT ALL THE WARNINGS AND RECOMMENDATIONS RELATED TO SAFETY AND MAINTENANCE. REFER IN PARTICULAR TO CHAPTERS 1.4 AND 7.

1. Loosen the four screws (A) and move the electric fan in an axial direction (see paragraph 8.1).
2. Disconnect the electrical connector of the electric fan from the electrospindle and, in its place, connect the jump connector supplied with the kit.
3. Place the air distribution flange in the place of the electric fan and fix it with the four screws that blocked the electric fan.
4. Connect the air distribution flange to the pneumatic circuit with the quick connector (B).

10 TROUBLESHOOTING



BEFORE STARTING WORK ON THE ELECTROSPINDLE, READ AND IMPLEMENT ALL THE WARNINGS AND RECOMMENDATIONS RELATED TO SAFETY AND MAINTENANCE.

PROBLEMS	CAUSES	SOLUTIONS
<p>The electrospindle does not rotate:</p>	<p>No power supply:</p>	<ul style="list-style-type: none"> • Check for mains voltage; • Check the connectors; • Check the integrity and continuity of the electric connections.
	<p>The tool-holder is not inserted:</p>	<p>Insert a tool-holder.</p>
	<p>The tool-holder is not inserted correctly:</p>	<p>See the item "<i>The tool-holder is not locked</i>" in this same chapter.</p>
	<p>The thermal protective device has tripped:</p>	<p>Wait for the electrospindle to cool down: the thermal protective device is reset automatically If the thermal protective device trips frequently, consult the item "<i>The electrospindle overheats</i>" further on in this same chapter.</p>
	<p>The sensor S1(ISO30) or the series of sensors <S1+S4>(HSK) are disconnected or faulty:</p>	<ul style="list-style-type: none"> • Check the connectors; • Check the integrity and continuity of the electrical connectors; • Carry out the adjustment of the sensor as described in paragraph 8.8 • If necessary, replace the faulty sensor as described in paragraph 8.8

The tool-holder is not locked:	Foreign body between tool-holder and spindle shaft:	Remove the foreign matter and clean as described in section 7
	The tool-holder cone is not of the required type:	Choose a tool holder according to the indications in paragraph 6.6
	The collet does not open due to lack of pressure:	<ul style="list-style-type: none"> • Check the required pressure values indicated in paragraph 4.4 • Check the integrity and efficiency of the pneumatic circuit.
	Sensor S2 is disconnected or faulty:	<ul style="list-style-type: none"> • Check the connectors; • Check the integrity and continuity of the electrical connectors; • Carry out the adjustment of the sensor as described in paragraph 8.8 • If necessary, replace the faulty sensor as described in paragraph 8.8
The tool-holder is not expelled:	Insufficient pressure:	<ul style="list-style-type: none"> • Check the required pressure values indicated in paragraph 4.4 • Check the integrity and efficiency of the pneumatic circuit.
Lack of pressurisation:	Insufficient pressure or inefficient pneumatic circuit:	<ul style="list-style-type: none"> • Check the required pressure values indicated in paragraph 4.4 • Check the integrity and efficiency of the pneumatic circuit; • Contact HSD Customer Service.
One of the sensors does not provide the required output:	Sensor disconnected or faulty:	<ul style="list-style-type: none"> • Check the connectors; • Check the integrity and continuity of the electrical connectors; • Carry out the adjustment of the sensor as described in paragraph 8.8 • Replace the sensor as described in paragraph 8.8

<p>The electrospindle overheats:</p>	<p>The electric fan does not work well:</p>	<ul style="list-style-type: none"> • Check the electric fan is operational; • Check the electric fan is integral; • Check that the rotation of the electric fan is not obstructed by foreign matter; • Replace the electric fan if it is faulty, as shown in paragraph 8.1
	<p>The passages where the cooling air goes through the framework of the electrospindle are obstructed:</p>	<ul style="list-style-type: none"> • Disassemble the electric fan as shown in paragraph 8.1 • Check and free the passages where the cooling air goes through the framework of the electrospindle; • Reassemble the electric fan.
	<p>The liquid-based cooling is not effective:</p>	<ul style="list-style-type: none"> • Check the level of liquid in the circuit; • Check the specifications of paragraph 4.5 are respected; • Check the integrity and efficiency of the cooling circuit; • Consult the manual of the cooling unit.
	<p>The machining operation is too heavy:</p>	<p>Reduce the severity of the machining operation.</p>
	<p>Incorrect parameterisation of the inverter:</p>	<p>Check the parameters on the plate of the electrospindle.</p>
<p>Performance below specifications:</p>	<p>Incorrect parameterisation of the inverter:</p>	<p>Check the parameters on the plate of the electrospindle.</p>

Vibrations of the electrospindle:	The tool-holder is not balanced:	Choose a tool-holder according to the indications in paragraph 6.6
	The tool is not balanced:	Choose and use the tool according to the indications in paragraph 6.7
	Dirt between tool-holder cone and spindle shaft:	Remove the foreign matter and clean as described in section 7
	Incorrect parameterisation of the inverter:	Check the parameters on the plate of the electrospindle.
	The machining operation is too heavy:	Reduce the severity of the machining operation.
	Anchor screws loose:	Tighten the anchor screws.
	Bearings damaged:	Replace the shaft kit.
Noisy bearings:	Bearings damaged:	Replace the shaft kit.

11 LIST OF SPARE PARTS

HSD CODE	DESCRIPTION
41805006	Sensor S1(apart from ES939)
4180500601	Sensor S2 (apart from ES939)
4180500602	Sensor S3 (apart from ES939)
5664H0016	Sensor S4 (apart from ES939)
5664H0026	Sensor S5
4180500601	Sensors S1, S2, S3, S4 for ES939
6390H0001	Kit for cooling with forced air, for models ES915, 919, 929
6390H0002	Kit for cooling with forced air, for models ES983 and ES988
5661H0009	Fan kit (complete with casing and protective cover) for models ES915, 919, 929
3002A0515	TCEI M4X25 screws for fixing the fan kit 5661H0009
5661H0008	Fan kit (complete with casing and protective cover) for models ES983 and ES988
3002A0577	TCEI M4X30 screws for fixing the fan kit 5661H0008
302006100	Schnorr washer for M4 screw, for fixing the two fan kits
6200H0050	“Signal + power” mobile connector
2138A0604	“Signals” mobile connector
2138A0607	“Power” mobile connector
2138A0229	“Encoder” mobile connector
2147A0404	Straight fitting for encoder connector
2147A0137	Elbow fitting for encoder connector
1401H0011	Rubber cover (D=110) to protect the inside of the spindle
1401H0010	Rubber cover (D=100) to protect the inside of the spindle ES939
1707H0030	ISO30 cone to protect the inside of the spindle
1707H0031	HSK F63 cone to protect the inside of the spindle
2161H0022	Cooling liquid Artic-Flu-5
6394H0045	Air cooling kit for ES939 models
6394H0033	Fan kit (with carter and protection cover) for models ES939

SPARE SHAFT KIT



Spare shaft kits are available, to install in case of bearing wear.

The shaft kit has a shaft, bearings already run in, rotor, tie-rod and coupling system.

To obtain a shaft kit suitable for your own model, inform the HSD commercial office about the spindle serial number

The serial number is usually stamped on the front flange or the framework front part (see section 2)

12 DISPOSAL



Inside the electrospindle, there is a pre-loaded spring with a force of hundreds of kilograms. This spring is attached to a tie-rod that may be thrown out violently if the electrospindle is dismantled by personnel who have not been sufficiently trained.

Carry out only the operations described in this manual, paying close attention to the instructions given; if in doubt, contact the Assistance Service of HSD S.p.A.

At the end of the electrospindle lifespan, it is the responsibility of the user company to dispose of it. First of all, the various elements must be cleaned, then the various parts must be separated into components and electrical material. The different materials should be divided, e.g.: electrical motors (copper coils), metallic parts, plastic materials etc., and then disposed of separately, according to the regulations of the current laws in the country of installation.

13 ASSISTANCE

HSD S.p.A.

TECHNOLOGICAL EQUIPMENT FOR AUTOMATION

registered office:

Via della Meccanica, 16
61122 PESARO (ITALIA)
Loc. Chiusa di Ginestreto

factory headquarters:

P.le Alfio De Simoni, sn
61122 PESARO (ITALIA)

Tel. (+39)0721.205.211
Fax (+39)0721.205.247
E-mail supporthsd@hsd.it
www.hsd.it

HSD Deutschland GmbH

Brückenstrasse, 32

D-73037 Göppingen

Tel. +49(0)7161 956660
Fax +49(0)7161 9566610
E-mail supporthsddeut@hsddeutschland.de
www.hsddeutschland.de

HSD USA Inc.

3764 SW, 30th Avenue

33312 Hollywood, Florida USA

Phone no. (+1) 954 587 1991
Fax (+1) 954 587 8338
E-mail supporthsdusa@hsd.it
www.hsdusa.com

HSD Mechatronic Shanghai Co. Ltd.

D2, First floor, 207 Taigu Road

Waigaoqiao Free Trade Zone

200131, Shanghai – China

Phone no. (+86) 215866 1236
E-mail sales@hsd-china.cn
www.hsd-china.cn

